



Complies with
EASA ATPL

SKILLS · FOR · FLIGHT

ATPL GROUND TRAINING SERIES

Aircraft General Knowledge 4

Flight Instruments — Auto Flight — Warning & Recording — Engine Instruments



Complies with JAA/EASA ATPL syllabus

Created by



Suitable for students studying for the
ATPL Theoretical Examinations

Contains specimen examination and test questions and answers

5

© Oxford Aviation Academy (UK) Limited 2008
All Rights Reserved

This text book is to be used only for the purpose of private study by individuals and may not be reproduced in any form or medium, copied, stored in a retrieval system, lent, hired, rented, transmitted or adapted in whole or in part without the prior written consent of Oxford Aviation Academy.

Copyright in all documents and materials bound within these covers or attached hereto, excluding that material which is reproduced by the kind permission of third parties and acknowledged as such, belongs exclusively to Oxford Aviation Academy.

Certain copyright material is reproduced with the permission of the International Civil Aviation Organisation, the United Kingdom Civil Aviation Authority and the European Aviation Safety Agency (EASA).

This text book has been written and published as a reference work to assist students enrolled on an approved EASA Air Transport Pilot Licence (ATPL) course to prepare themselves for the EASA ATPL theoretical knowledge examinations. Nothing in the content of this book is to be interpreted as constituting instruction or advice relating to practical flying.

Whilst every effort has been made to ensure the accuracy of the information contained within this book, neither Oxford Aviation Academy nor the distributor gives any warranty as to its accuracy or otherwise. Students preparing for the EASA ATPL theoretical knowledge examinations should not regard this book as a substitute for the EASA ATPL theoretical knowledge training syllabus published in the current edition of 'CS-FCL 1 Flight Crew Licensing (Aeroplanes)' (the Syllabus). The Syllabus constitutes the sole authoritative definition of the subject matter to be studied in an EASA ATPL theoretical knowledge training programme. No student should prepare for, or is currently entitled to enter himself/herself for the EASA ATPL theoretical knowledge examinations without first being enrolled in a training school which has been granted approval by an EASA authorised national aviation authority to deliver EASA ATPL training.

Oxford Aviation Academy excludes all liability for any loss or damage incurred or suffered as a result of any reliance on all or part of this book except for any liability for death or personal injury resulting from Oxford Aviation Academy's negligence or any other liability which may not legally be excluded.

Cover Photograph: Embraer ERJ - 145 cockpit

Photographed by Derek Pedley, for www.airteamimages.com

This edition distributed by Transair (UK) Ltd, Shoreham, England: 2008
Printed in Singapore by KHL Printing Co. Pte Ltd

Textbook Series

Book	Title	EASA Ref. No.	Subject
1	010 Air Law	010	
2	020 Aircraft General Knowledge 1	021 01	Airframes & Systems
		021 01 01-04	Fuselage, Wings & Stabilising Surfaces
		021 01 05	Landing Gear
		021 01 06	Flight Controls
		021 01 07	Hydraulics
		021 01 08-09	Air Systems & Air Conditioning
		021 01 10	Anti-icing & De-icing
		021 01 11	Fuel Systems
		021 04 00	Emergency Equipment
3	020 Aircraft General Knowledge 2	021 02	Electrics – Electronics
		021 02 01	Direct Current
		021 02 02	Alternating Current
		021 02 05	Basic Radio Propagation.
4	020 Aircraft General Knowledge 3	021 00	Powerplant
		021 03 01	Piston Engines
		021 03 02	Gas Turbines
5	020 Aircraft General Knowledge 4	022	Instrumentation
		022 01	Flight Instruments
		022 03	Warning & Recording
		022 02	Automatic Flight Control
		022 04	Power Plant & System Monitoring Instruments
6	030 Flight Performance & Planning 1	031	Mass & Balance
		032	Performance
7	030 Flight Performance & Planning 2	033	Flight Planning & Monitoring
8	040 Human Performance & Limitations	040	
9	050 Meteorology	050	
10	060 Navigation 1	061	General Navigation
11	060 Navigation 2	062	Radio Navigation
12	070 Operational Procedures	070	
13	080 Principles of Flight	080	
14	090 Communications	091	VFR Communications
		092	IFR Communications

Contents

FLIGHT INSTRUMENTS

1. CHARACTERISTICS AND GENERAL DEFINITIONS 1

2. PRESSURE HEADS. 19

3. AIR TEMPERATURE MEASUREMENT 29

4. THE AIRSPEED INDICATOR. 41

5. THE PRESSURE ALTIMETER. 53

6. THE VERTICAL SPEED INDICATOR 75

7. THE MACHMETER 85

8. TERRESTRIAL MAGNETISM 99

9. THE DIRECT INDICATING COMPASS 113

10. GYROSCOPES 133

11. DIRECTIONAL GYRO INDICATOR (DGI) 147

12. THE ARTIFICIAL HORIZON 163

13. THE TURN AND SLIP INDICATOR 179

14. THE TURN CO-ORDINATOR 189

15. AIRCRAFT MAGNETISM. 193

16. REMOTE INDICATING MAGNETIC COMPASS 205

17. INERTIAL NAVIGATION SYSTEM 223

18. INERTIAL REFERENCE SYSTEM 249

19. AIR DATA COMPUTER 257

20. RADIO ALTIMETER 265

21. FLIGHT MANAGEMENT SYSTEM 273

22. ELECTRONIC FLIGHT INFORMATION SYSTEM (EFIS). 283

23. HEAD-UP DISPLAY 309

24. BASIC COMPUTERS. 323

25. COMMUNICATIONS AND THE FUTURE AIR NAVIGATION SYSTEMS . . . 341

AUTOMATIC FLIGHT AND CONTROL SYSTEMS

26. FLIGHT DIRECTOR SYSTEMS 349

27. AUTOPILOT 367

28. AUTOLAND 395

29. AUTOTHROTTLE 405

30. YAW DAMPERS 417

31. CONTROL LAWS 437

32. REVISION QUESTIONS - AFCS 445

WARNING AND RECORDING SYSTEMS

33. FLIGHT WARNING SYSTEM.461
34. AERODYNAMIC WARNINGS469
35. GROUND PROXIMITY WARNING SYSTEM (GPWS).479
36. AIRBORNE COLLISION AND AVOIDANCE SYSTEM (ACAS)509
37. FLIGHT DATA RECORDER.527
38. COCKPIT VOICE RECORDER535

POWER PLANT & SYSTEMS MONITORING INSTRUMENTATION

39. ENGINE INSTRUMENTATION545
40. ELECTRONIC INSTRUMENTATION573

REVISION QUESTIONS

41. REVISION QUESTIONS.597

CHAPTER ONE

CHARACTERISTICS AND GENERAL DEFINITIONS

Contents

INTRODUCTION	3
MEASURING RANGE VERSUS ACCURACY	3
ERGONOMY	5
INSTRUMENT INDICATORS	10
ACCURACY AND RELIABILITY	13
SIGNAL TRANSMISSION	15

INTRODUCTION

Pilots receive information about the state of their aircraft and its speed, altitude, position and attitude through instruments and displays. These can vary from the simplest of dials and pointers to modern electronic displays (the so-called ‘glass cockpits’), depending on the vintage and the complexity of the aircraft, and a simple dial can seem very different in appearance and sophistication from a modern cathode ray tube or liquid crystal screen. However, certain problems of **range, resolution, accuracy and reliability** are general characteristics of all instrumentation systems.

MEASURING RANGE VERSUS ACCURACY

It is often necessary to show a large operating range, yet still indicate with accuracy over the whole range. For instance, an airliner might be limited to a maximum permitted airspeed of 350 knots, so perhaps the instrument would be designed to display up to, say, 380 or 400 knots. However, certain speeds are critical to flight safety and need to be read with extreme accuracy – ideally to the nearest knot. If we put the whole range on a single revolution of the instrument the division representing one knot will very small and will be difficult to read accurately.

Circular Scale (Linear).

A simple indicator showing the change of value of the parameter to be measured over a range of 0 to 30 units is shown in Figure 1.1 (Linear). The accuracy with which these values need to be measured will govern the spacing of the graduation.

Circular Scale (Non-Linear).

Some instruments are required to show changes of parameters more accurately at certain parts of the scale. The example in Figure 1.1 (Non-Linear) shows a rate of climb indicator where low rates of climb are more easily read than high rates. This is a **logarithmic** scale.

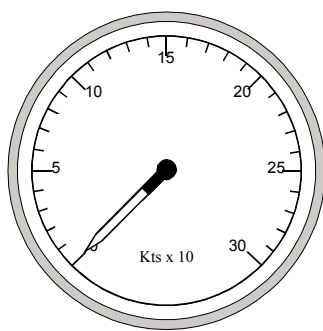

Linear

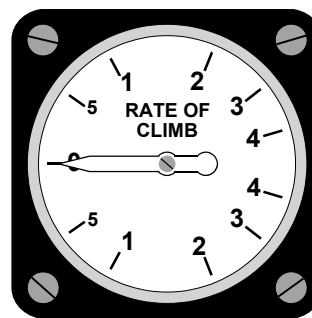

Non-Linear

Figure 1.1 Circular Scales

High Range Long Scale Displays.

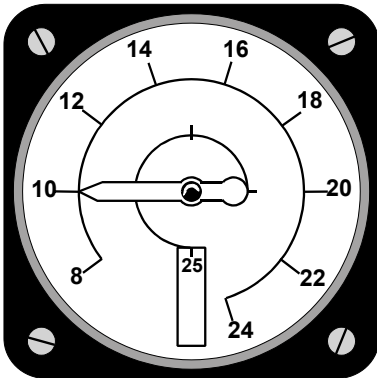

Figure 1.2
Single Pointer Air Speed Indicator

Where the instrument needs to show changes over a high range of values and these changes need to be read with a fair degree of accuracy, 360° of movement of the pointer may not be sufficient. The pointer may make more than one revolution to cover the required range, as on the **air speed indicator** shown in Figure 1.2, though this type of display may lead to some confusion.

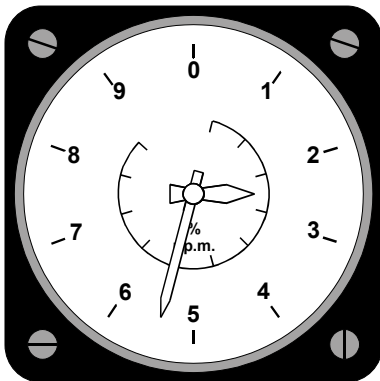

Figure 1.3
A Revolution Counter

A less confusing display uses two concentric pointers moving over two separate scales, as shown on the revolution counter.

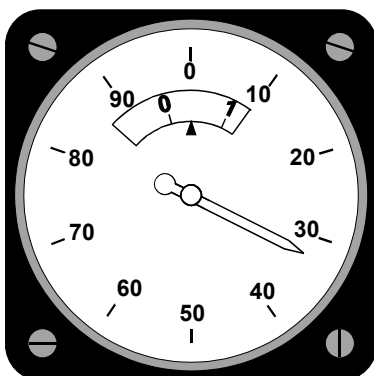

Figure 1.4
An Air Speed Indicator

Another solution is to have a pointer moving over a fixed scale (tens of knots) with a moving scale indicating larger units (hundreds of knots).



A further solution, shown in Figure 1.5, is to display information in a similar fashion to a clock, with pointers showing hours, minutes and seconds. This system is used on many altimeters. The long pointer will cover 1000 feet in one revolution, so each division of the scale represents 100 feet. The middle pointer will cover 10,000 feet per revolution, each division marking 1000 feet and the smallest pointer (sometimes in the form of a 'bug' on the outside of the scale) will cover 100,000 feet, each division representing 10,000 feet.

Figure 1.5
A Three Pointer Altimeter

ERGONOMY

Ergonomy (also known as **human engineering**) is defined as the science of relationships between people and machines. An ergonomic device interacts smoothly with peoples' bodies and actions. In an aviation context this can mean designing the shape and position of controls, levers and knobs so that are easily controlled and unlikely to lead to an incorrect selection. For instruments or instrument systems it means designing instruments that are unlikely to be misread and locating them in a layout that facilitates easy and correct interpretation of the information displayed. Standard layouts came to be adopted.

Location.

The 'flying' instruments which covered the handling of the aircraft were arranged in the layout of the 'basic six'. Other instruments tended to be scattered around the cockpit in positions most convenient to the designer and manufacturer, seldom to suit the needs of the pilot.

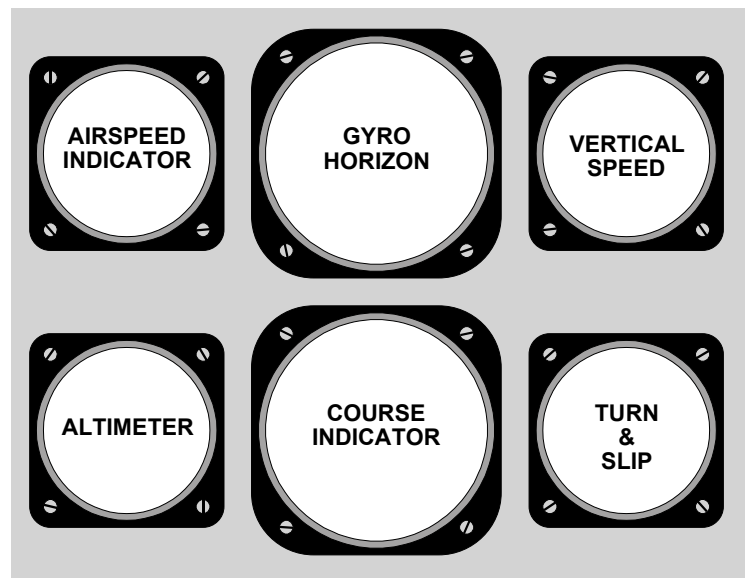

Figure 1.6 The 'Basic Six' Instrument Layout.

Since the introduction of the 'basic six' developments in aircraft instruments and operations led to the introduction of the 'basic T'.

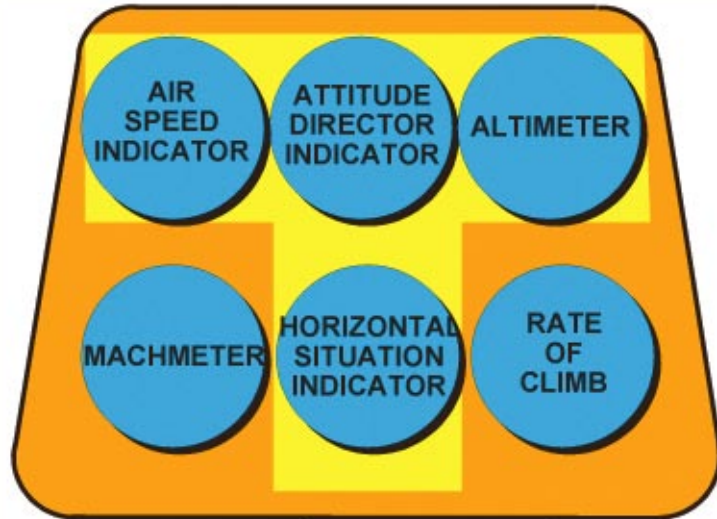

Figure 1.7 The 'Basic T' Instrument Layout.



Figure 1.8 The Basic Instrument Panel of a Piper PA 34 Seneca

Historically, instruments have been located on **instrument panels** (Figure 1.8), though this is now changing with modern electronic displays. Compare Figures 1.8 with the Boeing 737 layout below.

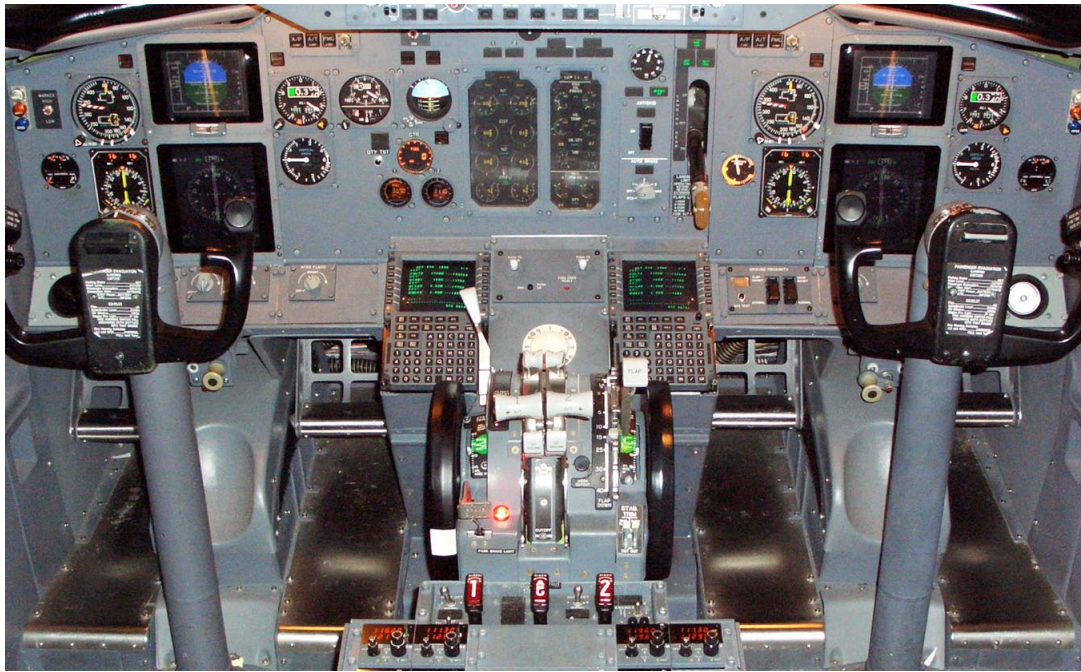

Figure 1.9 Boeing 737 Instrument Panel

With modern electronic systems, although the displays have to be on the flight deck where the crew can see and operate them, the computing units and power units are located remotely in some other part of the aircraft, usually in a separate compartment called the **Avionics Bay** or the **Electrics and Electronics (E&E) Bay**.

Readability

A readable instrument should be designed with an **eye reference point** in mind. This is the anticipated position that the pilot's eye will occupy when viewing the instrument under normal conditions. If the instrument has a design where there is a reference mark or index (on compasses, often called a **lubber-line**) with a scale behind it, it is important that the eye, the index and the scale are all in line. Otherwise, there is an error known as **parallax**, which is simply caused by viewing the instrument from slightly to one side instead of from the front. Direct reading (standby) compasses are particularly prone to parallax error, because there is usually only one of them to be shared by two pilots and in a side-by-side cockpit, it is often placed in the middle so that both pilots are viewing it from their respective sides and not from in front.

Presentations can be in **analogue** or **digital** form. Analogue is, typically, a pointer on a dial whereas digital is a row of numbers. Look at the 2 types of altimeter display at Figures 1.10 and 1.11.

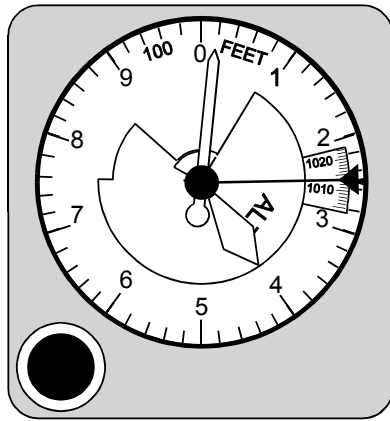

Figure 1.10
An analogue altimeter

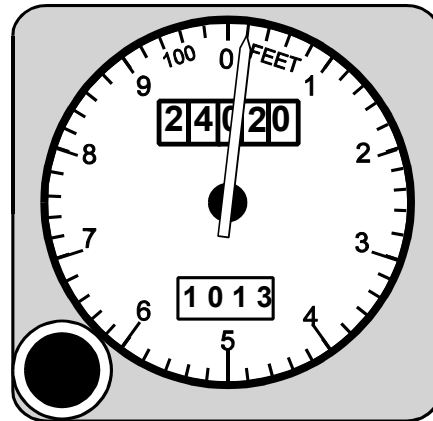
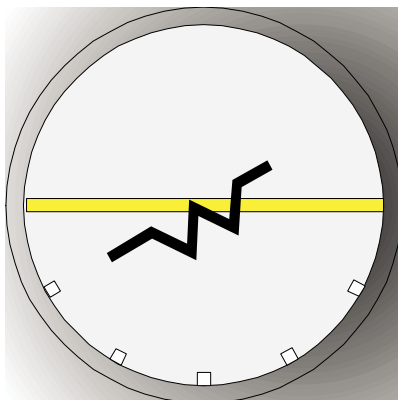

Figure 1.11
A digital altimeter

With the 3-pointer analogue system, the altitude information (24,020 feet) is harder to absorb at a single glance than with the digital display. The digital numbers are much easier to read. However, we note that one pointer still remains in the design of the mainly-digital presentation. This is because the human eye and brain cannot easily interpret **rate** information from moving numbers and, whilst the altimeter is primarily designed to show altitude, with a separate instrument (the vertical speed indicator) to show rate of change of altitude, nevertheless, pilots pick up a lot of secondary information about vertical rate from the **angular rate** of the altimeter pointer.

It is possible to characterise some displays, particularly those showing attitude, as **inside-out** or **outside-in**. This refers to the point of view of the observer. Attitude displays normally consist of an **aircraft symbol** and a **horizon symbol** (see Figure 1.12). The normal presentation is inside-out – in other words, the aircraft symbol stays fixed and the horizon rolls and moves up and down to keep it parallel with the real horizon. This is the view you would see from inside the aircraft (moving horizon).



Outside-in (Unusual)

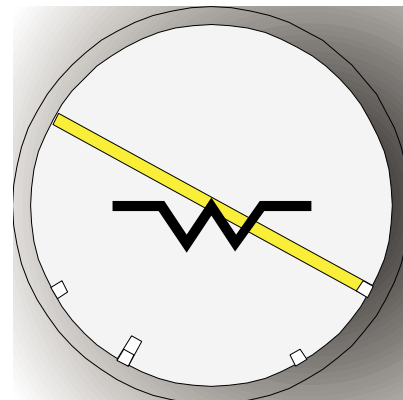

In-side out (Normal)

Figure 1.12 Attitude presentation

An outside-in presentation would maintain the horizon level and roll the aircraft symbol (moving aircraft). These are less common, but some exist. These tend to be preferred by inexperienced pilots, but experienced pilots prefer the moving-horizon type and more natural to use.

Coloured Arcs

A standardized system of colour coding for operating ranges for conventional non-electronic instrument is widely used. These are:

- Green:** Normal operating range
- Yellow or Amber:** Cautionary range
- Red:** Warning, or unsafe operating range

Figure 1.13 is an example of the gauges, fitted to a Piper Warrior, showing the colour coding.



Figure 1.13 Red, yellow and green operating ranges.

For more complex instruments, usually electronic displays, JAR-25 sets out the following colour standardization.

- White:** Present status
- Blue:** Temporary situation
- Green:** Normal operating range
- Yellow or Amber:** Cautionary range
- Red:** Warning, or unsafe operating range



Figure 1.14 Electronic Primary Flight Display - Boeing 737

INSTRUMENT INDICATORS

Instrument **indicators** can be **mechanical**, **electrical** or, in more modern systems, **electronic**.

Mechanical. Mechanical systems are those based on **gears**, **levers** and **connecting rods** which provide the indication by moving a **pointer** on a **dial**. Most traditional instruments such as the altimeter or airspeed indicator on a typical light training aircraft are of this type. Look at the analogue altimeter at Figure 1.10.

Electrical. Electrical indicators can be of the moving-coil type, the ratiometer type or be synchro or servo driven. In both the **moving-coil** and **ratiometer** the signal being transmitted is in the form of an electrical current and the indicator is actually a voltmeter, but instead of being calibrated in volts the scale shows the quantity being measured. An example is an air temperature gauge, where the sensor actually measures temperature by measuring changing electrical resistance, then passes the information as a voltage. The meter is then deflected by an amount proportional to the voltage, but the scale (which is really measuring volts) is calibrated in degrees Celsius. Both types operate on the principle of passing a DC voltage through a coil, thereby turning it into an electromagnet. The coil is situated in a magnetic field and so when it becomes an electromagnet it is magnetically deflected in a turning motion.

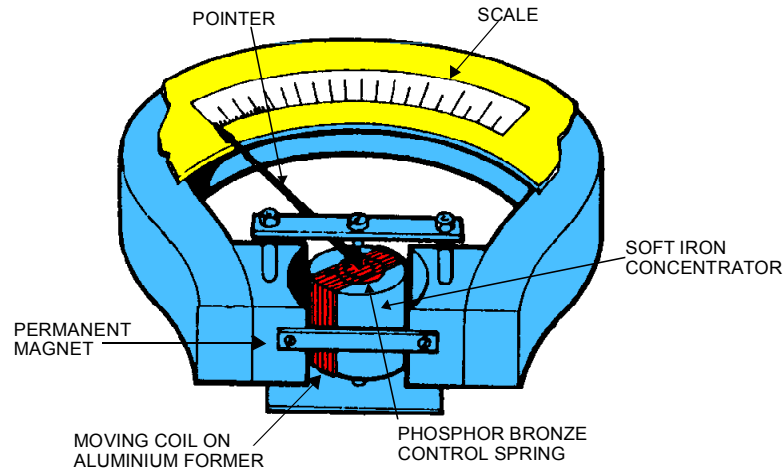

Figure 1.15 Moving Coil Meter

Synchro and **servodriven** indicators operate as described in the section on signal transmission. The indicator dial is the receiver element of a torque synchro transmitter (selsyn unit) or the servo driver of a synchro-servo system. These types of indicator are particularly good for displaying angular information (compass heading, or radar scanner direction)

Electronic. The most popular electronic displays are 7-segment displays, 5 x 7 displays, cathode ray tubes and liquid crystal displays.

Segmented Light Emitting Diode (LED) displays. The most popular form of display is the seven-segmented display shown. Each of the seven segments is an individual light-emitting diode. These glow (usually red or green) and can be seen in the dark or in low light conditions. By illuminating a combination of the segments it is possible to illuminate the decimal digits. A limited range of alphabetical characters can be obtained, as shown at Figure 1.16 below.

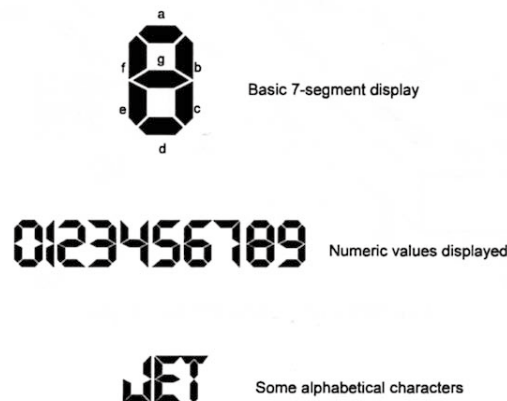

Figure 1.16 Seven-segment LED display

Dot array LED displays. Using a group of individual LEDs in a rectangular dot array or dot matrix, it is possible to display the full range of alphanumeric characters together with a wide range of mathematical characters. One of the most popular types is the 5 x 7 dot matrix display, which uses an array of 35 LEDs arranged in 5 columns and 7 rows.

Alternative dot arrays, such as a 4 x 7 display, are available but have less versatility than the 5 x 7 display.

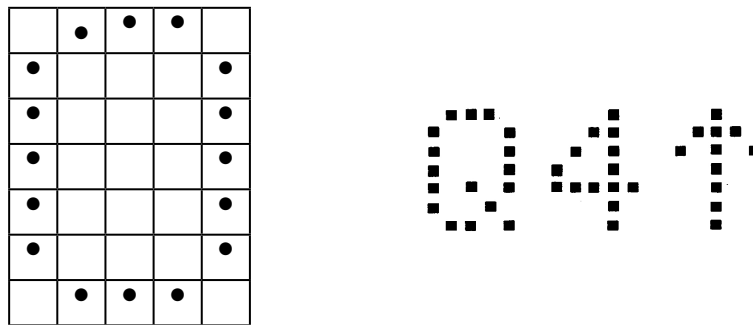

Figure 1.17 5 x 7 LED Dot Arrays

Cathode Ray Tube (CRT) Displays. A CRT is a vacuum valve in which a beam of electrons is made to produce a spot of light on a screen at one end. The position on the screen and the brightness of the spot can be changed almost instantaneously. The basic construction of a CRT is shown in Figure 1.18. The beam of electrons produced by the electron gun is focused onto the fluorescent screen and maybe deflected to any position on the screen by the deflection device. If the spot of light is made to travel across the same path on the screen many times a second, a visible trace will appear.

CRT's are classified into three types, depending on which method is used for focusing and beam deflection. These are:

- Electrostatic CRT, which has electrostatic focusing and deflection.
- Electromagnetic CRT, which has electromagnetic focusing and deflection.
- Combined CRT, which has electrostatic focusing and electromagnetic deflection

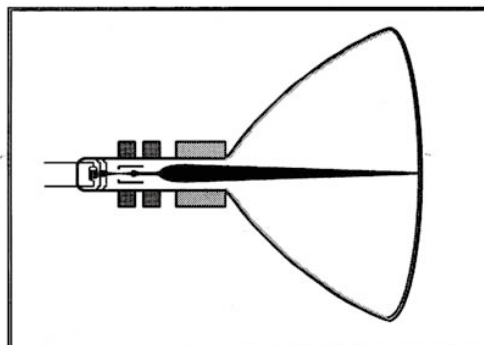

Figure 1.18 Cathode Ray Tube

Liquid Crystal Displays (LCD). Liquid crystals are materials which are liquid at room temperature and have a molecular structure which is thread-like in nature. The liquid crystals used in electronic displays are known as nematic liquid crystals. The application of an electrical voltage across a very thin film (typically 10 micrometre thick) of liquid crystal causes the optical properties of the crystals to alter. The LCD itself does not produce any illumination, and depends entirely on illumination falling on it from an external source for its visual effect.

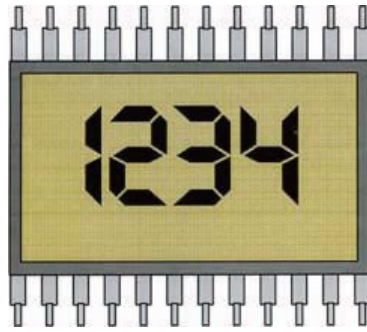

Figure 1.19 Liquid Crystal Display

ACCURACY AND RELIABILITY

No instrument can be perfectly accurate because of basic characteristics of design and manufacturing. Accuracy will vary with the design and sophistication of the instrument, which will be very dependent on the cost. Over-engineering adds expense, and most instruments are designed to be as accurate as is necessary for their purpose but at as low a cost as possible.

Error is expressed as a **tolerance** which is the limit within which the instrument has been designed to be accurate. For instance, an altimeter may be quoted as having a specified accuracy of ± 30 feet at sea level. A tolerance can be quoted either as an **absolute error** or a **relative error**.

An **absolute error** gives the range of possible values in terms of the unit of measurement. For instance, an altitude measurement might be quoted as having a tolerance (absolute error) of 40000 feet ± 100 feet.

However, absolute errors do not give an indication of the importance of the error. It is therefore preferable sometimes to give a relative error. **Relative Error** is defined as follows:

$$\text{Relative Error} = \frac{\text{Absolute Error}}{\text{Measured Value}}$$

For instance, if a Radio Altimeter is quoted as having a possible error as 1000 feet ± 30 feet the relative error is ± 0.03 . However, in aviation it is more normal to quote it as a percentage, ie as $\pm 3\%$ of the measured value

Errors can also be classified as **systematic** or **random**. **Systematic** errors are those caused by errors in the measurement system or by incorrect procedures. For instance, a Radio Altimeter has a correction factor built into it to allow for the difference between the height of the antennae (usually in the under surface of the wings) and the height of the datum which is required to be measured (the height of the lower wheel bogey when the oleo legs are not compressed by weight – ie, the point of first impact with the ground). If this height difference is set up incorrectly, then the measurement made will always be in error by a fixed amount – the systematic error – in addition to any random errors.

Random errors are those which can vary. The mechanical wander rate of gyroscope is a good example. Some gyro wander is caused by imperfections in manufacture – bearing friction and unbalanced mass, for instance. This will cause the gyro to wander away from its fixed orientation but the direction and rate of the error will be unpredictable.

Instrument error is the generic term for these errors. It is defined as the **combined accuracy and precision of a measuring instrument**, or the **difference between the actual value and the value indicated by the instrument**. Instrument error is that error which is attributable to instrument only, not the errors in the inputs into it. Therefore an airspeed indicator, for instance, may be in error because the pressure entering into it has been adversely affected by the turbulence round the sensor probe, but that is not instrument error. Instrument error is that part which occurs when the **right input goes in but the instrument indicates it incorrectly**. Instrument error can either be designed out of a system by opting to pay for a better quality instrument or it can be allowed for by calibrating the instrument against a test set and correcting the instrument reading in subsequent use.

We may also be interested in assessing the **reliability** of an instrument, particularly if it is complex, with many places for failure to occur, such as an electronic display. Reliability is defined as the probability of an item performing as specified under stated conditions for a stated period of time. The most common measures of reliability are:

Failure Rate: Failure Rate is defined as the number of **failures per unit time** (usually hours of use rather than calendar time). For this definition and the next one to work, we need to agree on what constitutes a failure.

Mean Time Between Failure (MTBF). Mean Time Between Failure is defined as the **mean value of the length of time between consecutive failures** for a given item. It is computed as follows:

$$\text{MTBF} = \frac{\text{Total Cumulative Observed Time}}{\text{Total Number of Failures}}$$

Mean time Between Outages (MTBO). The difference between a ‘failure’ and an ‘outage’ is that failure refers to a single equipment whereas ‘outage’ refers to a system – i.e. to linked items. An ‘outage’ means that the system as a whole, for whatever reason, is not performing as specified. The components of the system and the specified level of performance have to be defined and agreed before a definition of an outage becomes meaningful. Whether MTBO is greater or less than MTBF will be different depending on the flow logic of the system. The 2 items may duplicate a task and the system can work with just one of them (a **redundant** system) or the system may need both items to work at all. In the first case a single failure will not result in an outage and so there will be fewer outages than failures. In the second case, the result of either Item A or Item B failing will result in an outage, so there will be more outages than failures.

SIGNAL TRANSMISSION

Signals are transmitted from the sensor where they are measured to the instrument where they are displayed by a variety of signals transmission techniques:

Mechanical. Early systems had mechanical feedback to an indicator on the flight deck to show the position of a valve, flap or control surface. However, these systems have been largely replaced by remote transmission systems on modern aircraft.

Pneumatic. Pneumatic pressure is air pressure conveyed in a tube or pipe. Airspeed and altitude instruments use pneumatic transmission from the pitot or static probe/vent to the instrument.

Hydraulic. Hydraulic pressure is liquid pressure conveyed in a tube or pipe. Older versions of oil pressure gauges receive direct oil pressure down a pipe into the back of the indicator.

Electric or Electronic. Older systems used DC transmission, known as desynn indicators. Modern aircraft use an AC transmission system, known as **synchro** transmission. A **torque synchro system** transmits angular position and is suitable for indicators whilst a **synchro-servo system** can be used to drive a heavy load to a particular angular position. Both systems use the principle of the **selsyn**, which uses components called **stators** and **rotors**.

The A.C. systems are collectively called **Synchros**, and work on the principle of a variable transformer. The A.C. voltage used is 26 volt. In the illustration below (Figure 1.20), as the input shaft is rotated the induce signal in the secondary winding can be varied in two ways.

- The magnitude of the induced signal will vary in direct relationship to the angle between the primary and secondary windings.
- The phasing of the induced signal will vary twice for one complete rotation of the primary winding.

We have one **rotor** coil (primary), and three **stator** coils to produce the output (secondaries).

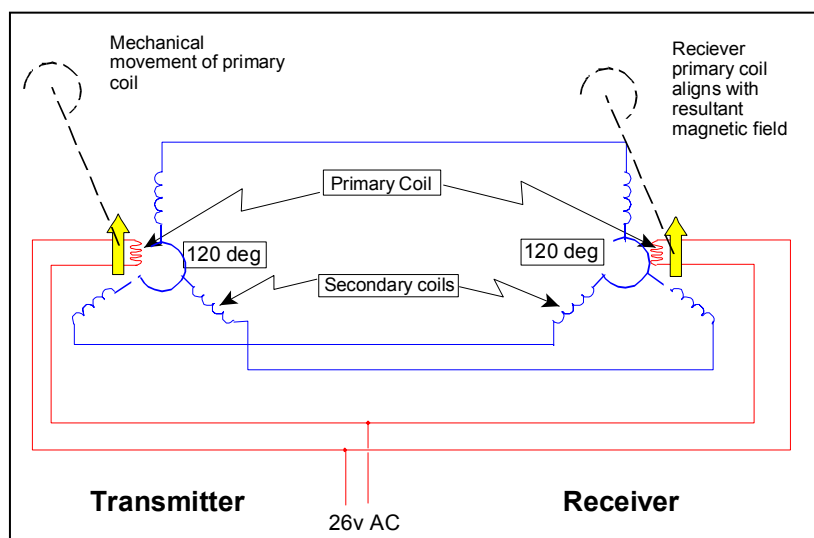

Figure 1.20 AC Synchro System

The Torque Synchro System. In the torque synchro system, the transmitter consist of three secondary coils positioned at 120° to each other and a fourth primary coil placed within them. An A.C. current is passed through the primary coil which produces an alternating magnetic field. This alternating magnetic field causes an EMF to be induced in the three secondary coils. The value of the EMF induced in any one of the secondary coil is dependant upon its relative position to the primary coil.

The receiver also consists of three secondary coils positioned at 120° to each other and a fourth primary coil placed within them. The receiver secondary coils are in series with the secondary coils of the transmitter. This closed circuit causes a current to flow through the coils.

The value of the current is proportional to the value of the induced EMF in the associated transmitter secondary coil. The three magnetic fields produced by the secondary coils combine to produce a resultant field. The receiver primary coil is in series with the transmitter primary coil. This causes the receiver primary coil to align itself in the resultant magnetic field produced by the receiver secondary coils and thus remotely reproduce the position of the input.

The Synchro-Servo System. The synchro-servo system is similar to the torque synchro in that the stators are connected so that the direction of field in the transmitter stators will be reproduced in the receiver stators. However, the sole role of the transmitter rotor is simply to produce the transmitter stator field. It is not connected to the receiver rotor. The transmitter stator field is reproduced in the receiver stator. The receiver rotor detects the receiver stator field and if the rotor coil is not at exactly right angles to the stator field, some signal is induced in the receiver rotor. This is passed to an amplifier, which turns a load, which is connected to the receiver rotor. The rotor will continue to turn until no signal is induced in itself. This will occur when it is at 90° to the field, and therefore, at precisely 90° to the transmitter rotor. This means that the receiver shaft is now 90° removed from the transmitter shaft, but this is no problem, since the indicator card on the receiver will also be mounted 90° out to make it read the same as the transmitter angle.

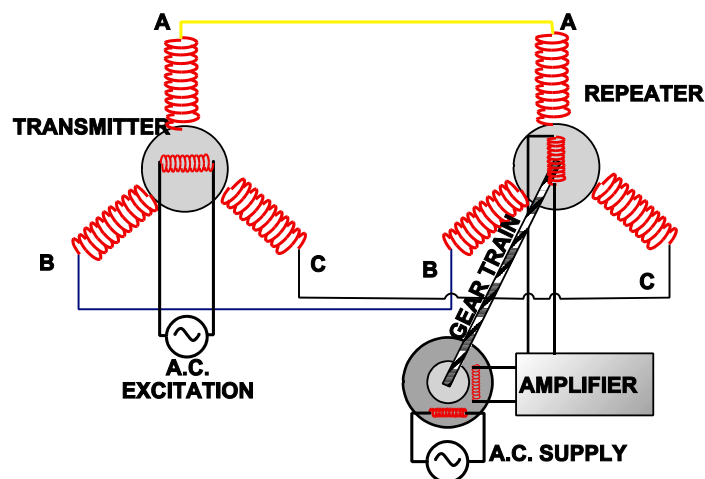

Figure 1.21 Synchro-Servo System

The advantage of the synchro-servo system over the torque synchro system is that it can be used to drive a heavy load. It is, for example, used in Gyro-Magnetic compass to align a gyro with a magnetically detected signal. A simple torque synchro would not have the power.

Digital. Digital systems use data buses to convey large amounts of information without dedicated one-to-one wires. For compatibility, these must be designed to common specifications. Aeronautical Radio Incorporated (ARINC) is a corporation made up of scheduled airlines, transport companies, aircraft manufacturers and foreign flag airlines. One primary activity of ARINC is to produce specifications and reports for the purpose of:

Indicating to manufacturers the group opinion concerning requirements of new equipments

Channeling new equipments designs in a direction which will result in maximum standardisation

Figure 1.15 shows the integrated avionics fitted to a Boeing 737/300. All the individual systems adhere to ARINC specifications. The Autopilot/Flight Director is manufactured by Sperry, the FMS and Autothrottle by Smiths UK and the IRS by Honeywell. All the four systems are compatible with each other and communicate via the data bus system.

Data Buses. The availability of reliable digital semiconductor technology has enabled the inter-communication task between different equipments to be significantly improved. Previously, large amounts of aircraft wiring were required to connect each signal with all the other equipments. As systems became more complex and more integrated so this problem was aggravated. Digital data transmission techniques use links which send streams of digital data between equipments. These data links may only comprise two or four wires and therefore the inter-connecting wiring is very much reduced. Recognition of the advantages offered by digital data transmissions has led to common standards being agreed. Examples of these standards are ARINC 429 and ARINC 629.

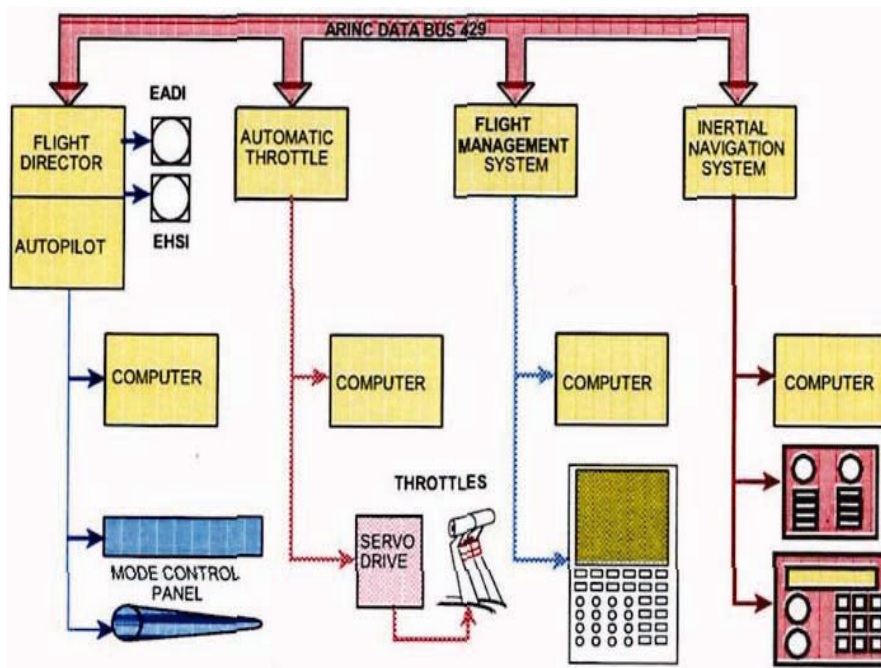

Control Surface

Display and Control Units

Figure 1.22 Boeing 747-300 Integrated Flight Control System

CHAPTER TWO
PRESSURE HEADS

Contents

INTRODUCTION 21

PITOT/STATIC HEADS 21

POSITION ERROR 22

MANOEUVRE-INDUCED ERROR 23

EMERGENCY STATIC SOURCE 24

ADVANTAGES OF THE STATIC VENT. 24

PRE FLIGHT CHECKS OF THE PITOT/STATIC SYSTEM 24

QUESTIONS 25

ANSWERS 28

INTRODUCTION

An aircraft at rest on the ground, in still air, is subject to normal atmospheric pressure which bears equally on all parts of the aircraft. This ambient pressure is known as **Static** pressure. An aircraft in flight, while still subject to the static pressure at its height, experiences an additional pressure on the leading edges due to the resistance of the air to the aircraft's movement. This additional pressure is **Dynamic** pressure, and its value depends on the speed of the aircraft through the air and on the density of the air. The leading edges, therefore, encounter a total pressure consisting of static pressure plus dynamic pressure. This total pressure is known as **Pitot** pressure.

Two of the pressure-dependent flight instruments, the altimeter and vertical speed indicator, operate solely on static pressure, whereas the airspeed indicator and machmeter utilise both static and pitot pressures.

Inside an aircraft, pressure and temperature are seldom the same as outside the aircraft so pitot and static pressures must be sensed by devices mounted on the outside of the aircraft.

PITOT/STATIC HEADS

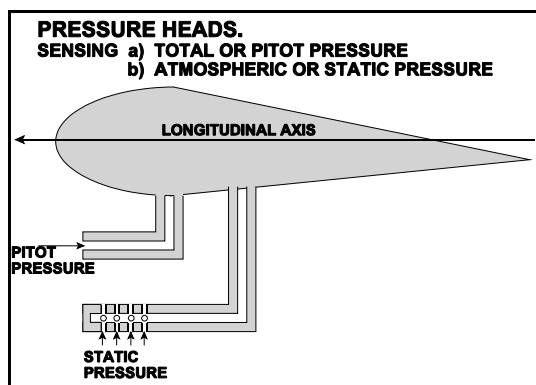

An open-ended tube parallel to the longitudinal axis of the aircraft is used to sense the total pressure (static plus dynamic). This device is a "pitot tube" mounted in a "pitot head".

The open end of the tube faces into the moving airstream, the other end leading to the airspeed capsules in the ASI and **Machmeter**.

Figure 2.1 Pitot and Static Heads

The moving airstream is brought to rest in the tube, so generating the extra (dynamic) pressure, which together with the static pressure already in the tube provides the required total (pitot) pressure.

A "static head" consists of a tube with its forward end sealed but with holes or slots cut in the sides. These slots do not face into the airflow and therefore they sense only the static pressure. This pressure supplies the static line to the pressure instruments. A pressure sensing system consisting of separate pitot and static heads is shown in Figure 2.1.

The static and pitot sources may be combined in one pressure head, the static tube surrounding the pitot tube, with separate pressure lines leading to the pressure instruments. An electric anti-icing heater coil is usually incorporated. Figure 2.2 illustrates an example of this type. Any errors due to the heating effect may be reduced by design, and calibration.

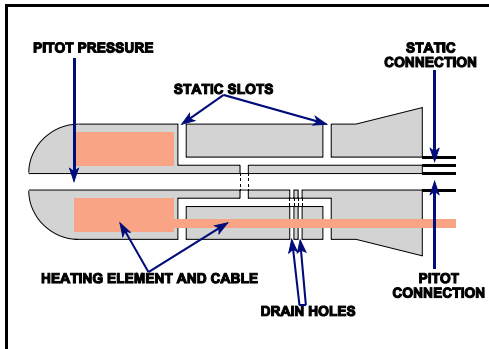

Figure 2.2
A Combined Pitot/Static Pressure Head

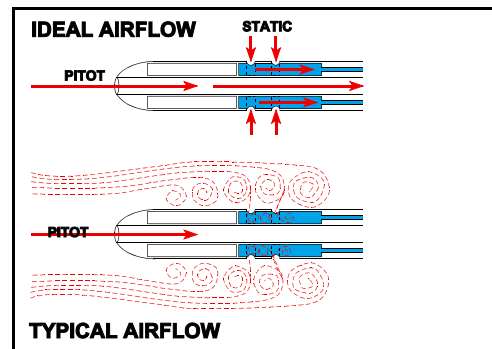

Figure 2.3
Turbulence Affecting a Pressure Head

POSITION ERROR

It will be appreciated that if, due to turbulent airflow in the region of the pitot/static heads, the pressures sensed are not truly representative of the pitot and static pressures, the pressure-dependent instruments will not read correctly. The error involved is called **Position Error** (or alternatively 'pressure' error). At large angles of attack the pressure head is inclined at an angle to the airstream so that position error is usually biggest at the lower airspeeds. Flight manuals may list different values of position error for different flap settings.

Position error depends mainly on the positioning of the pressure head, the airspeed, and the aircraft attitude. Turbulence produced in the airstream by the pressure head itself affects the value of static pressure sensed rather than the pitot pressure. This is shown diagrammatically in Figure 2.3.

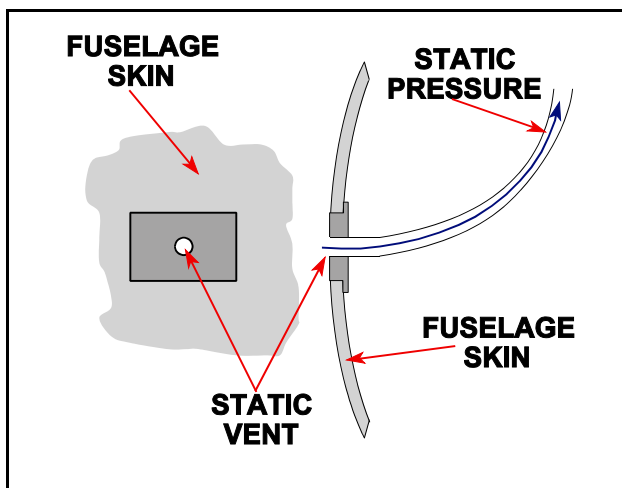

Figure 2.4 A Static Vent

Approximately 95% of the position error associated with a combined pressure head is produced by turbulence about the static head.

Because of this, the **Static Vent**, was introduced as a source of static pressure instead of the static head, pitot pressure then being sensed by a simple pitot head. About 90% of the combined pressure head position error is eliminated by use of a separate pitot head and static vent as shown in Figure 2.4.

There is usually some place on the airframe, usually on the side of the fuselage, where true (or nearly true) static pressure obtains over the whole speed range of the aircraft.

A flat metal plate is fitted at this position, the static line from the pressure instruments terminating at a small circular hole - the static vent - in this plate. A similar vent may be positioned on the opposite side of the fuselage and the two interconnected for transmission of static pressure to the instruments so that errors produced by yawing are largely eliminated.

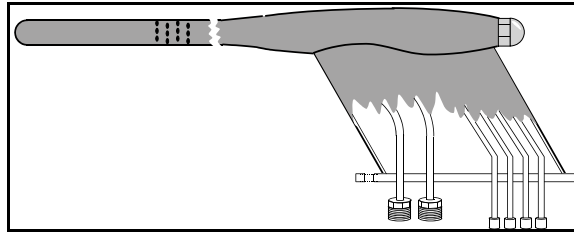

Figure 2.5 A High Speed Pitot/Static Probe

The shock waves associated with flight at high mach numbers can produce significant errors in pressure sensed by a static vent. Modern high speed aircraft may accordingly be fitted with a more sophisticated combined pitot/static pressure head in order to keep position error within acceptable limits. The choice of location for a probe, or vent, is dependant upon the aerodynamics of the aircraft. Typical locations are: ahead of a wing tip, under a wing, ahead of the vertical stabiliser tip, at the side of the fuselage nose section, and ahead of the fuselage nose section.

MANOEUVRE-INDUCED ERROR

Manoeuvre-induced errors are caused by short-term fluctuations of pressure at the static vents and delays in the associated pipelines transmitting pressure changes to the instruments.

Even servo-altimeters and Air Data Computer systems suffer from this type of error as they utilise the same static vents as the simple pressure instruments. Change in angle of attack, and turbulence due to lowering (or raising) flaps and landing gear are the prime causes of the error-producing changes in airflow over the static vents.

Most commonly, manoeuvre-induced error appears as a marked lag in pressure instrument indications.

The errors are usually more significant during changes of pitch attitude than during yawing or rolling movements so that the worst effects are at the start of the climb or descent and on levelling out.

Overshooting and flight in rough air are particularly vulnerable.

The errors are unpredictable both in size and in sense so that pressure instruments cannot be relied upon to indicate accurate instantaneous values or accurate rates of change.

This particularly applies to vertical speed indicators. In-flight manoeuvres should therefore be carried out using gyroscopic instruments as the primary reference. A manoeuvre-induced error may be present for some time after movement of the control surfaces has ceased, values of three seconds at low altitude increasing to 10 seconds at 30,000 feet (longer for VSIs) being quite common.

EMERGENCY STATIC SOURCE

An emergency static source is normally provided in the event of the static head/vents becoming blocked.

The emergency static source may be to the outside of the aircraft or from inside the cabin (in unpressurised aircraft only).

On those aircraft which sense emergency static pressure from outside the hull of the aircraft, the source will be **less accurate** than the primary (blocked. static vent/head, since that would have been in the optimum position.

When an emergency static source is fed from within the cabin, the static pressure sensed is likely to be **lower** than ambient due to aerodynamic suction.

Note: When alternate (standby) pressure systems are used, correction values for the instruments concerned may be found in the Operating Data Manual for the aircraft.

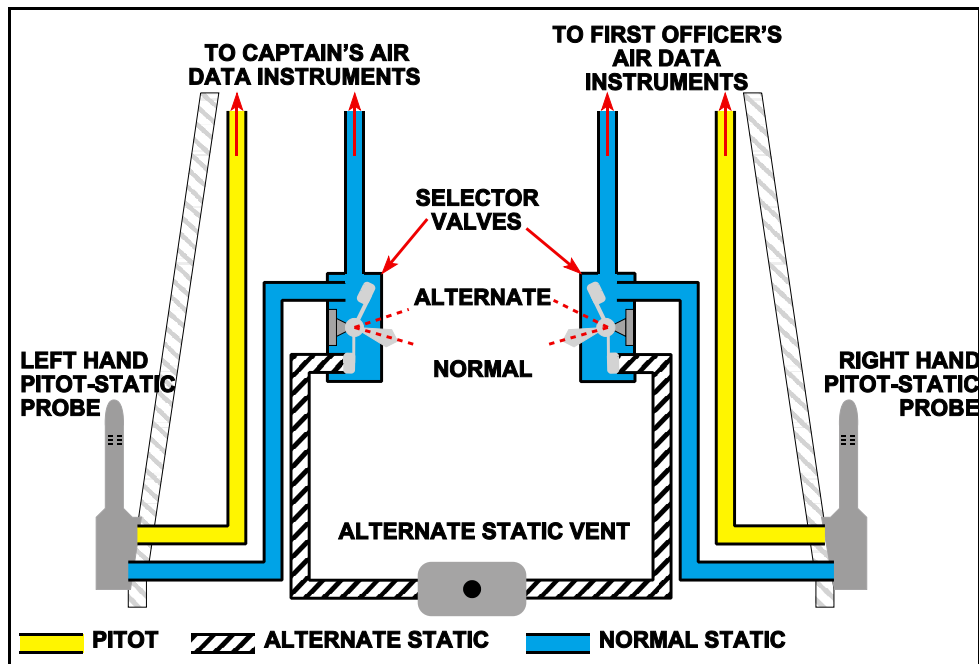

Figure 2.6 Emergency Static Source

ADVANTAGES OF THE STATIC VENT

- The airflow in the region of the vents is less turbulent and the static pressure measured is more accurate.
- Errors produced when side slipping or yawing are reduced.
- Duplication of vents either side of fuselage reduces blockage errors.

PRE FLIGHT CHECKS OF THE PITOT/STATIC SYSTEM

- All covers and plugs removed and stowed.
- All tubes, holes, slots free of obstructions.
- Pitot head heater operating.

QUESTIONS

1. A pitot head is used to measure:
 - a. dynamic minus static pressure.
 - b. static plus dynamic pressure.
 - c. static pressure.
 - d. dynamic pressure.
2. A static vent is used to measure:
 - a. dynamic pressure minus pitot excess.
 - b. dynamic pressure plus pitot excess.
 - c. atmospheric pressure.
 - d. pitot excess pressure.
3. A pressure head is subject to the following errors:
 - a. position, manoeuvre induced, temperature.
 - b. position, manoeuvre induced.
 - c. position, manoeuvre induced, density.
 - d. position, manoeuvre induced, instrument.
4. Turbulent flow around a pressure head will cause:
 - a. density error.
 - b. 95% increase in manoeuvre induced error.
 - c. an increase in the dynamic pressure.
 - d. 95% of pressure error.
5. Manoeuvre induced error:
 - a. is caused by transient pressure changes at static vents.
 - b. is likely to be greatest when yawing after engine failure.
 - c. is combined with instrument and position error on a correction card.
 - d. lasts for only a short time at high altitude.
6. Position error:
 - a. may be reduced by the fitting of static vents.
 - b. will usually decrease with an increase in altitude.
 - c. will depend solely on the attitude of the aircraft.
 - d. will usually decrease as the aircraft approaches the speed of sound.
7. Pressure heads supply data to the following instruments:
 - a. air data computers, compasses, altimeters, and ASI's.
 - b. standby instruments only, when air data computers fitted.
 - c. altimeters, ASI's, VSI's, machmeters, air data computers.
 - d. all the above plus air driven gyros.

8. Static vents are usually fitted to both sides of the aircraft fuselage. This will:
 - a. reduce the position error.
 - b. balance out errors caused by side slipping or yawing.
 - c. require a calibration card for each static vent.
 - d. enable a greater number of instruments to be fitted.

9. Which of the following instruments require inputs of both pitot and static pressure:
 - a. airspeed indicator, machmeter and vertical speed indicator.
 - b. airspeed indicator, vertical speed indicator, altimeter.
 - c. airspeed indicator only.
 - d. airspeed indicator and machmeter.

10. Where an alternate static source is fitted, use of this source usually leads to:
 - a. a temporary increase in lag error.
 - b. a lower pressure error than with normal sources.
 - c. an increase in position error.
 - d. no change in position error.

ANSWERS

- | | | | |
|---|---|----|---|
| 1 | B | 6 | A |
| 2 | C | 7 | C |
| 3 | D | 8 | B |
| 4 | D | 9 | D |
| 5 | A | 10 | C |

CHAPTER THREE

AIR TEMPERATURE MEASUREMENT

Contents

INTRODUCTION	31
THE EFFECT OF COMPRESSIBILITY	31
AIR TEMPERATURE THERMOMETERS	32
TOTAL AIR TEMPERATURE PROBE	33
ERRORS	35
BOEING 737 TEMPERATURE CORRECTIONS.	37
QUESTIONS	38
ANSWERS	40

INTRODUCTION

The measurement of air temperature is important to a pilot, not just to establish the likelihood of engine or airframe icing, but also in connection with many other aspects of aircraft performance, and flight planning. Increasing air traffic, higher operating costs, and greater performance demands have made precision air data measurements necessary for safety, economy and maximum performance. Thus, accurate and reliable air temperature measurement is essential to the safe and efficient operation of the aircraft.

THE EFFECT OF COMPRESSIBILITY

The measurement of the air temperature outside the aircraft appears a simple task, a thermometer which protrudes into the air stream should apparently be sufficient to do the job. However this is not the case, because as aircraft speed increases, the air close up to the aircraft becomes compressed. Due to this compression the air becomes heated. This means that the temperature sensed will too warm and not representative of the actual air temperature outside of the aircraft.

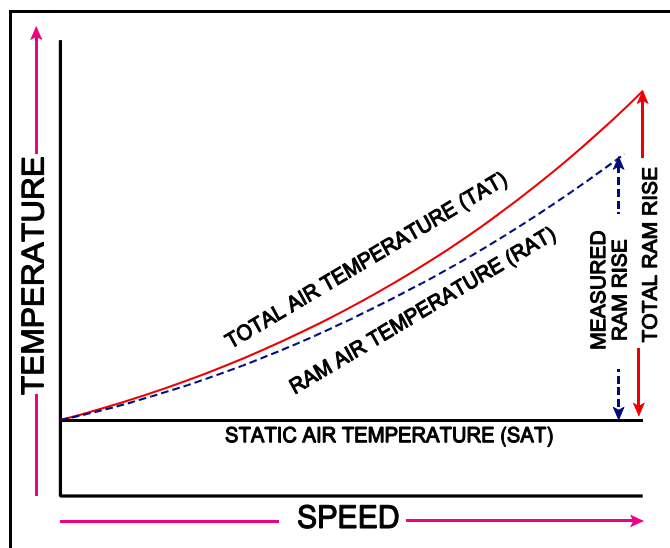

Figure 3.1 Temperature Relationships in Level Flight

Static Air Temperature (SAT) is the temperature of the undisturbed air through which the aircraft is about to fly.

Total Air Temperature (TAT) is the maximum temperature attainable by the air when brought to rest, adiabatically.

The increase of air temperature at higher speeds as a result of the adiabatic compression of the air is known as the “**Ram Rise**”.

The percentage of the “**Ram Rise**” sensed, and recovered, by a TAT probe is termed the Recovery Factor (K_r).

Thus a TAT probe having a factor of 0.90 would measure SAT plus 90% of the ram rise. A recovery factor of 1.0 would produce a reading of SAT plus 100% ram rise = TAT. Modern air temperature probes have recovery factors approaching 1.0.

AIR TEMPERATURE THERMOMETERS

Air Temperature Thermometers may be divided into two basic types:

Direct Reading

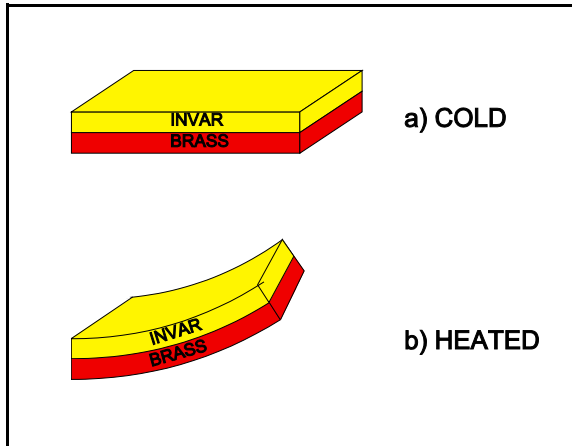

Figure 3.2 A Bi-Metallic Strip

A commonly used direct reading thermometer used in low speed aircraft uses a bimetallic strip consisting of two metals, such as Invar and Brass, bonded together as shown in Figure 3.2 a).

When this strip is heated, the brass, having a higher coefficient of expansion than the Invar, will expand much more than the Invar, with the result that the strip will bend as shown in Figure 3.2b).

How much the strip bends depends on the temperature rise to which the strip is subjected, and is therefore a measure of the temperature.

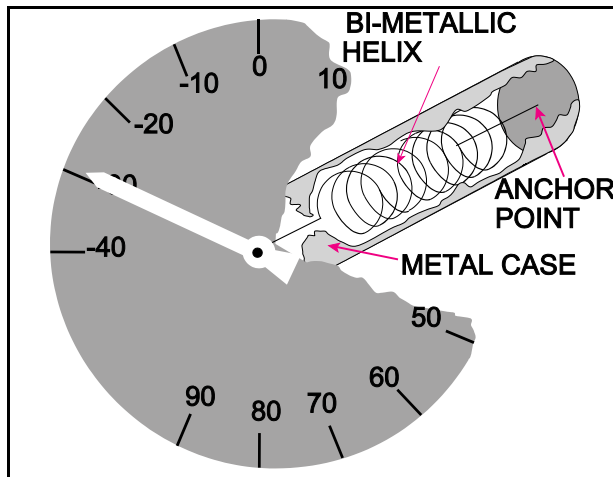

Figure 3.3 A Bi-Metallic Helix Thermometer

The principle of the bi-metallic strip is used to provide a direct indication of temperature. If the bi-metallic strip is wound into a helix (coil) then any temperature change will cause the helix to rotate.

A thermometer using this principle is shown in Figure 3.3.

The thermometer is mounted on the windscreen or fuselage, with the tube protruding into the air stream, and the dial is made visible to the pilot.



Figure 3.4 A Direct Indicating Thermometer

Remote Reading

The probe element forms one part of a resistance bridge circuit. As the temperature changes the resistance of the sensing element changes, and the bridge becomes unbalanced causing current to flow through the moving coil of the indicator. This change in resistance can then be calibrated to display temperature.

TOTAL AIR TEMPERATURE PROBE

The layout of a TAT probe in very common use is shown below.

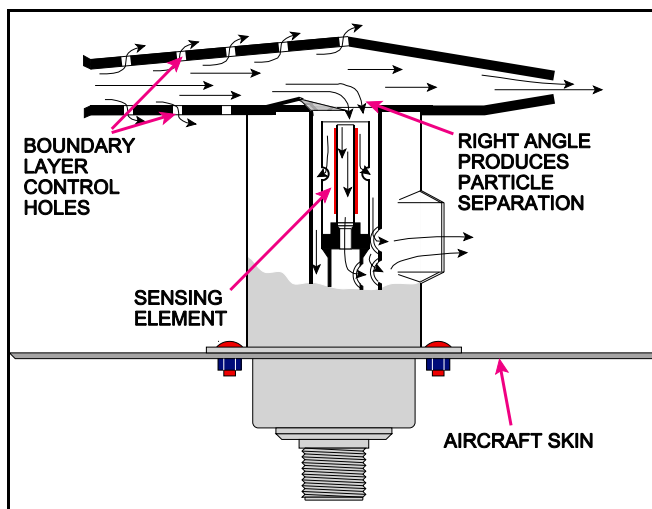

The probe is in the form of a small strut and air intake made of nickel-plated beryllium copper which provides good thermal conductivity and strength. It is secured at a pre-determined location in the front fuselage section of an aircraft outside of any boundary layer.

Figure 3.5
A Total Air Temperature Probe

In flight, the air flows through the probe in the manner indicated; separation of any water particles from the air is effected by the airflow being caused to turn through a right angle before passing round the sensing element.

The bleed holes in the intake casing permit boundary layer air to be drawn off under the influence of the higher pressure that is created within the intake and casing of the probe.

A pure platinum wire resistance-type sensing element is used. The probe has an almost negligible time-lag, and a high recovery factor of approximately 1.00.

A heating element is mounted integral with the probe to prevent the formation of ice, and is of the self-compensating type in that as the temperature rises so does the element's resistance rise, thereby reducing the heater current.

The heater dissipates a nominal 260 Watts under in-flight icing conditions, and can have an effect on indicated air temperature readings. The errors involved, however, are small, some typical values obtained experimentally being 0.9°C at 0.1 Mach, decreasing to 0.15°C at Mach 1.0.

In order to measure air temperature on the ground an air to air ejector (aspirator) may be fitted to the probe. Engine bleed air creates a negative differential pressure within the casing so that outside air is drawn through it at a rate sufficient to provide a reliable indication of temperature.

This device is used with turbine engine take off setting and auto throttle systems; it eliminates temperature soaking inaccuracies caused by bright sunshine heating the probe, or hot ramp heat radiation.



Figure 3.6 A TAT Probe Fitted to a Boeing 737

ERRORS

Aircraft thermometers used for the measurement of air temperature are subject to the following errors:

- Instrument errors - imperfections in manufacture.
- Environmental error - solar heating of the sensor.
- Ice accretion on the probe.
- Heating error - adiabatic and kinetic (friction) heating

The relationship between heating error, SAT and TAT is shown:-

$$\text{SAT} = \text{TAT} - \left(\frac{V}{100}\right)^2$$

Where:

V is the true airspeed in knots

SAT is the Static Air Temperature

TAT is the Total Air Temperature

TAT = SAT + Ram Rise

Note: Calculations of RAM Rise can be achieved on Navigation Computers using the Blue Segment on the reverse, with regard to TAS in knots.

Errors due to adiabatic or frictional heating can be calculated and allowed for by use of the following correction formula.

$$\text{SAT} = \frac{\text{TAT}}{1 + 0.2 \text{ Kr } M^2}$$

where:

SAT = Correct outside air temperature

TAT = Indicated outside air temperature

M = Mach number

Kr = Recovery factor of the temperature bulb

Temperatures are in Absolute (or °Kelvin). "Kr" is determined by flight testing, and its value is to be found in the operating instructions for the aircraft.

$$\begin{aligned} \text{Total Air Temp (TAT)} &= \text{Static Air Temp (SAT)} + \text{Ram Rise} \\ &\text{or} \\ \text{Total Air Temp (TAT)} &= \text{Outside Air Temp (OAT)} + \text{Ram Rise} \\ &\text{or} \\ \text{Indicatted Outside Air Temp (IOAT)} &= \text{Corrected Outside Air Temp (COAT)} + \text{Ram Rise} \end{aligned}$$

Temperature Rise Scale - Navigation Computer.

Except at very low speeds Indicated Outside Air Temperature (IOAT) is always warmer than Corrected Outside Air Temperature (COAT) and this is due to a combination of kinetic and adiabatic heating. The heating that creates this difference is a function of speed, and the "Temp Rise" scale (in blue) of the Navigation Computer gives the amount of "over-indication" of temperature at different True Air Speeds.

If COAT is not available but IOAT is, it is possible to find the correct value of TAS and Temperature but in two stages.

Firstly an approximate Ram Rise value may be found using IOAT to assess TAS, this is then subtracted from the original IOAT to obtain COAT and then used to find a more accurate TAS.

Method:

1. Compute TAS from CAS using IOAT and altitude to give an approximate TAS value.
1. On the "Temp Rise" scale use the approximate TAS value to determine the value of temperature rise.
3. Subtract the temperature rise from IOAT to find COAT.
4. Recompute TAS using COAT and altitude.

Calculation:

IOAT -30°C Altitude 25,000ft CAS 200kts

1. Airspeed window (-30° / 25,000ft) shows: Outer Scale approx TAS 297
Inner Scale CAS 200
2. Temp Rise scale gives rise of 9°C for TAS 297kts.
3. Subtract 9°C from IOAT to find COAT -30° - 9° = -39°C
4. Recompute TAS using new COAT and original CAS / Alt = TAS 292kts.

Caution - if TAS initially computed is greater than 300kts allowance must also be made for compressibility as indicated below:

IOAT -30°C Altitude 25,000ft CAS 250kts

1. Determine approx TAS as before = 372kts.
2. Correct for compressibility $372/100 - 3 = 0.72$ units = revised TAS 369kts.
3. Use this value to determine Temperature Rise = 14°C.
4. Apply temperature rise to IOAT to obtain COAT (-30° - 14°) = -44°C.
5. Using COAT and altitude calculate updated TAS = 362kts
6. Correct for compressibility again $362/100 - 3 = 0.62$ units = final TAS 358kts.

BOEING 737 TEMPERATURE CORRECTIONS.

Most jet transport aircraft are provided with a table giving corrected TAT and the B737 table follows.

	INDICATED MACH NUMBER										
	.30	.40	.50	.60	.70	.73	.76	.78	.80	.82	.84
TAT - °C	STATIC AIR TEMPERATURE -°C										
70				47	39	37	35	33	31	29	27
65			49	42	35	33	30	28	26	25	23
60		49	44	37	30	28	25	24	22	21	19
55	49	45	40	33	26	24	21	19	18	16	14
50	45	40	35	28	21	19	17	15	13	11	10
45	40	35	30	23	17	15	12	11	9	7	5
40	35	30	25	19	12	10	8	6	4	3	1
35	30	26	20	14	8	6	3	1	0	-2	-3
30	25	21	16	10	3	1	-1	-3	-5	-5	-7
25	20	16	11	5	-2	-3	-6	-7	-9	-11	-12
20	15	11	6	0	-6	-8	-10	-12	-13	-15	-16
15	10	6	2	-5	-11	-13	-15	-16	-18	-19	-21
10	5	1	-3	-9	-15	-17	-19	-21	-22	-24	-25
5	0	-3	-8	-14	-20	-21	-24	-25	-27	-28	-29
0	-5	-8	-13	-18	-24	-26	-28	-30	-31	-33	-34
-5	-10	-13	-18	-23	-29	-31	-33	-34	-35	-37	-38
-10	-15	-18	-22	-28	-33	-35	-37	-39	-40	-41	-43
-15	-20	-23	-27	-32	-38	-39	-42	-43	-44	-46	-47
-20	-24	-27	-32	-37	-42	-44	-46	-47	-49	-50	-51
-25	-29	-32	-36	-42	-47	-49	-51	-52	-53	-55	-56
-30	-34	-37	-41	-46	-51	-53	-55	-57	-58	-59	-60
-35	-39	-42	-46	-51	-56	-58	-60	-61	-62	-63	-65
-40	-44	-47	-51	-56	-61	-62	-64	-65	-66	-68	-69

QUESTIONS

1. Converted into degrees Celsius - 40°F is:
 - a. -56.5°C
 - b. -40°C
 - c. -20°C
 - d. -108°C

 2. In an aircraft thermometer with an electrical resistance sensor to measure the air temperature, the resistance wire element is probably:
 - a. plutonium
 - b. platinum
 - c. potassium
 - d. beryllium copper

 3. Flying at high speed at high altitude, the difference between ram air temperature and static air temperature is:
 - a. likely to be less than when flying low and slow.
 - b. due to adiabatic cooling.
 - c. due to adiabatic warming.
 - d. proportional to the square of the absolute temperature.

 4. Aircraft air temperature thermometers are shielded to protect them from:
 - a. solar radiation.
 - b. accidental physical damage on the ground or hailstones in flight.
 - c. airframe icing.
 - d. kinetic heating.

 5. At a true airspeed of 500 knots, a ram rise of air temperature can be expected of:
 - a. 50°C
 - b. 25°C
 - c. 5°C
 - d. 16°C

 6. An air temperature probe may be aspirated in order to:
 - a. prevent icing.
 - b. measure air temperature on the ground.
 - c. compensate for thermal soaking at the ramp position.
 - d. reduce the effect of solar radiation.

 7. Total Air Temperature is:
 - a. the maximum temperature attainable by the air when brought to rest, adiabatically.
 - b. the temperature indicated on the air temperature thermometer plus the ram rise.
 - c. the static air temperature minus the recovery factor.
 - d. the recovery factor plus the ram rise.
-

8. The difference between static air temperature and total air temperature is known as:
 - a. corrected outside air temperature.
 - b. the ram rise.
 - c. the recovery factor.
 - d. hot ramp radiation.

9. A direct reading aircraft thermometer usually consists of a bimetallic helix protruding into the airstream. Movement of the pointer over the temperature scale will depend upon:
 - a. difference in electrical resistance of the two metals.
 - b. increase in pressure as airspeed increases.
 - c. increase in adiabatic cooling as airspeed increases.
 - d. different coefficients of expansion of the two metals.

10. A remote reading thermometer depends upon to indicate changes in temperature:
 - a. change of electrical resistance of the two metals.
 - b. change of electrical resistance with temperature.
 - c. change of electrical resistance with change in pressure.
 - d. change of electrical capacitance with change in temperature.

ANSWERS

- | | | | |
|---|---|----|---|
| 1 | B | 6 | B |
| 2 | B | 7 | A |
| 3 | C | 8 | B |
| 4 | A | 9 | D |
| 5 | B | 10 | B |

CHAPTER FOUR
THE AIRSPEED INDICATOR

Contents

PRINCIPLE OF OPERATION	43
CONSTRUCTION	43
CALIBRATION	44
ASI ERRORS	44
SAMPLE DISPLAYS	48
BLOCKAGES AND LEAKS	49
SERVICEABILITY CHECKS	49
QUESTIONS	50
ANSWERS	52

PRINCIPLE OF OPERATION

The notes on pressure heads explain that whereas an aircraft on the ground in still air is subject only to atmospheric (static) pressure (S), the leading edges of an aircraft in forward flight are subject to an additional (dynamic) pressure. This results in a total (pitot) pressure (P) on the leading edges of dynamic pressure plus static pressure.

$$\begin{aligned} \text{Pitot} &= \text{Dynamic} + \text{Static} \\ \text{or } P &= Dy + S \end{aligned}$$

The dynamic pressure is often called 'pitot excess' pressure (PE) so we have:-

$$P = PE + S$$

The pitot head senses pitot pressure and the static/vent senses static pressure. These two pressures are fed to the airspeed indicator, a differential pressure gauge, which measures their difference PE (the dynamic pressure). Now dynamic pressure is a measure of airspeed, because:-

$$\text{Dynamic Pressure} = \frac{1}{2} \rho V^2$$

where V is true airspeed and ρ is density of the surrounding air.

Thus the ASI measures airspeed by measuring dynamic pressure, displaying the result (usually in knots) on a suitably calibrated scale.

CONSTRUCTION

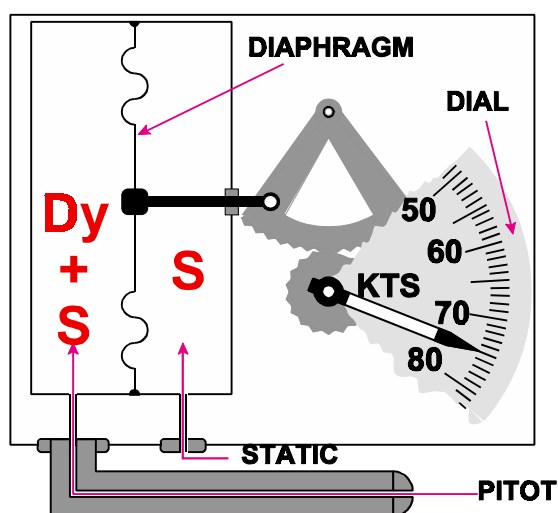

In principle, the simple ASI can be considered as an airtight box divided by a flexible diaphragm, with pitot pressure fed to one side and static pressure to the other side. Figure 4.1 illustrates such a system. The pressure difference across the diaphragm is $(Dy + S) - S$, which is Dy , the dynamic pressure. Accordingly, the diaphragm deflects by an amount proportional solely to this dynamic pressure, its movement being transmitted by a system of levers to the indicating needle on the face of the ASI. Note that static pressure is common to both sides of the diaphragm, and so does not influence diaphragm movement.

Figure 4.1 Simplified Air Speed Indicator

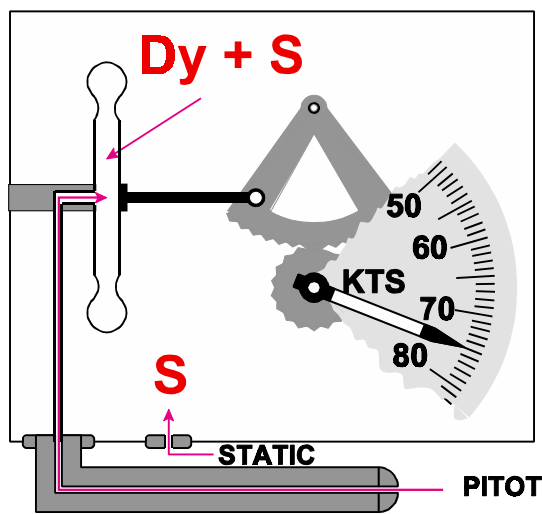

Figure 4.2 Functional Air Speed Indicator

In practice, the static pressure is fed into the hermetically-sealed instrument case, the pitot pressure being piped to a thin metal capsule capable of expansion and contraction. The layout is shown in Figure 4.2.

Note that the pressure differential between the inside and outside of the capsule is $(Dy + S) - S$ which is Dy , as with the diaphragm. Expansion or contraction on the capsule will therefore be proportional to the changes in dynamic pressure produced by changes of airspeed.

The capsule movements are transmitted by a temperature-compensated magnifying linkage to the pointer indicating airspeed on the face of the ASI.

CALIBRATION

From the formula on page 43 it can be seen that dynamic pressure depends not only on the speed of the aircraft but also on the air density.

This density varies with temperature and pressure and so with altitude. The ASI is calibrated to read true airspeed for the air density of 1225 grammes per cubic metre which would be produced by the ISA MSL pressure of 1013.25 mb and temperature + 15°C (dry air conditions). No allowance is made in the calibration for the change in density which occurs with change of altitude.

It follows that even if there were no other errors, the ASI could only indicate TAS when ISA MSL air density existed at the flight level, that is to say when the aircraft was flying in air having a density of 1225 grammes per cubic metre. This density value can only be found at or close to sea level (depending on how much the actual conditions deviate from standard).

ASI ERRORS

Density Error.

Unless the air round the aircraft is at the calibration density of 1225 grammes per cubic metre, which can only occur near sea level, the ASI cannot correctly indicate TAS.

The formula in Paragraph 4.1. shows that dynamic pressure is proportional to density, so at altitude, where density is less, the dynamic pressure generated by a given TAS will be less than for the same TAS in flight at sea level. ASI capsule expansion will be proportionately less and the speed indicated will be less than the true speed.

Summarising, the ASI under-reads the true speed at altitude, the discrepancy being called 'density error'. If below MSL, the ASI will over read the true speed.

The navigational computer is commonly used to correct for density error, computing true airspeed from CAS (the 'Calibrated' Air Speed obtained by applying corrections for instrument and position errors to the reading of the ASI). In the Airspeed window, set pressure altitude against Corrected Outside Air Temperature (COAT); then read off TAS on the outer scale against CAS on the inner scale.

This computation allows for the height of the aircraft above the calibration 1013.25 mb pressure level (which should be set on the altimeter subscale) and also for temperature deviation from standard conditions.

Summary:

$$\text{CAS} + \text{correction for density error (nearly always +)} = \text{TAS}$$

Problem

If the temperature at FL 100 is ISA minus 15°C (SAT = - 20°C), will the TAS for a given CAS be greater or smaller than in standard conditions?

Solution

TAS will be smaller in the lower temperature conditions. If the CAS is kept the same as in standard conditions, the dynamic pressure must be the same.

So $\frac{1}{2} \rho V^2$ is unchanged and since a lower temperature must increase the air density, then V, the TAS, must be less to preserve the balance of the equation ($D_y = \frac{1}{2} \rho V^2$).

Instrument Error

Manufacturing imperfections and usage result in small errors which are determined on the ground under laboratory conditions by reference to a datum instrument.

A correction card can be produced for the speed range of the instrument.

Position Error

Alternatively known as 'pressure' error, this arises mainly from the sensing of incorrect static pressure, and is described more fully in the section entitled Pressure Heads.

Position errors throughout the speed range are determined by the aircraft manufacturer during the test flying programme for a particular aircraft type.

It is not unusual to compile a joint correction card for position and instrument errors and place it in the aircraft near the ASI concerned.

Summary:

$$\text{IAS (indicated air speed)} \pm \text{P and I correction} = \text{CAS}$$

Manoeuvre-Induced Errors.

These are associated chiefly with manoeuvres involving change in angle of attack, giving transient errors and a lag in the indication of changes in airspeed.

Chapter 2 (Pressure Heads) covers this subject in greater detail.

Compressibility Error

Air is compressible and except at true airspeeds below about 150 knots where the effect is negligible, the pressure produced in the pitot tube is higher than it would be for an ideal incompressible fluid, for which the dynamic pressure is $\frac{1}{2} \rho V^2$.

The ASI is calibrated to this ideal incompressible flow formula instead of to a more complex compressible flow formula.

Because of this, the instrument will over-read, IAS and CAS will be too high, and a subtractive compressibility correction will have to be applied preferably before correcting for density error, i.e. to CAS giving what is known as EAS (equivalent airspeed).

The correction, which exceeds 20 knots if TAS is near the speed of sound, can be obtained from graphs or tables, or it can be applied by most high speed navigation computers.

With true airspeeds of less than 300 knots the error is small enough to be ignored in the calculation of TAS from IAS.

With most ASIs, compressibility error appropriate to IAS mean sea level conditions is allowed for in the calibration of the instrument.

Order of Correction

1. Apply P and I correction to IAS, giving CAS.
2. At high speeds, apply the subtractive compressibility correction to CAS to give EAS.
3. From CAS or EAS, obtain TAS by use of the computer (or a special chart) to correct for density error.

Air Speed Definitions

IAS(Indicated Air Speed)	=	indicated reading on instrument
CAS(Calibrated Air Speed)	=	IAS \pm correction for instrument & position error
EAS(Equivalent Air Speed)	=	CAS \pm compressibility corrections
TAS(True Air Speed)	=	CAS \pm density error \pm compressibility error or EAS \pm density error

More ASI Definitions

V_{S0} = The stall speed or the minimum steady flight speed in the landing configuration.

V_{S1} = The stall speed or the minimum steady flight speed in a specified configuration.

V_{FE} = The maximum Flap Extension speed

V_{NO} = The maximum normal operating limit speed.

V_{NE} = The Never Exceed speed

V_{LO} = The maximum Landing Gear Operation speed (up or down).

V_{LE} = The maximum speed Landing Gear Extended speed

V_{YSE} = Best rate of climb when Single Engine (2 eng a/c)

Some ASI=s incorporate coloured markings on the dial - these >range markings' consist of coloured arcs and radial lines.

The White Arc denotes the flap operating range, from stall at maximum AUW in the landing configuration (full flap, landing gear down, wings level, power-off) up to V_{FE} (maximum flaps extended speed).

The Green Arc denotes the normal operating speed range, from stall speed at maximum all-up weight (flaps up, wings level) up to V_{NO} (normal operating limit speed or maximum structural cruising speed) which should not be exceeded except in smooth air. Operations at IASs in the green arc should be safe in all conditions, including turbulence.

The Yellow Arc denotes the caution range, which extends from V_{NO} (normal operating limit speed) up to V_{NE} (the never exceed speed). The aircraft should be operated at IASs in the caution range only in smooth air.

A **Red Radial Line** denotes V_{NE} , the never exceed speed. Some ASI=s have blue radial lines to denote certain important speeds, (e.g. best single-engines speed for a light twin-engined aeroplane).

Optionally for piston engined light twins:

A **Blue Radial Line** denotes the best rate of climb speed for one engine out, maximum weight, at mean sea level (V_{YSE}).

A **Red Radial Line** denotes the minimum control speed at maximum weight (V_{MCA}).

TOLERANCE - (JAR 25) - $\pm 3\%$ or 5 Kts whichever is the greater



SAMPLE DISPLAYS

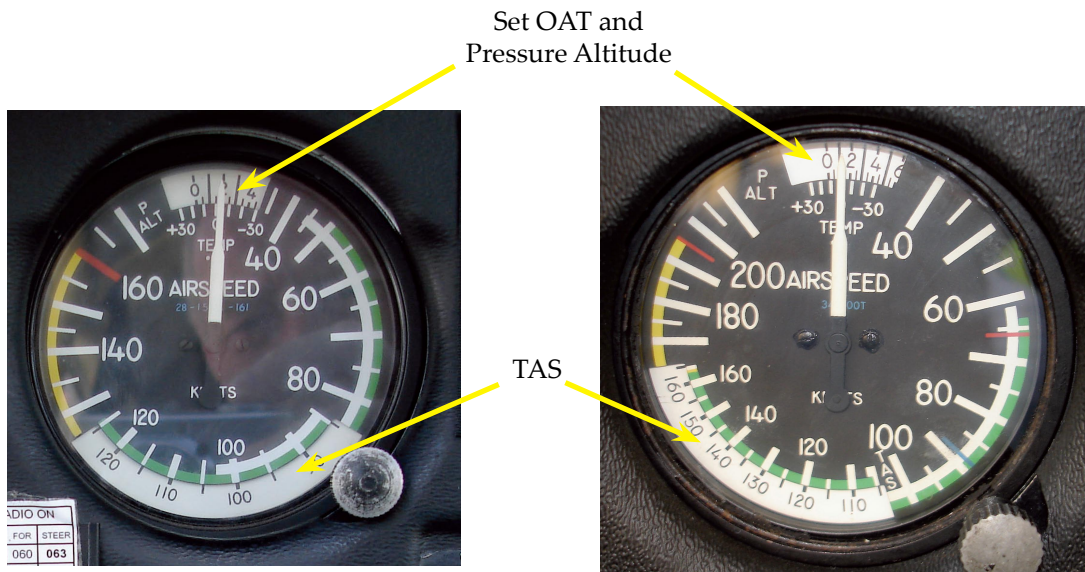

ASI fitted to a Single Engine Aircraft

ASI fitted to a Light Twin Engine Aircraft

Some ASIs, fitted to light aircraft, have the facility to read an approximate TAS. There is an additional scale in which the pilot sets the Outside Air Temperature against the Pressure Altitude of the flight. The approximate TAS can then be read in another window. The pointer now reads both IAS and TAS.

A useful formula for estimating TAS is: $TAS = CAS + (1.75\% \text{ of CAS per } 1,000 \text{ ft of Altitude})$.
 For a CAS of 100 kt at 10,000 ft: $TAS = CAS + (1.75 \times 100 \times 10) = 117.5 \text{ kt}$

Accurate calculation of TAS from CAS will be covered in General Navigation - Book 10.

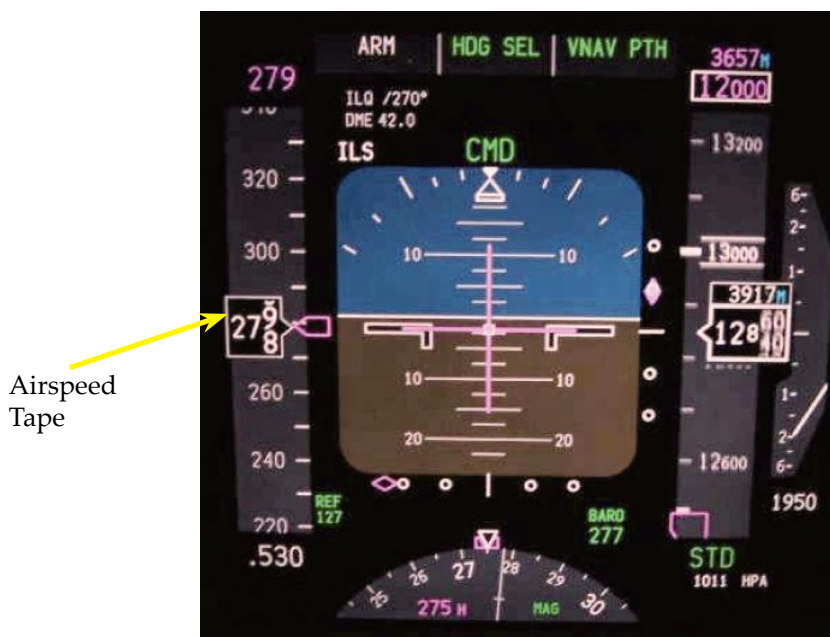

Full Electronic Display Fitted to a Boeing 737

BLOCKAGES AND LEAKS

Pitot Head

If the pitot head becomes blocked, the ASI reading will, in general, remain unchanged.

In level cruise, a blockage (probably ice) will lock in the previous pitot pressure and any change in actual airspeed will not be registered. However, a slow leakage in the pitot pipeline is likely, so that the IAS gradually decreases.

If altitude is changed with a blocked pitot head and clear static source, the IAS will increase during a climb because the pressure locked inside the capsule remains constant while the static pressure of the air surrounding the capsule decreases. Conversely the IAS decreases during a descent with blocked head.

Static Head

A static head is more exposed to icing conditions and is therefore more likely to become obstructed than is a static vent.

A blocked static source during descent will mean that the 'old' (higher altitude) static pressure surrounding the capsule will be lower than it should be, so that if the pitot supply is normal the ASI will over-read. This could be dangerous in that the aircraft is nearer the stall than the ASI is indicating.

Note: A climb with blocked static source and normal pitot air will result in the ASI under-reading.

If the alternative static source is selected an error may occur. This error will be due to position error. Any dynamic, or turbulence, effects would usually result in a higher static pressure and thus produce an under-reading.

Leaks

Leaks can occur either inside or outside the pressure cabin. A leak in the pitot tube causes the ASI to under read. A leak in the static tube where the outside pressure is lower than static, some unpressurised aircraft, will cause the ASI to over read. Where the outside air is higher than static, in a pressurised cabin the ASI will under read.

SERVICEABILITY CHECKS

The following checks of the ASI and pressure supply system should be made before flight:-

- Pressure head cover(s) and static vent plug(s) removed and stowed aboard the aircraft.
- Pitot tube(s), holes/slots in static head(s) and/or static vent(s) should be checked free from obvious obstructions such as insects.
- Pitot head heater operative (if fitted).
- Dial glass clean and undamaged.
- The instrument should indicate airspeed in the correct sense shortly after starting the take-off run.

QUESTIONS

1. If the pitot line to an ASI becomes totally blocked during a climb, the ASI reading will:
 - a. decrease, no matter what the actual airspeed is.
 - b. increase, no matter what the actual airspeed is.
 - c. progressively under indicate the value of the airspeed.
 - d. stick at the airspeed showing at the moment of blockage.

2. Compressibility error:
 - a. causes overreading of the ASI at all levels whenever TAS exceeds 300 kt.
 - b. causes overreading of the ASI whenever CAS exceeds 300 kt.
 - c. is calibrated out of the ASI at MSL ISA conditions and only causes overreading when air density is decreased and CAS exceeds 300 kt.
 - d. is calibrated out of the ASI at MSL ISA conditions and only causes overreading when air density is decreased and TAS exceeds 300 kt.

3. If the static line to the ASI becomes blocked during a long descent, a dangerous situation could arise due to the ASI:
 - a. overreading, this indicated speed falsely showing the aircraft to be further from the stalling speed than it actually is.
 - b. underreading, this indicated speed falsely showing the aircraft to be closer to the stalling speed than it actually is.
 - c. underreading, this indicated speed possibly leading to the operation of flaps and/or landing gear at speeds in excess of safety speeds.
 - d. overreading, this indicated speed possibly leading to the operation of flaps and/or landing gear at speeds in excess of safety speeds.

4. An aircraft maintaining a constant CAS and altitude is flying from a cold airmass into warmer air. The effect of the change of temperature on the speed will be:
 - a. CAS will decrease.
 - b. EAS will increase.
 - c. TAS will increase.
 - d. TAS will decrease.

5. The airspeed indicator is calibrated to:
 - a. conditions of the International Standard Atmosphere.
 - b. conditions of the International Standard Atmosphere at MSL.
 - c. an air density of 1013.25 gms/m³.
 - d. indicate correctly in any atmosphere.

6. Dynamic pressure is equal to:
 - a. $\frac{1}{2} v\rho^2$
 - b. $\frac{1}{2} \rho v^2$
 - c. $(\frac{1}{2} \rho v)^2$
 - d. $\frac{1}{2} (\rho v)^2$

7. Excluding blockages, the full list of errors of the ASI is:
 - a. instrument error, position error, density error, manoeuvre induced error.
 - b. instrument error, position error, temperature error, compressibility error, manoeuvre induced error.
 - c. instrument error, position error, barometric error, temperature error, lag, manoeuvre induced error.
 - d. instrument error, position error, density error, compressibility error, manoeuvre induced error.

8. Some ASIs have coloured arcs and lines marked on their dials. A yellow arc and a white arc indicate:
 - a. cautionary range and normal operating range.
 - b. flap operating speed range and normal operating range.
 - c. cautionary range and flap operating speed range.
 - d. flap operating speed range and cautionary range.

9. What will be the TAS if cruising altitude is 39 000 ft, temperature is ISA +5 and CAS 200 kt:
 - a. 388 kt
 - b. 383 kt
 - c. 364 kt
 - d. 370 kt

10. If the static line to the ASI becomes blocked during a climb, the ASI reading will:
 - a. increase, no matter what the actual airspeed is.
 - b. progressively under indicate the value of airspeed.
 - c. progressively over indicate the value of airspeed.
 - d. stick at the airspeed showing at the moment of blockage.

ANSWERS

- | | | | |
|---|---|----|---|
| 1 | B | 6 | B |
| 2 | D | 7 | D |
| 3 | A | 8 | C |
| 4 | C | 9 | B |
| 5 | B | 10 | B |

CHAPTER FIVE
THE PRESSURE ALTIMETER

Contents

PRINCIPLE OF OPERATION. 55

CALIBRATION. 55

SIMPLE ALTIMETER 56

SENSITIVE ALTIMETER 57

READING ACCURACY. 58

EXAMPLES OF ALTIMETERS 59

SERVO-ASSISTED ALTIMETERS 60

TOLERANCES 61

ALTIMETER ERRORS 62

BLOCKAGES AND LEAKS. 64

SOME DEFINITIONS 65

TEMPERATURE ERROR CORRECTION 66

MORE DEFINITIONS 67

DENSITY ALTITUDE 67

PRE-FLIGHT ALTIMETER CHECKS. 68

QUESTIONS 71

ANSWERS 74

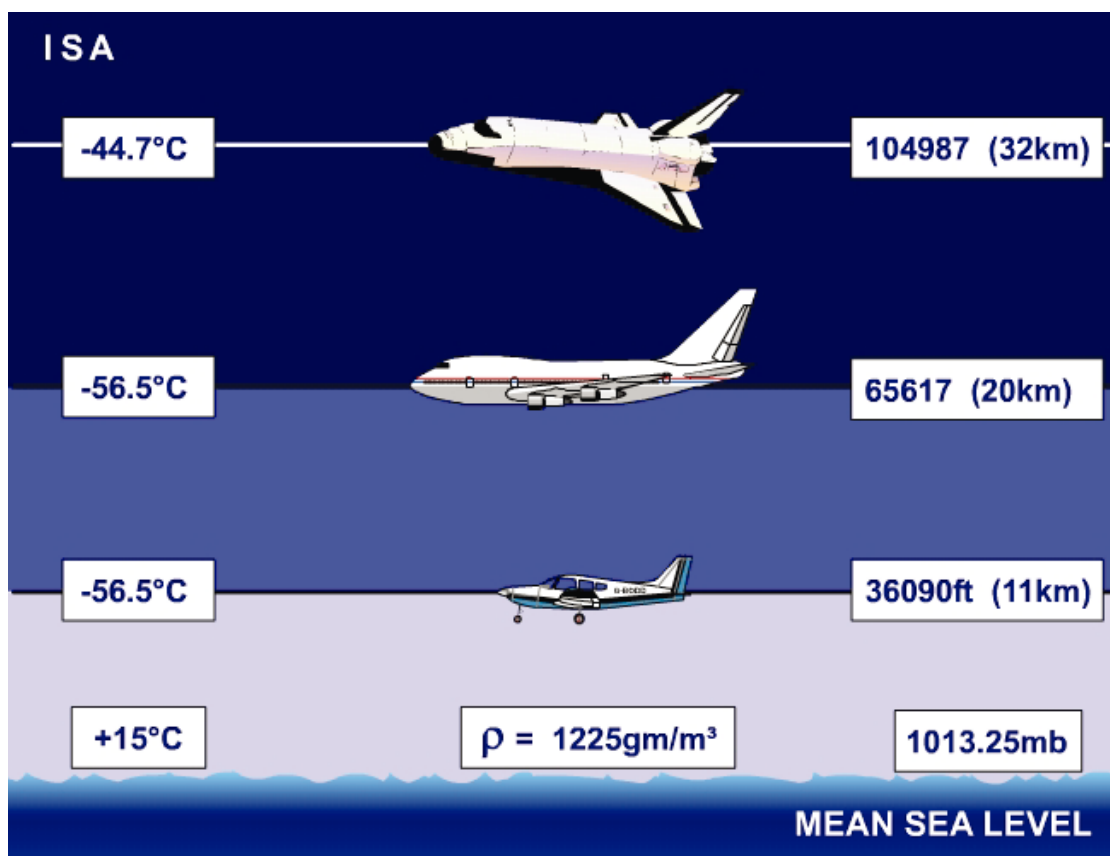

PRINCIPLE OF OPERATION

The pressure altimeter is a simple, reliable, pressure gauge calibrated to indicate height. The pressure at a point depends on the weight of the column of air which extends vertically upwards from the point to the outer limit of the atmosphere.

The higher an aircraft is flying, the shorter is the column of air above it and consequently the lower is the atmospheric pressure at the aircraft.

In other words, the greater the height, the lower the pressure, and by measuring the pressure the altimeter measures height.

Unfortunately, the relationship between pressure and height is not a linear one, so that calibration of the altimeter scale is not a simple matter.

The situation is further complicated by high and low pressure weather systems which produce pressure differences in the horizontal plane. Furthermore, the temperature of the air at the surface and the temperature lapse rate in the air above vary considerably; this affects pressure.

The theory of the atmosphere is explained fully in book 9 - Meteorology.

CALIBRATION

With all these variables it becomes necessary to assume certain average or 'standard' conditions, base the calibration formulae on these, and then apply corrections appropriate to the deviations from standard conditions which occur with position and time.

The conditions used for calibration are usually those assumed for the:

International Standard Atmosphere ISA

The relevant assumptions are:

At mean Sea Level

Pressure 1013.25 millibars Temperature +15°C Density 1225gm m³

From MSL up to 11 km (36,090 feet)

Temperature falling at 6.5°C per km (1.98°C/1000 feet)

From 11 km to 20 km (65,617 feet)

A constant temperature of - 56.5°C

From 20 km to 32 km (104, 987 feet)

Temperature rising at 1°C per km (0.3°/1000 feet).

With these assumptions, the pressure corresponding to any given level in the ISA can be calculated from the calibration formulae.

Graphs or tables can be produced showing height in terms of pressure under standard conditions. These tables can be used for the manufacturer's calibration of the altimeter scale.

Basically, the laboratory calibration consists of applying a series of pressures to the altimeter and checking that the instrument indicates the respective levels which correspond to these pressures in the ISA.

Any discrepancies, if within certain agreed tolerances, would be listed over the operating height ranges as instrument errors. (The calibration is carried out with increasing and decreasing readings so that the amount of lag at calibration conditions can be determined).

Note 1 The Pressure Altimeter is calibrated to give a Linear Presentation of the Non-linear Atmospheric distribution. This is achieved by the use of a variable magnification lever system and the dynamic design of the capsules.

Note 2: Temperature compensation is achieved by the use of a bi-metal compensator connected in the lever/linkage system.

Note 3: $1013.25 \text{ mb/hPa} = 29.92 \text{ "Hg} = 14.7 \text{ psi}$

SIMPLE ALTIMETER

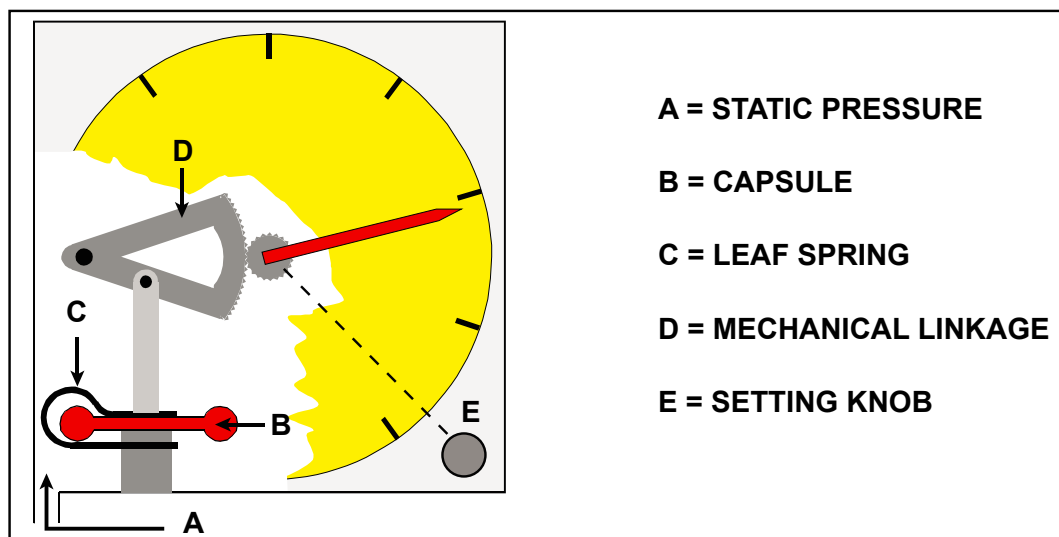

Figure 5.1 Simple Altimeter

Static pressure is fed into the case of the instrument from the static source. As height increases, static pressure decreases and the capsule expands under the control of a leaf spring. A mechanical linkage magnifies the capsule expansion and converts it to a rotational movement of a single pointer over the height scale. The linkage incorporates a temperature-compensating device to minimise errors caused by expansion and contraction of the linkage and changes in spring tension due to fluctuations in the temperature of the mechanism.

Figure 5.1. shows how the basic linkage, but the actual arrangements are much more complex.

The simple altimeter has a setting knob which is geared to the pointer. With this knob the pointer can be set to read zero with the aircraft on the ground so that when airborne the altimeter indicates approximate height above aerodrome level. Alternatively the pointer can be set (before flight) to the aerodrome elevation so that when airborne the instrument shows approximate height above mean sea level.

SENSITIVE ALTIMETER

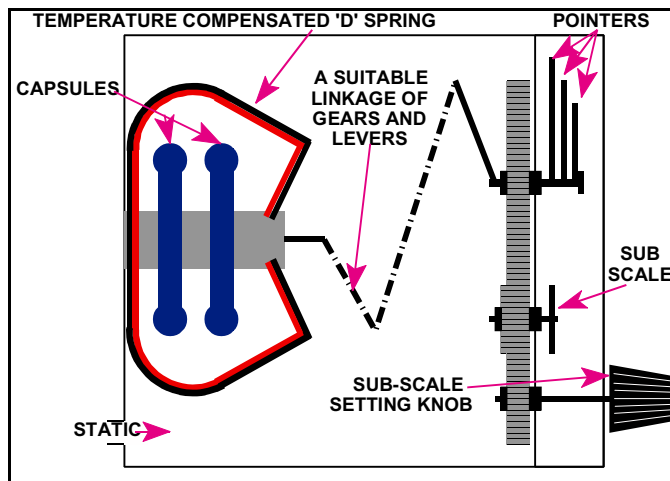

Most aircraft are now equipped with the three-pointer or 'sensitive' type illustrated schematically in Figure 5.2.

Figure 5.2
Sensitive Altimeter

The principle of operation is similar to that of the simple altimeter but there are the following refinements:-

- A bank of two or three capsules gives the increased movement necessary to drive three pointers. These are geared 100:10:1, the smallest indicating 100,000 feet per revolution, the next 10,000 feet per revolution and the largest 1,000 feet per revolution.
- Jewelled bearings are fitted, reducing friction and the associated lag in indications.

Note: Some altimeter systems employ "Knocking / Vibrating" devices to help overcome initial inertia of the internal gear train when transmitting movement from the capsules to the pointers.

- A variable datum mechanism is built in. This, with the aid of a setting knob, enables the instrument to be set to indicate height above any desired pressure datum.

The variable datum mechanism is used as follows:-

The pilot turns the knob until the desired pressure level (say, 1005 mb. appears on a pressure sub-scale on the face of the instrument.

As he turns the knob, the height pointers rotate until, when the procedure is completed with the sub-scale showing the desired 1005, the altimeter indicates the aircraft's height above this pressure level.

If for instance the aerodrome level pressure happened to be 1005 mb, the altimeter would be reading height above the aerodrome (and the pilot would have set a 'QFE' of 1005 on the sub-scale). Further details of the procedural uses of the pressure sub-scale are given later in this chapter. The sub-scale setting only changes when the pilot turns the knob. A change in altitude or surface pressure has no direct effect on the reading of the sub-scale. As the pilot alters the sub-scale setting, the altimeter pointers move, but the design of the mechanism is such that the reverse does not apply (for example, during a climb, the pointers rotate but the sub-scale setting remains unchanged). British altimeters have a sub-scale setting range between 800 to 1050 millibars.

READING ACCURACY

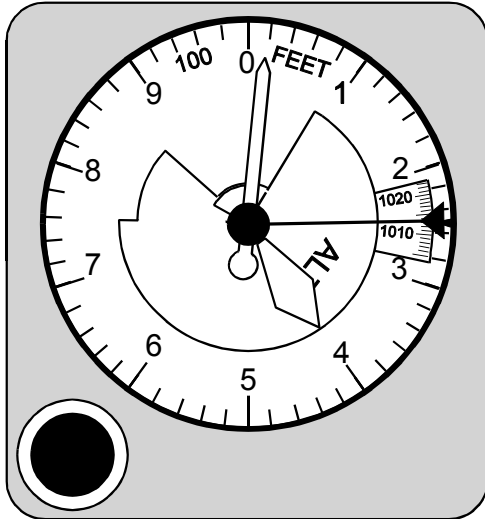

Figure 5.3 Three Pointer Altimeter
Indicating 24,020 ft

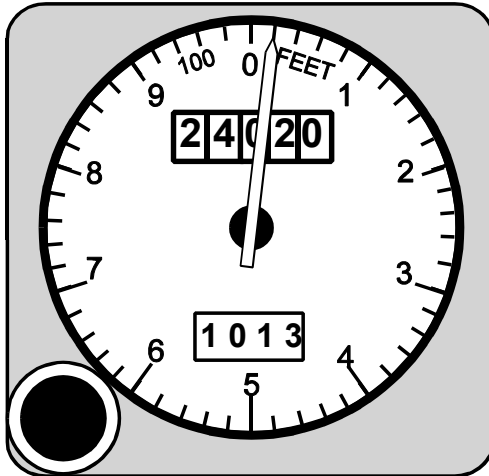

Figure 5.4 Counter / Pointer Altimeter

The simple altimeter is not sensitive, recording perhaps 20,000ft for each revolution of its single pointer. The three-pointer instrument gives a much more sensitive indication of height and change of height but suffers from the severe disadvantage that it can be easily misread.

It is not difficult for the pilot to make a reading error of 10,000ft, particularly during a rapid descent under difficult conditions with a high flight-deck work-load.

Accidents have occurred as a result of such misreading. Various modifications to the pointers and warning systems have been tried with the object of preventing this error, including a striped warning sector which appears as the aircraft descends through the 16,000 foot level.

The greatest advance has been the introduction of the counter-pointer altimeter, illustrated in Figure 5.4., which gives a much more positive indication than the three-pointer dial drawn in Figure 5.3.

With further reference to Figure 5.4., it will be realised that though the digital counters give an unambiguous indication of the aircraft's height, they give a relatively poor display of the rate of change of height.

For this reason the instrument also has a single pointer which makes one revolution per 1000 feet, giving the clear indication of change of height which is extremely important to the pilot, particularly on the final approach in instrument conditions.

EXAMPLES OF ALTIMETERS



A Sensitive Altimeter Reading 260ft



Altimeter Reading
12,850 ft or
3,917 m

Electronic Display fitted to a Boeing 737

Fig 5.5 Altimeter Types

SERVO-ASSISTED ALTIMETERS

Though at least one counter-pointer altimeter driven directly by pressure capsules has been produced, most instruments of the type are servo-assisted. This servo-assistance not only gives the altimeter an increased operating range but also improves the instrument accuracy, particularly at high levels.

At high altitude the change in pressure corresponding to a given change in height is much smaller than at low altitude.

This means that for a given height change, capsule movement at high altitude is relatively small, and frictional resistance in the linkage of an unassisted altimeter causes correspondingly greater errors and more lag. With servo-assistance, the requisite power is available to overcome the frictional resistance with consequently enhanced instrument accuracy.

The principle of the servo-altimeter is that the small movements of the capsules are detected by a very sensitive electro-magnetic pick-off. This produces an electric current which is amplified and used to drive a motor which rotates the counters and pointer.

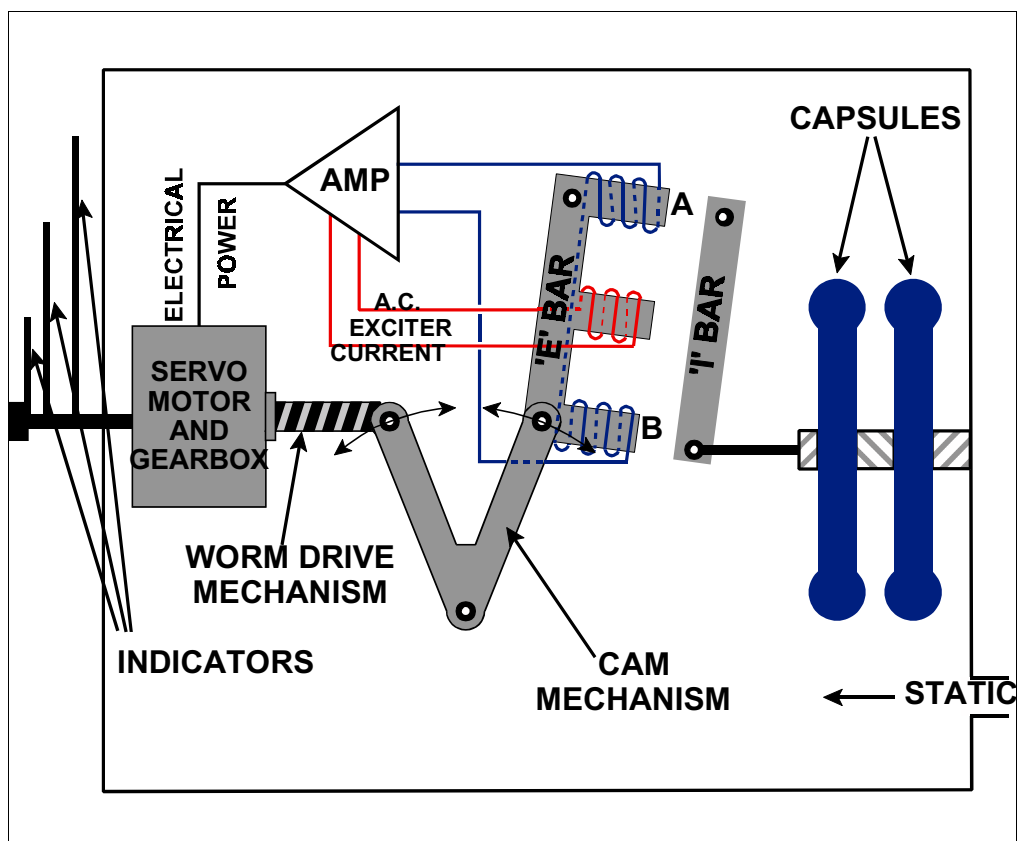

Figure 5.6 Servo Assisted Altimeter Schematic

AC is fed to the middle leg of the E bar, setting up alternating magnetic fields in the outer legs 'A' and 'B'.

The coils on these two legs are wound 180° out of phase. The exciter therefore induces a current in each leg, but since these are 180° out of phase and of equal strength, they cancel each other out when the I bar is equidistant from the legs of the E bar (that is when no pressure change acts on the capsules).

With a change of pressure the capsules expand or contract, moving the I bar on its pivot, closing the gap between the I Bar and E Bar at one end and opening it at the other.

This causes an imbalance of magnetic fields and therefore of the currents induced in the 'A' and 'B' coils . The imbalance causes an error signal which is passed to the amplifier, where it is amplified and rectified, and thence to the servo motor.

The servo motor drives the counter-pointer system of the altimeter and at the same time, via a cam drive, re-aligns the E Bar with the I Bar.

Once re-aligned, the error signal ceases and the altimeter indicates the correct height. In this system the only work required of the capsules is to move the I Bar, eliminating the effects of friction and manufacturing imperfections in the gearing of a conventional altimeter.

This type of altimeter is sensitive to very small pressure changes and therefore more accurate than the sensitive altimeter, particularly at high altitudes where pressure changes (per unit height increment) are very small. The lag experienced in other types of altimeter with rapid changes of height is greatly reduced.

The normal instrument error is approximately equivalent to the effect of 1 mb change of pressure (about 30 ft at msl, 50 ft at 20,000ft, or 100ft at 40,000 ft).

The tolerance at **MSL (JAR - 25)** is **± 30ft per 100 kts CAS**

A further development in the indication of vertical position comes with the Air Data Computer (ADC) installed in many transport aircraft.

The ADC provides (among other things) an electrical output proportional to static pressure which can be used to drive a counter-pointer altimeter, the previously required altimeter pressure capsules being dispensed with, unless a standby capability is required.

TOLERANCES

These values are for example only, and do not have to be learnt.

Typical Simple Altimeter (range zero to 35,000 feet)

Height (feet)	0	35,000
Tolerance (feet)	±100	± 1,000

Typical Sensitive Altimeter (range zero to 80,000 feet)

Height (feet)	0	40,000	80,000
Tolerance (feet)	±70	± 600	± 1,500

Typical Servo Altimeter (range zero to 100,000 feet)

Height (feet)	0	40,000	60,000	100,000
Tolerance (feet)	±30	± 100	± 300	± 4,000

ALTIMETER ERRORS

The errors which affect altimeters are many and the extent of some of them varies with altimeter type. Much effort is expended on improving instrument accuracy, and the permissible tolerances of modern altimeters are smaller than with earlier types.

There are other errors caused by deviation of the actual atmosphere from standard conditions, and also the difficulty in sensing correctly the outside air pressure. A list of the main errors follows.

Time Lag

With many types of altimeter the response to change of height is not instantaneous. This causes the altimeter to under-read in a climb and over-read in a descent. The lag is most noticeable when the change in altitude is rapid and prolonged. In the laboratory calibration of the sensitive altimeter, the lag between increasing readings and decreasing readings should not exceed 150 feet. With servo-assisted altimeters there is said to be no appreciable lag unless the rate of change of height exceeds 10,000 feet per minute. This is because the servo-altimeter does not suffer from the linkage friction which causes a much larger error in the sensitive altimeter.

Instrument Error

Manufacturing imperfections, including friction in the linkage, cause errors throughout the operating range. The errors are kept as small as possible by adjustments within the instrument, and the calibration procedure ensures that they are within permitted tolerances. Residual errors may be listed on a correction card.

Note: With the sensitive altimeter the error increases with altitude, which also explains why the decrease of accuracy with altitude is less serious with the servo-altimeter.

Position (or Pressure) Error

This is largely due to the inability to sense the true static pressure outside the aircraft, as described in the chapter on Pressure Heads. The error is usually small but increases at high mach numbers (and, consequently, at high altitudes usually associated with high mach numbers). Altimeters driven by an Air Data Computer (ADC) may have their accuracy improved by the ADC automatically correcting its static output signal for position error.

Manoeuvre-Induced Error

This is caused by transient fluctuations of pressure at the static vent during change of, mainly, pitch attitude and delays in the transmission of pressure changes due to viscous and acoustic effects in the static pipeline. This is discussed more fully in Chapter 2 dealing with Pressure Heads.

Barometric Error

Providing the altimeter has a pressure sub-scale, and the local QNH is set on it, the altimeter will indicate height AMSL (though still subject to the other errors). If the local surface pressure has changed since the QNH value was set, a 'barometric' error of roughly 30 feet per millibar will result. If pressure has fallen the altimeter over-reads.

Example Problem

Exam questions sometimes include the term 'height involved'. This complicates matters. Think carefully when answering.

An aircraft flies from 'A' to 'B' at a constant indicated altitude of 10,000 feet with the QNH 'A' of 1025 mb set on the sub-scale THROUGHOUT THE FLIGHT. On arrival overhead 'B', where the QNH is 995 mb, what will be the true altitude (assuming that there are no other errors, and assuming that 1 mb corresponds to 30 feet)?

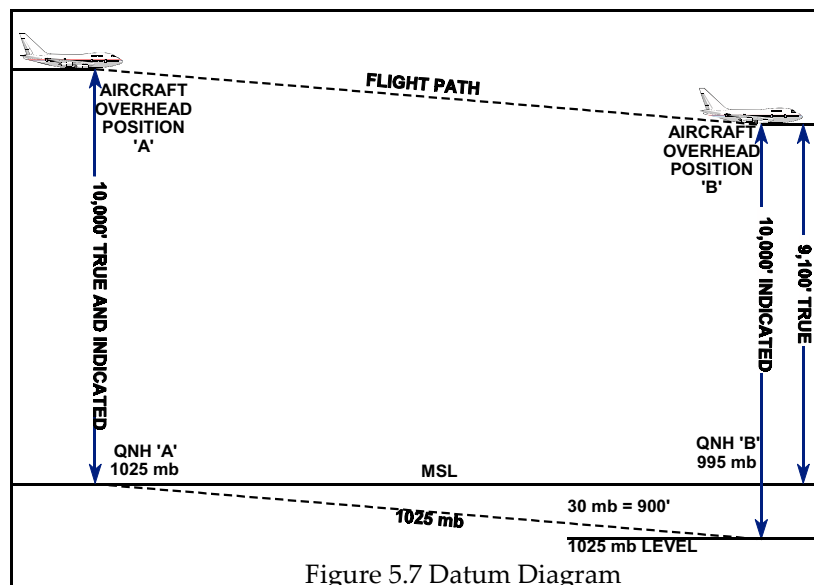

Solution

The altimeter indicates the height above the 1025 mb pressure datum set on the sub-scale. At 'A', 1025 mb is the MSL pressure so the aircraft is actually 10,000 feet above MSL. When it gets to 'B' where MSL pressure is 995 mb, the 1025 mb level will be below sea level, remembering that pressure decreases as height increases. The amount involved is $1025 - 995 = 30$ mb, or $30 \times 30 = 900$ feet. The altimeter is now indicating 10,000 feet above a datum which is 900 feet below MSL. The true altitude (actual height AMSL) of the aircraft must therefore be $10,000 - 900 = 9,100$ feet. The altimeter indicates 10,000 feet but the true altitude is 9100 feet. The instrument is over-reading, and the aircraft is closer to the surface than is indicated. This is a potentially dangerous situation, occurring in flight from HIGH TO LOW pressure causing the altimeter to read HIGH. A datum diagram such as that shown in Figure 5.8 helps to sort out this type of problem.

Remember:

Pressure always decreases as altitude increases.

The altimeter indicates height above the datum set on the sub-scale.

Temperature Error.

Even with no other errors at all, the pressure altimeter will not indicate true altitude (height AMSL) unless the surface temperature and lapse rate of the column of air are those assumed in the calibration.

When flying in colder air (with an air density greater than ISA at that altitude), the altimeter will over-read.

Where the temperature at cruising level deviates from standard, an approximate correction can be made with most navigational computers. The correction can only be approximate since temperatures in the rest of the column of air are not known. The correction is considered too inaccurate to be worth making at heights above 25,000 feet.

Example Problem

The indicated altitude is 10,000 feet with local QNH set and a COAT (corrected outside air temperature) of -25°C . Will the true altitude be more or less than the indicated value?

Solution

The ISA temperature at 10,000 feet would be about -5°C , so the aircraft is flying in colder-than-standard conditions (ISA minus 20°). Pressure decreases more rapidly in cold than in warm air. Therefore, assuming a constant surface pressure, the pressure at a given true altitude in the cold air will be less than at the same altitude in 'standard' air. The altimeter in the cold air will interpret this lower pressure as a higher altitude and will therefore over-read the true altitude. Using the computer set indicated altitude, 10,000 feet, against a COAT of -25°C in the Altitude window. Read off the true altitude, about 9,250 feet, on the outer scale against 10,000 feet on the inner scale.

(An approximation of 4 feet per 1°C away from ISA per 1000 feet above sea level, may be used as a rough guide). Students should use the mathematical method for exam purposes.

Thus, in **flight from HIGH TO LOW TEMPERATURE the altimeter would read HIGH. This is potentially unsafe**, and is comparable to the case of barometric error illustrated in the previous worked example where with **flight from HIGH TO LOW PRESSURE the altimeter also reads HIGH.**

Standard Setting.

When 1013.25 mb is set on the sub-scale, the altimeter reading is called 'pressure altitude' or 'pressure height', which when stated in hundreds of feet at one of the specified intervals (mentioned earlier in the definition of flight levels) gives the aircraft's flight level. Thus with 1013.25 set, the altimeter indicates height above the 1013.25 datum (subject to the usual errors). This setting is used in the UK above the transition altitude/level.

Regional QNH

More correctly called 'lowest forecast QNH', this setting, provided by the Met. Office, is used to ensure safe terrain clearance. It is the value below which QNH is forecast not to fall in a given period and area.

The value should be lower than the actual QNH anywhere in the area, and if set on the sub-scale, regional QNH will cause the altimeter to under-read (so erring on the safe side - the altimeter showing aircraft to be lower than it actually is).

BLOCKAGES AND LEAKS

Figure 5.8 Static Feed Blocked

If the static source becomes blocked, the altimeter will not register any change in height - the height at which the blockage occurred will still be indicated regardless of any climb or descent. On many aircraft, an alternative source of static pressure will be available (see Page 22)

Should the static line fracture in a pressurised aircraft, the altimeter will show the (lower) cabin altitude rather than aircraft altitude

A fracture in the static line within an unpressurised aircraft will normally result in the altimeter over-reading, due to the pressure in the cabin being lower than ambient due to aerodynamic suction. See Chapter 2 Emergency Static Source.

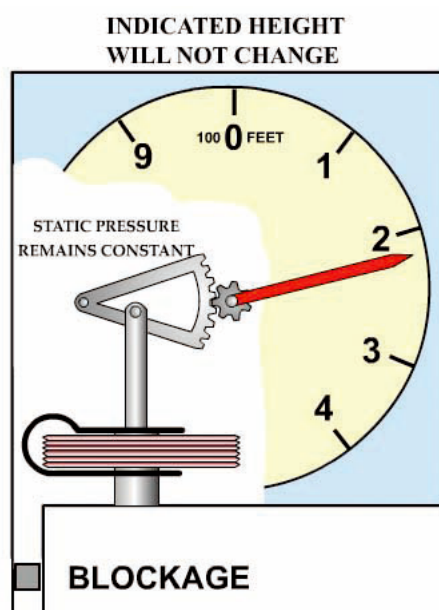
If the aircraft is CLIMBING then the altimeter will UNDER READ.

If the aircraft is DESCENDING then the altimeter will OVER READ.

The amount of the error will increase as the aircraft moves away from the height at which the blockage occurred.

SOME DEFINITIONS

The pilot should be familiar with the following definitions.

Height

The vertical distance of a level, point or object considered as a point, measured from a specified datum. (Normally associated with QFE and height above aerodrome level).

or

The vertical dimension (size) of an object.

Altitude

The vertical distance of a level, point or object considered as a point, measured from MSL. (Normally associated with QNH).

Cruising Level

This is a generic term describing vertical position for a significant portion of the flight and can be a height, altitude, or flight level depending on the altimeter setting procedure in force.

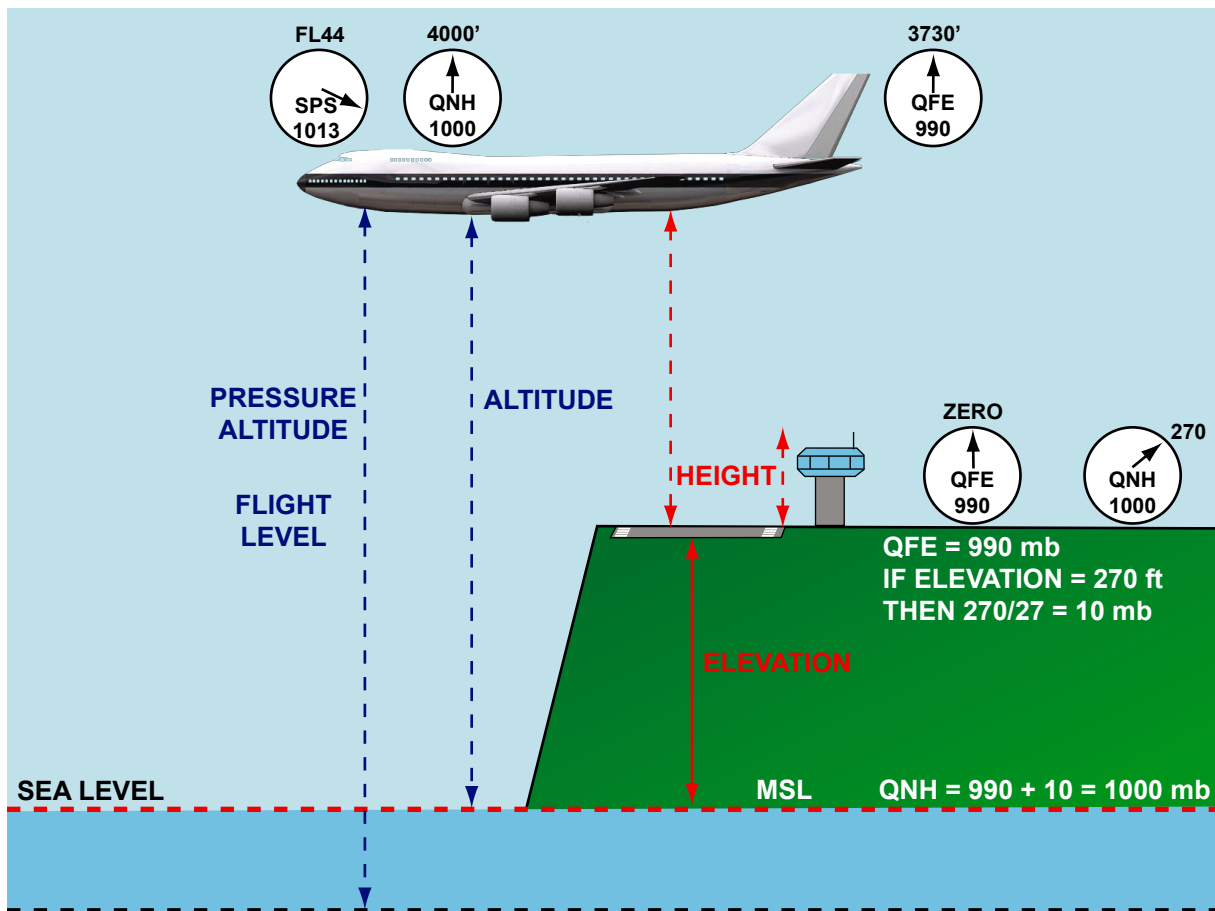

Figure 5.9 Terminology

Flight Levels

Surfaces of constant pressure related to the standard pressure datum and separated by specified pressure intervals. In the UK these correspond to 500 foot intervals between transition level and FL 245 while from FL 250 they correspond to 1,000 foot intervals. A flight level is expressed as the number of hundreds of feet which would be indicated at the level concerned by an ISA-calibrated altimeter set to 1013.25 mb (29.92 inches). For example, with 1013.25 set and 25 000 feet indicated, the flight level would be 250, (abbreviated to FL 250). With 4,500 feet indicated it would be FL 45.

Absolute Altitude

Alternatively known as Absolute Height, meaning the height of the aircraft above the surface immediately below. Used more often in connection with radio or radar altimeters than with pressure altimeters. It should be remembered that the altimeter **indicates height above the pressure level** set on the sub-scale. The four settings are:-

QFE

This is aerodrome level pressure, which when set on the sub-scale, will cause the altimeter of an aircraft on the ground to read zero, assuming there is no instrument error. In flight, with QFE set, the altimeter will indicate height above the aerodrome QFE reference datum, provided ISA conditions obtain between aerodrome level and the aircraft and there are no other altimeter errors. In practice, QFE is used mainly for circuit-flying and gives a good indication of height above the aerodrome, any errors involved being only small.

QNH

This setting is used mainly in flight below transition altitude/level, defined later. It is an equivalent MSL pressure calculated by Air Traffic Control from the aerodrome level pressure assuming ISA conditions prevail between aerodrome level and MSL. With QNH set on the sub-scale, the altimeter of an aircraft on the aerodrome indicates aerodrome elevation, that is, the height AMSL (if there is no instrument error). In flight the altimeter will indicate altitude but this will only be the true altitude if the mean temperature in the column of air beneath the aircraft is the same as in ISA conditions (assuming there are no other altimeter errors). If conditions are different from standard, the indicated altitude, sometimes called QNH altitude, may deviate considerably from true altitude. The navigational computer can be used to make an approximate correction for this temperature error.

TEMPERATURE ERROR CORRECTION

Values to be added by the pilot to published altitudes (feet)

Aerodrome Temp °C	Height above the elevation of the altimeter setting source														
	200	300	400	500	600	700	800	900	1,000	1,500	2,000	3,000	4,000	5,000	
0	0	20	20	20	20	40	40	40	40	60	80	140	180	220	
-10	20	20	40	40	40	60	80	80	80	120	160	260	340	420	
-20	20	40	40	60	80	80	100	120	120	180	240	380	500	620	
-30	40	40	60	80	100	120	140	140	160	240	320	500	660	820	
-40	40	60	80	100	120	140	160	180	200	300	400	620	820	1020	
-50	40	80	100	120	140	180	200	220	240	360	480	740	980	1220	

Note:- The table is based on aerodrome elevation of 2,000 ft; however it can be used operationally at any aerodrome.

Example: Decision height is 400 ft.
Aerodrome temperature is -40 °C.
From table correction = 80 ft.
Revised decision height = 480 ft

MORE DEFINITIONS

Transition Altitude

This is the altitude at or below which the vertical position of an aircraft is expressed and controlled in terms of altitude. In the UK its value is commonly 3,000 or 4,000 feet.

Transition Level

This is the lowest flight level available for use above the transition altitude. At and above transition level, vertical position is expressed as a flight level.

Transition Layer

This is the airspace between transition altitude and transition level. When climbing through it, the aircraft's vertical position is expressed in terms of flight level; when descending through it, in terms of altitude (though in practice the depth of the layer is usually insignificant).

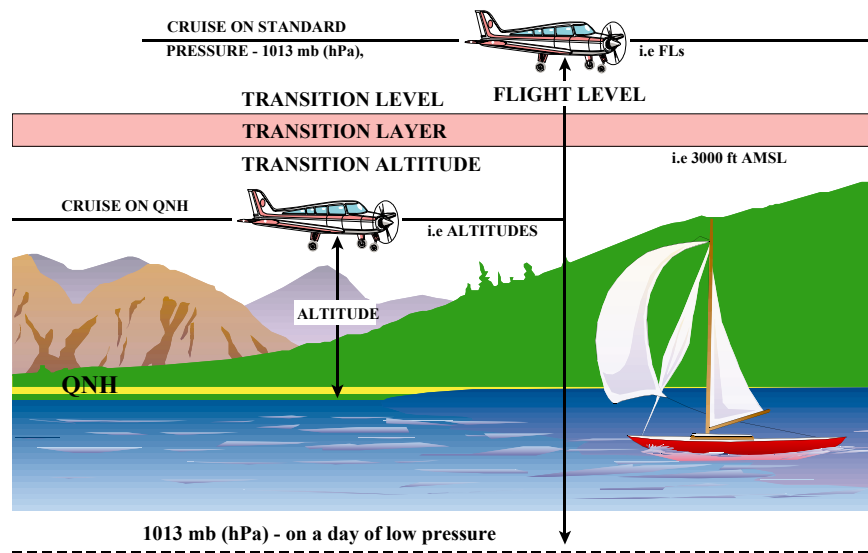

Figure 5.10 Transition

DENSITY ALTITUDE

Density altitude can be defined as the altitude in the standard atmosphere at which the prevailing density would occur, or alternatively, as the altitude in the standard atmosphere corresponding to the prevailing pressure and temperature. It is a convenient parameter in respect of engine performance figures.

It can be obtained by use of an airspeed chart or by navigational computer. The recommended method for use in the exam is that density altitude = pressure altitude adjusted (+ or -) by ISA deviation $\times 120$.

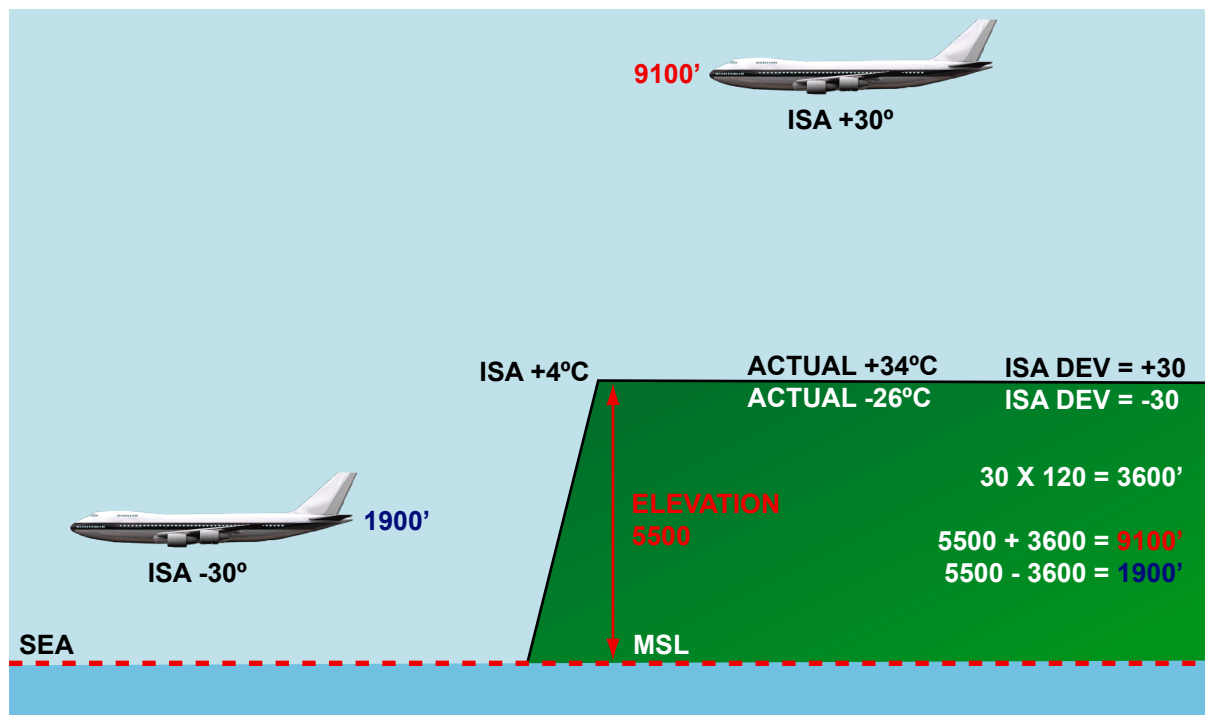

Figure 5.11 Terminology

Example:

Suppose at Nairobi Airport (elevation 5500 ft) that the actual temp (SAT) is + 34°C. On an ISA day the temperature at Nairobi should be + 4. There is, therefore, an ISA deviation of + 30°. If we use the above formula the density altitude can be calculated:

$$\begin{aligned} \text{D.A.} &= 5500 + (+ 30 \times 120) \\ &= 5500 + 3600 \\ &= 9100 \end{aligned}$$

The density altitude (with which the engine performance is associated) would therefore be 9,100 feet. The answer can be checked on the computer by setting pressure altitude (5,500 feet) against temperature (+34°C) in the Airspeed window and reading off Density Altitude (about 9,100 feet) in its own window.

If the SAT in Nairobi fell to -26°C, then the ISA deviation would be -30°. The subsequent Density Altitude would be 1900 feet (5500 - 3600).

Note: When calculating errors in Pressure / Density altitude away from ISA conditions always note the Surface Temperature and Pressure prior to attempting the equation.

The corrections for altimeter error due to deviations away from ISA under specific conditions may be found in Aircraft Operating Manuals.

PRE-FLIGHT ALTIMETER CHECKS.

In the UK, the apron is the designated location for pre-flight altimeter checks (the apron being the loading and unloading and/or parking area). Apron elevation is displayed in the flight clearance office of the aerodrome concerned and is also published in the AGA section of the UK Air Pilot.

Example Problem

Calculate the instrument error from the following details of a pre-flight altimeter check:

Aerodrome elevation	235 feet
Apron elevation	225 feet
Height of altimeter above apron	20 feet
Altimeter reading with QFE set	40 feet

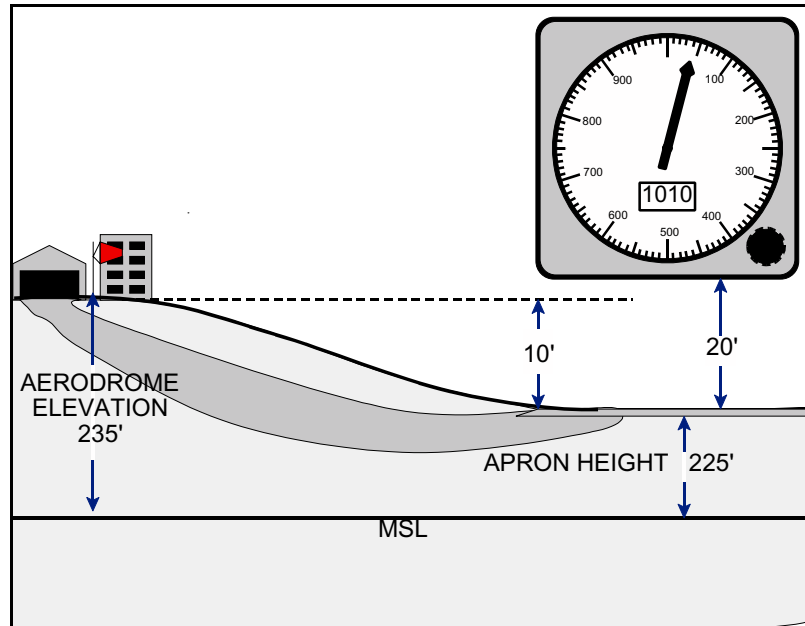

Solution

The apron is 10 feet below the stated aerodrome elevation so assuming the QFE to be for the aerodrome level, an altimeter on the apron should read (-10) feet. However, the instrument is positioned in the aircraft 20 feet above the apron so it should show $(-10) + 20 = +10$ feet. Its actual reading is +40 feet so it is over-reading by 30 feet, an instrument error of +30 feet.

QUESTIONS

1. The diagram below shows a simple altimeter. The parts labelled A, B, C and D are:

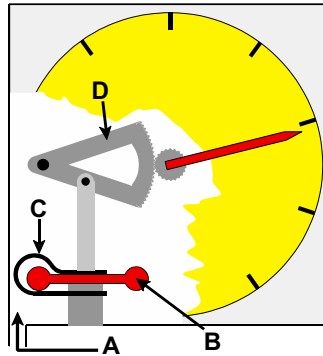

- a. pitot pressure inlet, linkage mechanism, bellows, quadrant.
 b. air inlet, temperature compensator, leaf spring, linkage mechanism.
 c. static pressure inlet, partially evacuated capsule, linkage mechanism, subscale setting device.
 d. static pressure inlet, partially evacuated capsule, leaf spring, linkage mechanism.
2. In the International Standard Atmosphere, the mean sea level pressure is, the lapse rate of temperature between MSL and and is isothermal up to, The numbers missing are:
- a. 1225 mb; 2° per 1000 ft; 37 000 ft; 66 000 ft.
 b. 1013.25 mb; 1.98°C per 1000 ft; 36 090 ft; 65 617 ft.
 c. 1013.25 mb; 1.98°C per 1000 ft; 36 090 ft; 104 987 ft.
 d. 1225 mb; 1.98°C per 1000 ft; 36 090 ft; 104 987 ft.
3. An aircraft taking off from an airfield with QNH set on the altimeter has both static vents blocked by ice. As the aircraft climbs away the altimeter will:
- a. read the airfield elevation.
 b. indicate the aircraft height amsl.
 c. read the height of the aircraft above the airfield.
 d. show only a very small increase in height.
4. When flying from low pressure to high pressure, the barometric error of an altimeter will cause the instrument to:
- a. read the true altitude, providing a correction is made for temperature.
 b. overread the true altitude of the aircraft.
 c. indicate a higher altitude than the correct one.
 d. underread the true altitude of the aircraft.
5. The errors affecting the pressure altimeter are:
- a. instrument position, manoeuvre induced, density, temperature, lag.
 b. instrument, pressure, manoeuvre induced, density, temperature, lag.
 c. instrument, position, manoeuvre induced, temperature, barometric, lag.
 d. instrument, pressure, lag, barometric, temperature, compressibility.

6. An altimeter with set on the subscale will indicate, but with set, the altimeter will show
- 1013; pressure altitude; QNH; height above mean sea level.
 - QNE; pressure altitude; QNH; height above airfield datum.
 - QFE; height above the airfield datum; 1013; height amsl.
 - QNH; height above touch down; 1013; height amsl.
7. An aircraft has one altimeter set to QFE and one to aerodrome QNH 1000 mb. If the airfield elevation is 300 ft, immediately before take-off the altimeter with QFE set will read and the other
- If the QFE altimeter is set to 1013 when passing through the transition altitude 3000 ft, it will read (Assume 1 mb = 30 ft)
- 300 ft; zero; 2610 ft
 - zero; 300 ft; 3390 ft
 - zero; 300 ft; 3690 ft
 - zero; 300 ft; 2610 ft

8. Which altimeter below is showing FL155:

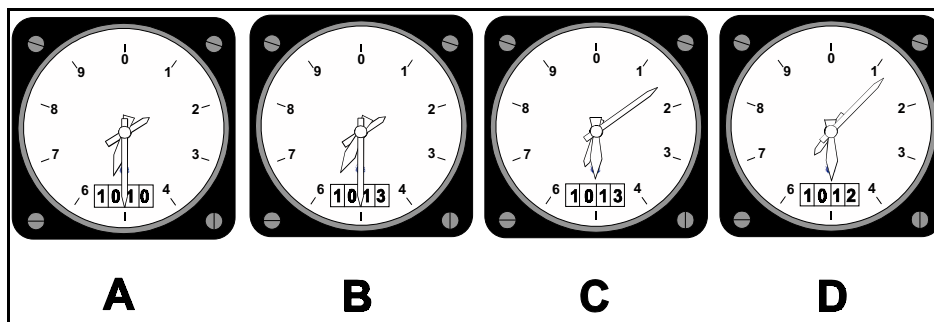

9. Below is a schematic diagram of a servo-assisted altimeter. The parts labelled A, B, C and D are:
- cam mechanism, amplifier, servo motor, mechanical drive.
 - mechanical drive, servo motor, amplifier, AC exciter.
 - cam mechanism, amplifier, E-I bar, mechanical drive.
 - E-I bar, amplifier, servo motor, AC exciter, mechanical drive.

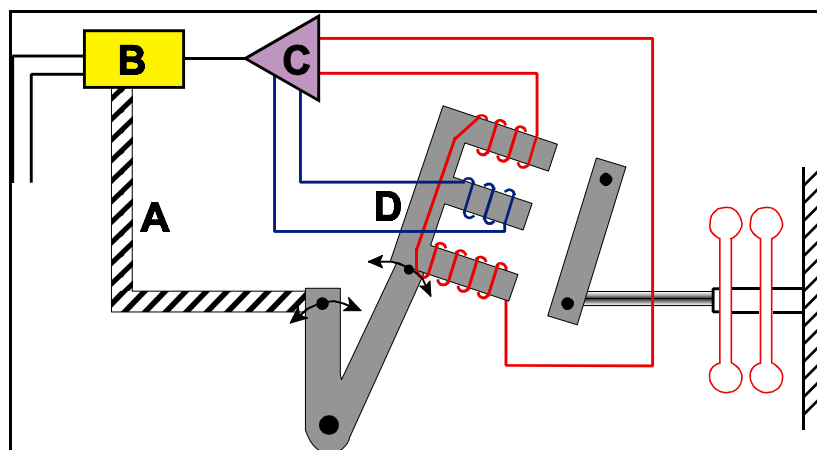

ANSWERS

- | | | | |
|---|---|---|---|
| 1 | D | 6 | A |
| 2 | B | 7 | B |
| 3 | A | 8 | B |
| 4 | D | 9 | B |
| 5 | C | | |

CHAPTER SIX
THE VERTICAL SPEED INDICATOR

Contents

INTRODUCTION 77

PRINCIPLE. 77

CONSTRUCTION 77

VSI METERING UNIT 78

DISPLAY 78

THE ERRORS OF THE VSI. 78

THE INSTANTANEOUS VERTICAL SPEED INDICATOR. 79

PRESENTATION. 80

SERVICEABILITY CHECKS 80

THE ONE IN SIXTY RULE 81

QUESTIONS 82

ANSWERS 84

INTRODUCTION

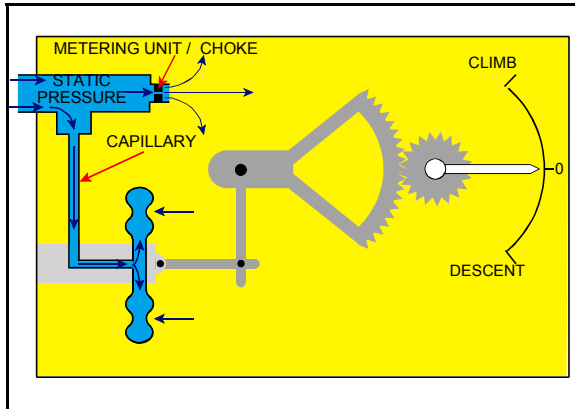

Fig 6.1a

A pilot can get some idea of his rate of climb or descent from the angular rate of change of the altimeter pointer. However, there are times when a more accurate indication is necessary, such as achieving a certain height loss within a specified time on airways or in setting up a smooth rate of descent on a glidepath on an instrument approach.

The Vertical Speed Indicator (VSI) displays rate of climb or descent. The instrument senses rate of change of static by comparing the present static pressure with a recent measurement of static.

The VSI can also be known as the Rate of Climb and Descent Indicator (RCDI) or, in gliders, the Variometer (sometimes 'vario').

PRINCIPLE

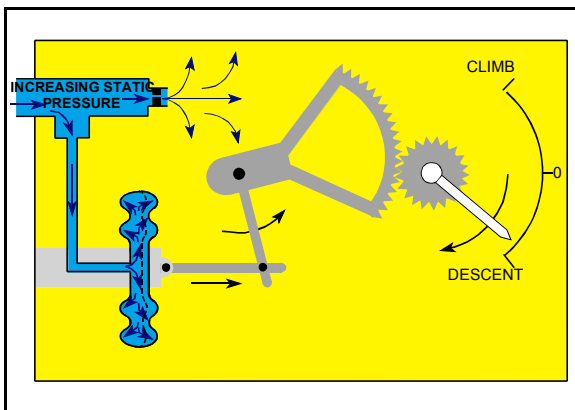

Fig 6.1b

When an aircraft departs from level flight, the static pressure will change. The V.S.I. measures the pressure difference between each side of a restricted choke / metering unit.

In level flight the pressures on each side of the choke are the same, during a climb or descent, air fed to the choke immediately responds to the change of atmospheric pressure but the choke transmits this change at a lower rate.

CONSTRUCTION

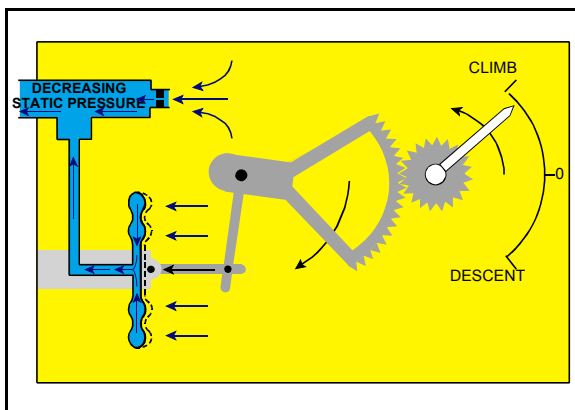

Fig 6.1c

A capsule within an airtight case is fed with static pressure. The case is also fed with static pressure but through a restricted choke, thus if the static pressure is changed the pressure surrounding the capsule changes at a slower rate than that within the capsule, as shown in Figure 6.1. For example, if the aircraft is climbing, the pressure in the capsule will be less than that in the case, the consequent compression of the capsule is converted by a suitable linkage to a pointer indication of rate of climb.

VSI METERING UNIT

The restrictor (or choke, or metering unit) is more complicated than a simple hole. The static pressure change is actually hectopascals/min, but the pilot needs to see an indication of feet/min, whatever the altitude. However, there are more feet to a hectopascal at higher altitudes than lower altitudes, and therefore the rate of pressure change with altitude at different altitudes needs to be compensated for.

This is achieved by a combination of different types of hole (called 'capillary' and 'orifice'). Use of a suitable combination of these gives a near-constant indication in feet/minute, whatever the actual altitude and therefore, whatever the actual pressure differential needed.

DISPLAY



Fig 6.2 The VSI Display

THE ERRORS OF THE VSI.

Instrument Error. Due to manufacturing imperfections.

Position (or Pressure) Error. If the static pressure is subject to position error the V.S.I. will wrongly indicate a climb or descent when speed is suddenly changed, this is most noticeable during take-off acceleration.

Manoeuvre-Induced Error. Any short term fluctuations in pressure at the static vent during attitude changes will cause the instrument to indicate a false rate of climb or descent.

Additionally with most V.S.I.s, the linkage includes a small counterbalance weight, the inertia of which causes delays in the indications of changes in vertical speed during manoeuvres.

Time Lag. The pointer takes a few seconds to steady because of the time taken to build up a steady pressure difference on climb or descent. There will also be a time lag on levelling out because of the time taken for the pressures to equalise. This error is most noticeable after a prolonged climb or descent, especially at a high rate.

Any blockages of the static line or vent will cause the needle to **return to zero**. If the supply of air to this instrument is blocked it is probable that the other pressure instruments (A.S.I., altimeter and machmeter) will also be affected.

THE INSTANTANEOUS VERTICAL SPEED INDICATOR

To overcome the problem of lag, the Instantaneous Vertical Speed Indicator (I.V.S.I) incorporates an accelerometer unit (sometimes called a dashpot or vane-type) which responds quickly to a change of altitude.

The figure below shows an IVSI at the beginning of a descent.

The piston in the vertical acceleration pump immediately rises in the cylinder and causes a temporary increase of pressure in the capsule. The capsule expands and the pointer will give an instant indication of descent.

As the initial acceleration is turned into a steady rate of descent, the piston will slowly descend to its original position, but by this time the correct differential pressure between the capsule and the case will have been set up and the correct rate of descent will continue to be shown.

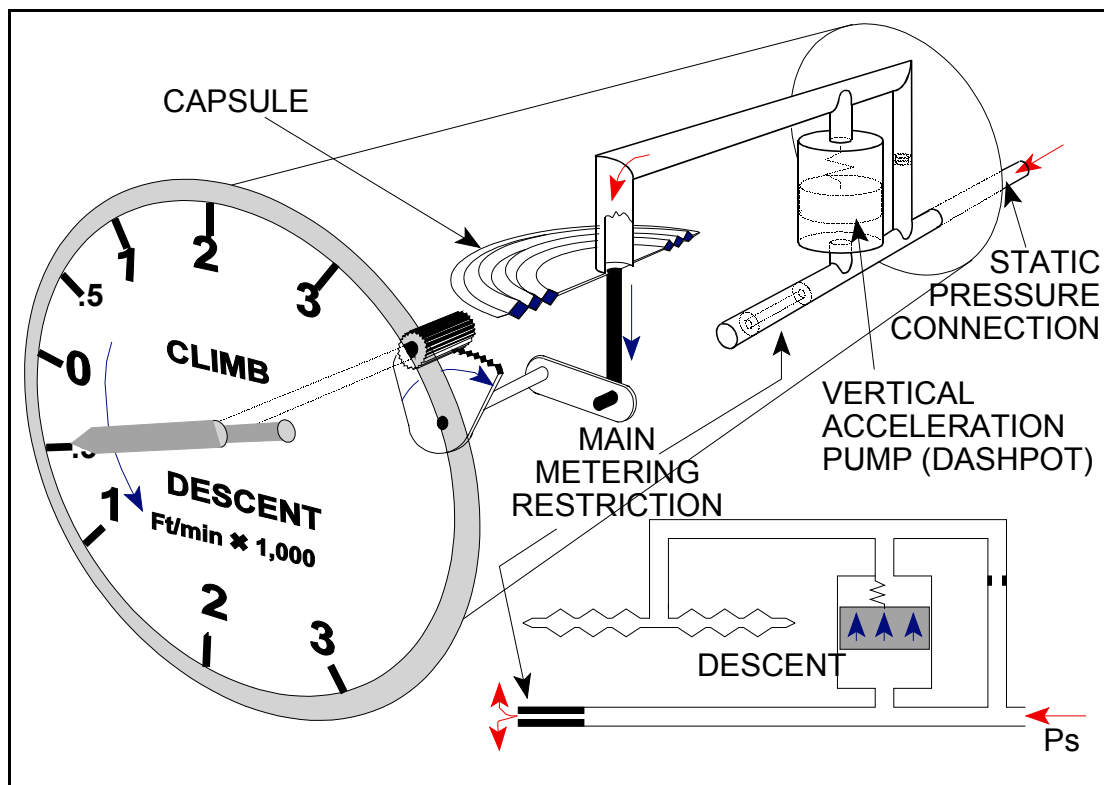

Fig 6.3 The Instantaneous Vertical Speed Indicator

Errors Peculiar to the IVSI. Because of the sensitivity of the dash-pot assembly, the instrument tends to overreact to turbulent flying conditions and small fluctuations should be ignored.

In a steep, level turn, the piston will tend to sink towards the bottom of the cylinder and there will be a false indication of a climb.

PRESENTATION

Two types of presentation are available, a linear scale and a logarithmic scale, this latter presentation being more easily read at the lower rates of climb/descent. This is easily discerned from the figures below.

It should be noted that diaphragm overload stops may be fitted to prevent damage to the instrument should the rate of climb/descent exceed the maximum to which the instrument is calibrated. On some instruments a zeroing screw is fitted.

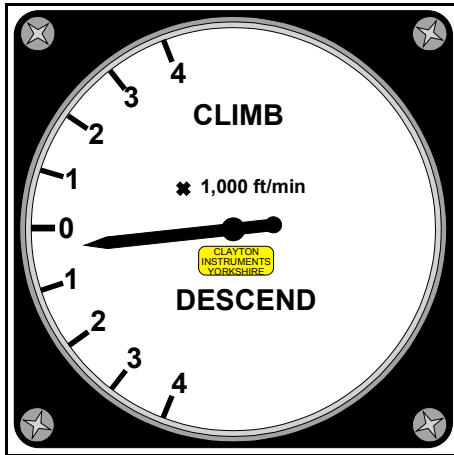

Fig 6.4a Linear Scale

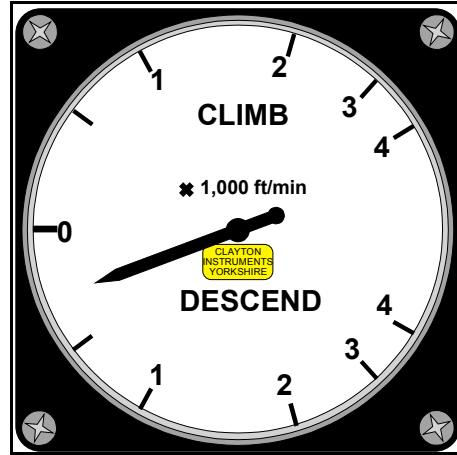

Fig 6.4b Logarithmic Scale

Note 1: The Vertical Speed Indicator as fitted in Glider Aircraft is sometimes known as a "Variometer" (a simple tube device - Green for upward movement / Red for downward movement).

Note 2: The device fitted to the IVSI to give an instant indication of vertical movement may be of the Dashpot or Dynamic-Vane type - the indications and errors being the same for both instrument types.

SERVICEABILITY CHECKS

On the Ground.

- The instrument should read zero, or the error should be within the permissible limits
 - +/- 200 feet per minute at temperatures -20°C + 50°C
 - +/- 300 feet per minute outside these temperatures
- There should be no apparent damage to the instrument.

In The Air

The accuracy of the instrument may be checked against the altimeter and a stop watch during a steady climb/descent and the instrument should indicate zero climb or descent when in level flight.

It is important to understand the use of the VSI on the approach to a landing. The standard glideslope is 3° . This will be dealt with in Radio Navigation. It is, however, reasonable for you to know at this stage that, using trigonometry we can predict the correct Rate of Descent and distance to the runway to give you the "perfect" approach. This can be done using the 1:60 rule.

THE ONE IN SIXTY RULE

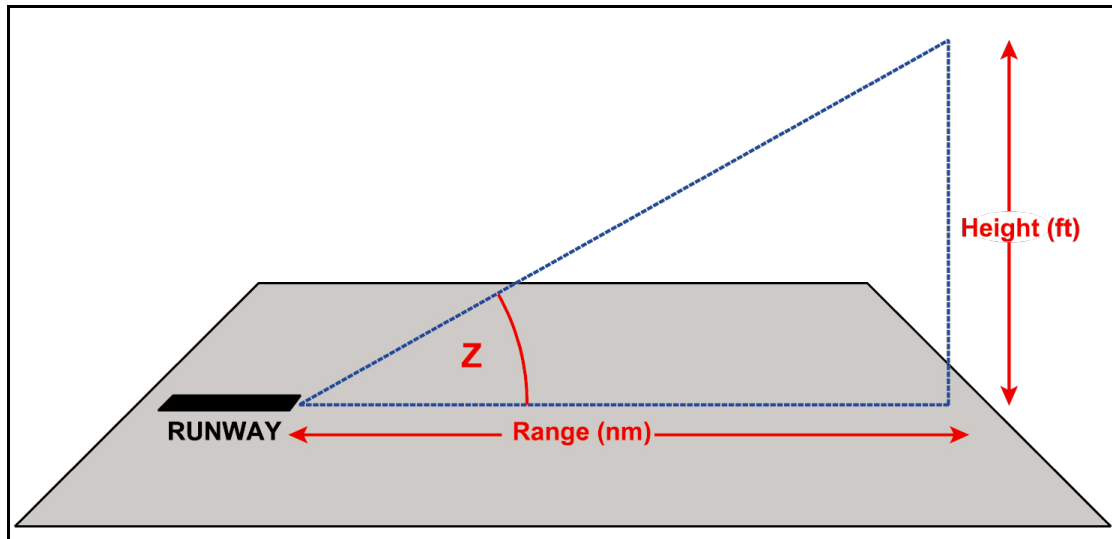

Fig 6.5 The One in Sixty Rule

Using normal trigonometry, $\tan z = \frac{\text{opposite}}{\text{adjacent}}$, which = $\frac{\text{height}}{\text{range}}$

If angle = 3° , and range is one mile (which is 6080 feet), then $\tan 3^\circ = \frac{\text{height}}{6080}$

Therefore the required height at one mile range is $\tan 3^\circ \times 6080 = 319$ feet.

However, there is a quick approximation which can be used for mental arithmetic in the air without the use of a calculator. It is an application of the **one in sixty rule**.

The **one in sixty rule** states that if the range is 60 units long (sixty feet, sixty metres, etc.), then the height will be the same number of units as the angle in degrees. In this case, for a 3° glideslope, the height would be **3 units**.

Therefore, if the range is 6000 feet, the height will be 300 feet. 6000 feet is a slight approximation of 6080, and the use of the one in sixty rule gives us an answer that is slightly low, but is acceptably accurate for practical use in the air.

Therefore, **on a 3° glideslope, the required height is 300 feet per nautical mile.**

Now, take the case of an aircraft with a groundspeed of 60 knots. When it is one mile range from touchdown, it will take one minute. If the aircraft is at 300 feet, the required rate of descent will be 300 feet/min. This leads to a second useful rule:

For a 3° glideslope, the required rate of descent in feet per minute = 5 x groundspeed in knots.

Questions may be asked in the JAA exam on the use of these two rules.

QUESTIONS

1. During a missed approach and go-around procedure the change of aircraft attitude plus raising of the landing gear and changing of flap settings can cause short term unpredictable errors in certain instruments. The instruments most likely to be affected in this case are:
 - a. the altimeter, artificial horizon and vertical speed indicator.
 - b. the airspeed indicator, machmeter and vertical speed indicator.
 - c. the machmeter, airspeed indicator, altimeter and vertical speed indicator.
 - d. the vertical speed indicator, airspeed indicator and altimeter.
2. The vertical speed indicator indications may be in error for some seconds after starting or finishing a climb or descent. The error is a result of:
 - a. a combination of time lag and manoeuvre induced errors.
 - b. a combination of position error and manoeuvre induced errors.
 - c. manoeuvre induced errors only.
 - d. a combination of time lag and instrument error.
3. The advantage of having the VSI dial presentation in logarithmic spacing rather than in linear spacing is that:
 - a. at low rates of climb or descent the pointer movement is much larger and so is more easily read.
 - b. readings are instantaneous.
 - c. a greater range of rates of climb and descent is shown.
 - d. the internal mechanism is simplified by deletion of the calibration choke.
4. In the IVSI, lag error:
 - a. is overcome by feeding a sample of static pressure to the case and delaying it to the capsule.
 - b. is virtually overcome by using a special dashpot accelerometer assembly.
 - c. is overcome by the use of logarithmic presentation.
 - d. is only overcome when initiating a climb or descent.
5. Because the VSI measures rates of change of static pressure and not actual values of static pressure, position error:
 - a. never affects VSI indications.
 - b. may cause errors in the VSI during the take-off run.
 - c. may cause errors in VSI indications whenever airspeed is changed, if at the same time there is a change in position error.
 - d. may cause errors in VSI indications whenever airspeed is changed, even if there is no change in position error.

6. When entering a steep turn, an IVSI is likely to show:
 - a. no change in altitude.
 - b. a slight climb.
 - c. a slight descent.
 - d. a slight descent at high airspeed only.

7. If the static vent becomes blocked during a climb:
 - a. the VSI will stop at the rate of climb of the aircraft at the time of blockage.
 - b. the VSI will indicate a decreasing rate of climb.
 - c. the VSI will return to zero.
 - d. the VSI will indicate an increasing rate of climb.

8. In conditions of clear air turbulence:
 - a. the standard VSI is more sensitive.
 - b. the IVSI is more sensitive.
 - c. both types will react the same.
 - d. the vertical acceleration pump will not be affected.

9. Change of temperature as an aircraft climbs or descends:
 - a. will affect VSI readings whenever temperature lapse rate differs from standard conditions.
 - b. is compensated at the metering unit by means of a capillary and orifice.
 - c. has no effect on the VSI as only static pressure is used in this instrument.
 - d. may be allowed for by use of tables or computer.

10. Permissible limits of accuracy of the VSI are when within a temperature range of and outside this range.
 - a. + 250 fpm, on the ground, -20°C to +50°C, + 300 fpm
 - b. + 200 fpm, at any height, -20°C to +30°C, + 300 fpm
 - c. + 250 fpm, at any height, -20°C to +50°C, + 300 fpm
 - d. + 200 fpm, on the ground, -20°C to +50°C, + 300 fpm

ANSWERS

- | | | | |
|---|---|----|---|
| 1 | D | 6 | B |
| 2 | A | 7 | C |
| 3 | A | 8 | B |
| 4 | B | 9 | B |
| 5 | B | 10 | D |

CHAPTER SEVEN

THE MACHMETER

Contents

HIGH SPEED FLIGHT. 87
CRITICAL MACH NUMBER. 87
SPEED OF SOUND 87
MACHMETER. PRINCIPLE OF OPERATION 88
MACHMETER CONSTRUCTION 88
MACHMETER ERRORS. 89
BLOCKAGES 90
ABBREVIATIONS 90
MACHMETER SUMMARY. 90
CLIMB AT A CONSTANT CAS IN STANDARD (ISA) ATMOSPHERE 91
DESCENT AT A CONSTANT MACH NUMBER IN STANDARD CONDITIONS. 91
CLIMB AND DESCENT THROUGH AN ISOTHERMAL LAYER. 92
CLIMB AND DESCENT THROUGH AN INVERSION 92
CLIMB/DESCENT SUMMARY. 92
EXAMPLE PROBLEMS ASSOCIATED WITH THE MACHMETER 93
MACH / AIRSPEED INDICATOR 94
CONSTRUCTION 94
QUESTIONS 96
ANSWERS 98

HIGH SPEED FLIGHT

In high speed aircraft the **machmeter is an essential instrument**. As an aircraft approaches the local speed of sound the airflow over some parts of the fuselage or wings may be accelerated up to the speed of sound and a **shock wave** will form. These shock waves cause more drag, less lift, Mach tuck, buffeting, and reduction in control effectiveness or loss of control. (Mach tuck is a downward-pitching sudden change of trim which can be severe).

In order to avoid danger associated with flight at high Mach numbers, a limiting Mach number will be specified for each aircraft, based on flight trials. This must not be exceeded. It is known as M_{MO} .

The Machmeter therefore displays the present Mach Number so that the pilot can keep his speed below the particular M_{MO} for his aircraft and avoid the problems associated with high speed flight.

CRITICAL MACH NUMBER

The speed at which airflow over some part of the aeroplane first reaches the speed of sound and a shock wave forms is called the **critical Mach number**, known as M_{crit} .

M_{crit} is not a limit and the M_{MO} of most aircraft is greater than the M_{crit} .

SPEED OF SOUND

The **speed of sound** is not constant but **varies with air temperature**. A formula for calculating the local speed of sound (LSS) is:

$$LSS = 38.95 \sqrt{T}$$

where,

LSS is given in knots,

38.95 is a constant, and

T is the **absolute temperature**, ($0^{\circ}\text{C} = 273^{\circ}\text{A} = 273^{\circ}\text{K}$)

Therefore the higher the air temperature, the higher the speed of sound, and vice versa. Since temperature normally reduces as altitude increases, the speed of sound normally reduces as altitude increases.

In ISA conditions at mean sea level ($+15^{\circ}\text{C}$) the speed of sound is 661.32 knots, while at 30,000 feet ISA (-45°C) the speed of sound will have reduced to 589.18 knots.

MACHMETER. PRINCIPLE OF OPERATION

The machmeter uses two capsules and linkages to indicate the aircraft's True Air Speed (TAS) as a proportion of the local speed of sound (LSS)

The first capsule is an Airspeed Capsule which will expand and contract as a result of changes in the Dynamic pressure.

$$\text{Mach Number} = \frac{\text{TAS}}{\text{LSS}}$$

The second capsule is a sealed Altimeter Capsule which will expand and contract as the static pressure inside the instrument case changes.

However, MN is proportional to.... $\frac{D}{S}$

As Density (ρ) cancels out, we can see that:-

MN is proportional to..... $\frac{D}{S} = \frac{P - S}{S}$

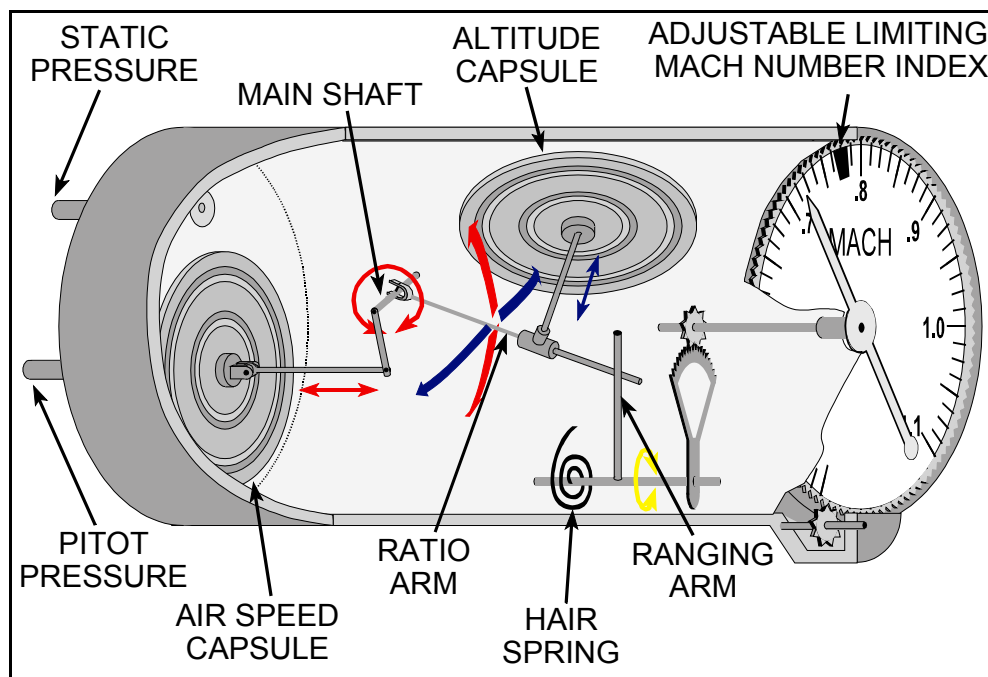

Figure 7.1 The Machmeter

MACHMETER CONSTRUCTION

Figure 7.1 shows the parts of a machmeter (which must be learnt). It consists of a simple aneroid **altimeter capsule** and an **airspeed capsule** which are connected at the ratio arm.

Static pressure enters the case of the instrument, while Pitot pressure is fed directly into the airspeed capsule. Expansion or contraction of the airspeed capsule is transmitted via the airspeed link and **main shaft** to the **ratio arm**, but the position of the ratio arm is also governed by expansion or contraction of the altitude capsule.

A spring-loaded **ranging arm** transmits the movement of the ratio arm to the pointer mechanism.

Basically, if either or both **capsules expand** (due to an increase in IAS and / or altitude) then the ranging arm will rotate out of the diagram and the indicated **Mach Number will increase**. If airspeed or altitude reduce then the ratio and ranging arms move back into the paper, and a lower Mach Number is displayed.

An **adjustable index** on the instrument scale can be positioned by means of a small knob. This index can be set to the **limiting Mach Number** for the aircraft type (in straight and level flight), to provide a visual warning to the pilot.

MACHMETER ERRORS

The machmeter suffers from **instrument, position and manoeuvre induced errors only**. It does **not** suffer from temperature or density errors, as these errors cancel out. In addition since compressibility error depends on dynamic / static pressure, and the instrument is calibrated to this ratio, compressibility error is calibrated out.

Position Error

The instrument uses the same sources of Pitot and Static pressure as the ASI and therefore suffers from position error caused by disturbed airflow at the pitot head and / or static vent. At low Mach Numbers below, careful design and positioning of the pressure sources ensure that position error on modern jet aircraft is small. However, above at higher Mach Numbers, changes in airflow may cause position error to become bigger and possibly change its sign. If the sign of the position error is such that the machmeter under-reads, the error could become dangerous at high Mach numbers. The normal arrangement in modern jet transport aircraft is to allow for instrument and position error such that the machmeter **always over-reads**.

Manoeuvre Induced Error

The machmeter will suffer an additional, unpredictable error whenever the aeroplane manoeuvres. This is due to the unpredictable changes in the airflow over the static source.

BLOCKAGES

Static Source Blocked. If the static source is blocked the pressure in the Machmeter case will not alter when the aircraft climbs or descends.

If a blockage occurs in a **climb** the altitude capsule will not move. Assuming a constant IAS (and therefore a constant dynamic pressure) the airspeed capsule will contract as the static component of pitot pressure reduces. The Machmeter will therefore **under read**.

If a blockage occurs in a **descent** at a constant IAS, the airspeed capsule will expand due to the increasing static component of pitot pressure. The Machmeter will therefore **over read**.

Pitot Source Blocked. Assuming a climb or descent at a constant IAS (and therefore a constant dynamic pressure) the Machmeter will **over read in the climb** and **under read in the descent**. In the climb the airspeed capsule will expand in error because the static component of pitot in the capsule will be greater than the static in the case. In the descent the static component of pitot will be too small and therefore the airspeed capsule will contract.

Note: It may be noticed that the Machmeter blockage errors are the same as the ASI blockage errors.

ABBREVIATIONS

MMR machmeter reading, the uncorrected reading

IMN indicated Mach number, MMR corrected for instrument error (the values quoted in Flight Manuals are normally IMN)

TMN true Mach number, IMN corrected for position error M_{MO} . There is much less risk of an over-speed condition arising when this is available.

MACHMETER SUMMARY

Mach number = TAS / LSS.

Speed of sound is proportional to the square root of the absolute temperature, and therefore decreases with the decrease in temperature normally encountered with increase in altitude.

While climbing at a constant Mach number, TAS decreases and CAS decreases more rapidly, the LSS also decreases..

While climbing at a constant CAS, TAS and Mach number increase but the LSS decreases.

Remember that in calculations involving the **Jet Standard Atmosphere**, the temperature is assumed to be + 15°C at MSL with a lapse rate of 2° per 1000 with **no** upper limit (ie no tropopause).

CLIMB AT A CONSTANT CAS IN STANDARD (ISA) ATMOSPHERE

If we were to climb at 330 kt CAS from sea level to 36,000 ft in the standard atmosphere,

- TAS will increase from 330 kt to 593 kt, and
- Mach number will increase from 0.5 M to 1.05 M.

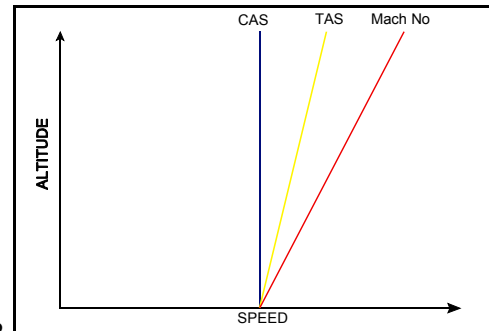

Figure 7.2

The rapid rise of Mach number (in this case far exceeding M_{CRIT}) is the reason why high performance aircraft are flown on CAS (or IAS) for the first part of the climb before transferring to a constant Mach number for the rest of the climb. Similarly in the descent at constant CAS, TAS and Mach number reduce, with Mach number reducing at a greater rate.

This is shown diagrammatically in Figure 7.2 For a constant CAS (blue line) as altitude increases, TAS (the yellow line) increases, and Mach number (the red line) increases at a greater rate. The navigation computer can also be used to show the relationship between CAS, TAS and Mach number but also gives us an idea of magnitude.

Now consider a descent at 0.8 M from 40,000 ft to sea level in the jet standard atmosphere on the navigation computer.

At 40,000 ft 0.8 M is 450 kt TAS, at sea level it has increased to 528 kt. The CAS has increased more markedly from 242 kt at 40,000 ft to 528 kt at mean sea level. This would exceed V_{NO} . Therefore although Mach number is used at altitude, CAS will be used in the descent.

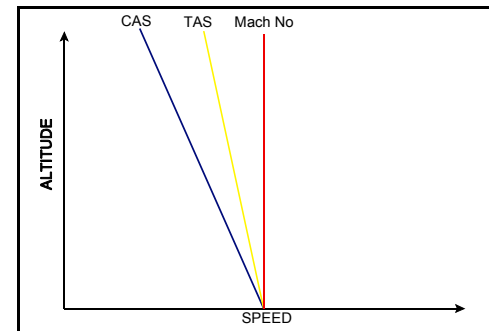

Figure 7.3

Note: You will have probably noticed by now that the relationship of CAS, TAS and Mach number as an aeroplane climbs or descends through the standard atmosphere remains the same. That is Figures 7.2. and 7.3. are the same - just tilted to one side or the other. Therefore when considering the climb/descent through an isothermal layer and an inversion only the constant TAS figure will be shown.

DESCENT AT A CONSTANT MACH NUMBER IN STANDARD CONDITIONS

During a descent in the ISA, the LSS will be increasing (as temperature increases). Therefore if Mach number is being kept constant the TAS must be increasing (Mach number = TAS / LSS) During the descent air density increases and if TAS is also increasing the CAS must also increase at a greater rate (Dynamic Pressure = $\frac{1}{2} \rho V^2$). This is shown in Figure 7.3. Similarly in a climb at constant Mach number the TAS or CAS both reduce.

CLIMB AND DESCENT THROUGH AN ISOTHERMAL LAYER

Constant Mach number

An isothermal layer is a layer of air in which the temperature does not change. Therefore the LSS will not change, and for a constant Mach number the TAS will not alter. The CAS will change however due to density error, reducing during the climb and increasing during a descent.

Constant CAS

Climbing at a constant CAS, the TAS and Mach number will both increase (at the same rate).

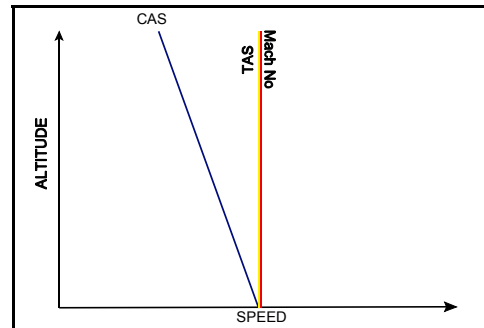

Figure 7.4

CLIMB AND DESCENT THROUGH AN INVERSION

Constant Mach number

In an inversion the temperature of the air will increase (get warmer) as altitude increases. Therefore in a climb the LSS will increase, and for a constant Mach number the TAS will increase

(Mach number = TAS/LSS).

CAS will reduce as air density reduces. Descending at a constant Mach number the TAS will reduce and the CAS will increase.

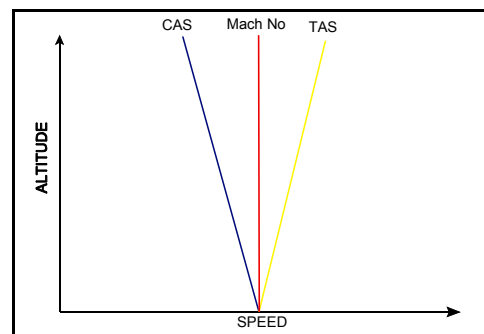

Figure 7.5

Constant CAS

Climbing at a constant CAS, the TAS and Mach number will both increase (TAS at a greater rate than Mach number).

CLIMB/DESCENT SUMMARY

In summary;

TAS will always increase when an aeroplane climbs at a constant CAS.

Climbing at a constant TAS the CAS will always reduce.

This is because pressure has a greater effect on air density than temperature.

Climbing at a constant CAS the Mach number will always increase.

Climbing at a constant Mach number the CAS will always reduce.

This is because the CAS/TAS density error dominates over the change in LSS due to temperature variation.

EXAMPLE PROBLEMS ASSOCIATED WITH THE MACHMETER

Problem 1: What is the speed of sound at FL 380 in ISA conditions?

Solution 1:

In the ISA atmosphere FL 380 is above the tropopause and therefore the temperature will be -56.5°C or 216.5°K

$$\begin{aligned} \text{LSS} &= 38.95 \sqrt{T} \\ &= 38.95 \sqrt{216.5} \\ &= \mathbf{573 \text{ knots}} \end{aligned}$$

These calculations can also be completed on the navigation computer. Place the Mach number index arrow against the temperature (in $^{\circ}\text{C}$), locate M1.0 (the blue 10 on the Navigation Computer) on the inner Mach number scale and read off the TAS on the outer scale.

Problem 2: Determine the TAS corresponding to 0.70 M at JSA MSL ($+15^{\circ}\text{C}$ or 288°K).

Solution 2:

Using the computer, set the Mach number index against $+15^{\circ}\text{C}$ in the Airspeed window. Against 7 (for 0.7 M) on the inner scale, read off the answer (463 knots) on the outer scale.

Alternatively calculate TAS from the formula

$$\begin{aligned} \text{TAS} &= \text{Mach number} \times \text{LSS} \\ &= 0.7 \times 38.95 \sqrt{288} \\ &= 0.7 \times 661 = \mathbf{463 \text{ knots}} \end{aligned}$$

Problem 3: Calculate without using a computer the altitude in the JSA atmosphere at which a TAS of 450 knots corresponds to Mach .80

Solution 3:

$$\text{Mach Number} = \frac{\text{TAS}}{\text{LSS}} \qquad \text{LSS} = \frac{\text{TAS}}{\text{MN}}$$

$$\text{LSS} = \frac{450}{.8} = 562.5 \text{ Kts}$$

$$\text{However, } \text{LSS} = 38.95 \sqrt{T} \qquad \sqrt{T} = \frac{\text{LSS}}{38.95} = \frac{562.5}{38.95} = 14.44$$

$$T = 14.44^2 = 209^{\circ}$$

T = 209° Absolute which is equal to -64°C

-64°C occurs at **FL395** in the JSA which has **no** tropopause.

Problem 4 If a decrease of 0.12 in the Mach Number results in a decrease of 80 Knots in the TAS, what is the local speed of sound.

Solution 4

$$\text{Mach Number} = \frac{\text{TAS}}{\text{LSS}} \qquad \text{LSS} = \frac{\text{TAS}}{\text{MN}}$$

$$\text{LSS} = \frac{80}{.12} = 667 \text{ Kts}$$

Problem 5 An aircraft is flying at FL360 with a Tas of 467 Knots at Mach No 0.8 when the temperature difference from JSA is +9. What is the Temperature difference at FL320 if Mach 0.8 still gives a TAS of 467 Knots.

Solution 5.

At FL360 in JSA temp would be - 57°C. JSA +9 would be - 48° C

However if Mach No and TAS remain the same, then we must be flying in an **Isothermal layer**, so the Temperature of - 48°C and the LSS would remain the **same**.

If the Temperature at FL320 is also - 48°, Temp Deviation from standard must be + 1° as JSA should be - 49°C.

MACH / AIRSPEED INDICATOR

Since many commercial aircraft require indications of both IAS and Mach number, it is sensible to combine both instruments. The basic principals of both instruments still apply.

Errors

The combined instrument will have the errors of both the Machmeter and the airspeed indicator, namely; instrument, position, manoeuvre induced, density and compressibility errors.

CONSTRUCTION

There are two types of Mach/Airspeed Indicator:

- A self contained instrument fed from Pitot and Static sources.
- A combined instrument fed from the Air Data Computer.

Note that:

- The airspeed pointer moves clockwise over a fixed scale.
- From 0.5 M the Mach number is read off the same pointer as it moves over a moving Mach number scale. This scale rotates anti-clockwise beneath the pointer as Mach number increases.
- A second striped needle may be present to mark V_{mo} .

If the aircraft is fitted with an Air Data Computer (ADC) it will measure Pitot pressure, Static pressure and Total Air Temperature and then electronically, send the information to any instruments and other computers which require it. The advantages related to the combined Mach / Airspeed instrument are;

- The ability to correct for instrument and position errors to give Rectified Airspeed (CAS) instead of ASIR.
- The use of a digital displays for both Mach number and CAS.

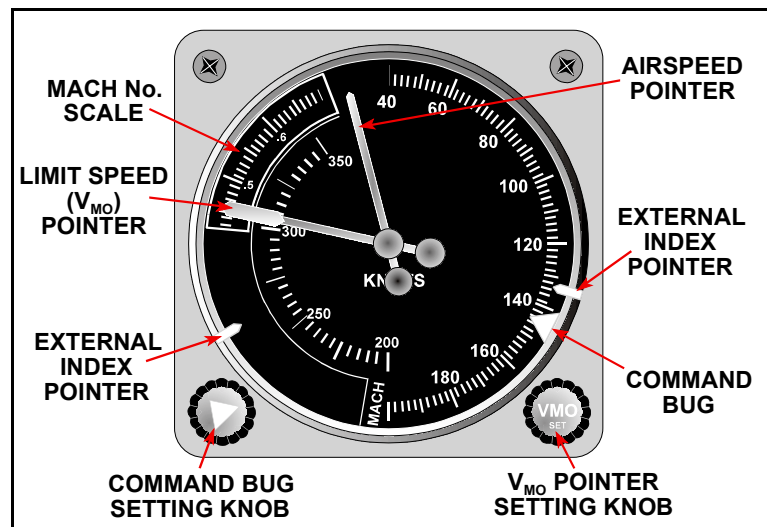

Figure 7.6 A Mach/Airspeed Indicator fed from Pitot and Static Sources

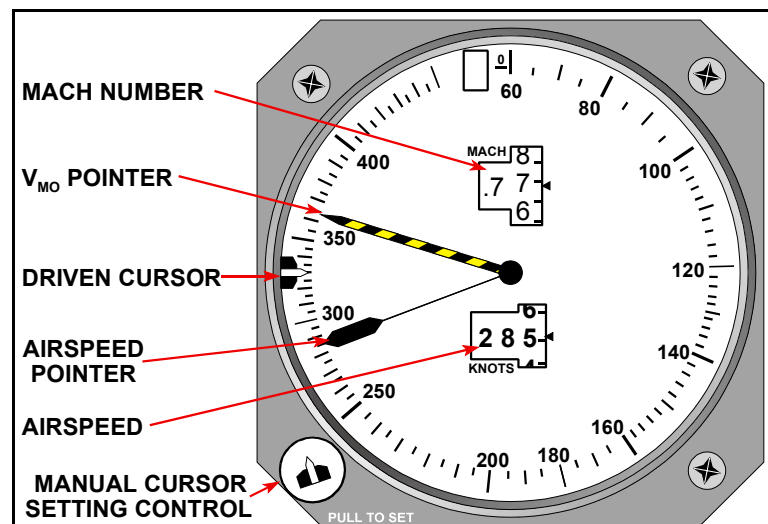

Figure 7.7 A Combined Instrument fed from the Air Data Computer

QUESTIONS

1. The local speed of sound is equal to:
(K = Constant)
 - a. $K \sqrt{\text{temperature } (^{\circ}\text{F})}$ knots
 - b. $K \sqrt{\text{temperature } (^{\circ}\text{K})}$ knots
 - c. $K \sqrt{\text{temperature } (^{\circ}\text{C})}$ knots
 - d. $K \sqrt{\text{temperature } (^{\circ}\text{K})}$ metres per second.

2. At FL 350 with a JSA deviation of -12, the true airspeed when flying at M 0.78 is:
 - a. 460 kt
 - b. 436 kt
 - c. 447 kt
 - d. 490 kt

3. Below is a schematic diagram of a Machmeter. Parts A, B, C and D are:
 - a. ratio arm, mach no pointer, static pressure inlet, ranging arm.
 - b. ranging arm, limiting mach no index, static pressure inlet, ratio arm.
 - c. main shaft, TAS index, pitot pressure inlet, ranging arm.
 - d. ranging arm, limiting mach no index, pitot inlet, main shaft.

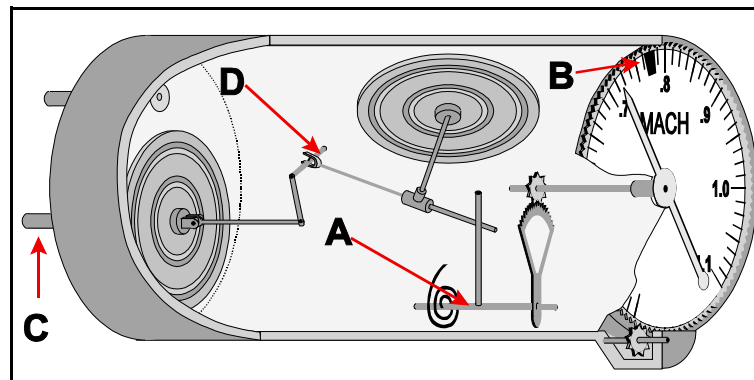

4. When climbing at a constant mach number below the tropopause through an inversion:
 - a. the CAS and TAS will both increase.
 - b. the CAS and TAS will both decrease.
 - c. the CAS will decrease and the TAS will increase.
 - d. the CAS will increase and the TAS will decrease.

5. When descending below the tropopause under normal conditions (increasing temperature) at a constant CAS:
 - a. both TAS and mach number will decrease.
 - b. both TAS and mach number will increase.
 - c. the TAS will decrease and the mach number will increase.
 - d. the TAS will increase and the mach number will decrease.

6. Cruising at FL390, M 0.84 is found to give a TAS of 499 kt. The ISA deviation at this level will be:
- 17
 - +17
 - +19
 - 19
7. The errors to which the machmeter is subject are:
- instrument error, position error, compressibility error and manoeuvre induced error.
 - instrument error, position error and manoeuvre induced error.
 - instrument error, position error, barometric error, temperature error and manoeuvre induced error.
 - instrument error, position error, density error and manoeuvre induced error.
8. The relationships between TAS, mach number (MNo) and local speed of sound (LSS) is:
- $$\text{LSS} = \frac{\text{MNo}}{\text{TAS}}$$
 - $$\text{MNo} = \frac{\text{LSS}}{\text{TAS}}$$
 - $$\text{TAS} = \text{MNo} \times \text{LSS}$$
 - $$\text{MNo} = \text{LSS} \times \text{TAS}$$
9. The machmeter gives an indication of mach number by measuring the ratio:
- $$\frac{\text{pitot pressure}}{\text{static pressure}}$$
 - $$\frac{\text{static pressure}}{\text{dynamic pressure}}$$
 - $$\frac{\text{dynamic pressure}}{\text{pitot pressure}}$$
 - $$\frac{\text{dynamic pressure}}{\text{static pressure}}$$
10. An aircraft is flying at FL350 with a JSA deviation of +8. The mach no is 0.83 and the TAS 485. If the aircraft descends to FL300 and maintains the same mach no and TAS, the JSA deviation will now be:
- +8
 - 2
 - +2
 - 18

ANSWERS

- | | |
|----|---|
| 1 | B |
| 2 | B |
| 3 | D |
| 4 | C |
| 5 | A |
| 6 | B |
| 7 | B |
| 8 | C |
| 9 | D |
| 10 | B |

CHAPTER EIGHT
TERRESTRIAL MAGNETISM

Contents

THE MAGNET101

MAGNETIC FIELD101

POLES OF A MAGNET101

RED AND BLUE POLES.102

ATTRACTION AND REPULSION RULES102

METHODS OF MAGNETISATION103

METHODS OF DEMAGNETISATION104

MAGNETIC AND NON-MAGNETIC MATERIALS.104

HARD IRON AND SOFT IRON105

TERRESTRIAL MAGNETISM106

MAGNETIC VARIATION.106

MAGNETIC DIP107

FIELD STRENGTH.107

DIRECTIVE FORCE108

REGULAR CHANGES IN EARTH MAGNETISM.109

UNPREDICTABLE CHANGES IN EARTH MAGNETISM109

DEFINITIONS109

QUESTIONS110

ANSWERS112

THE MAGNET

For thousands of years the oxide of iron called magnetite has been observed to attract small pieces of iron. This property is known as 'magnetism'.

Another property for which magnetite was known was its North-seeking capability; if mounted on wood and floated in water it would swing round and align itself in a roughly North-South direction, so acting as a primitive compass. In more recent history it was found that some metallic elements and alloys (mainly 'ferrous' - iron and steel) could be given these properties, bars of such magnetised material being known as 'magnets'.

MAGNETIC FIELD

The field of a magnet is the space around it in which its magnetic influence is felt. This may be illustrated by placing a piece of card over a bar magnet and scattering iron filings on it. When the card is shaken or tapped the filings will take up the field pattern as shown in Figure 8.1.

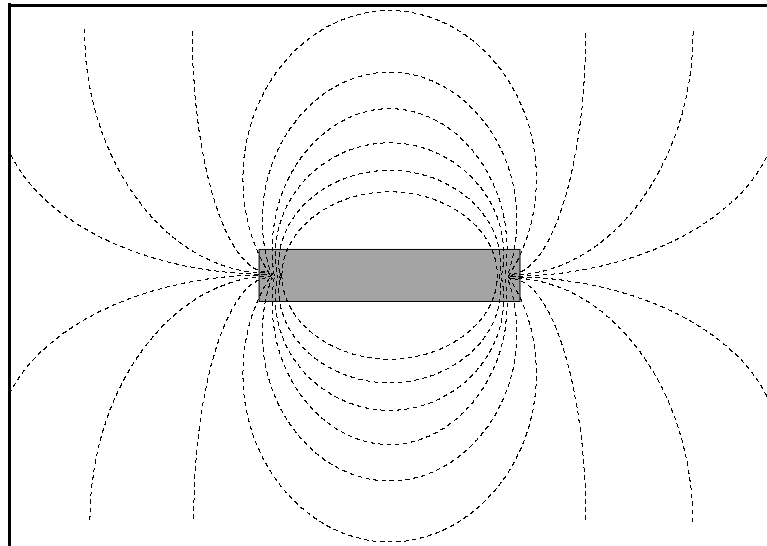

Figure 8.1 The Pattern of the Magnetic Field

POLES OF A MAGNET

From Figure 8.1. it can be seen that the 'lines of force' traced by the iron filings converge towards small areas near the ends of the magnet.

These two areas are called the 'poles' of the magnet and are where the properties of magnetism are most strongly displayed. Magnets are made in various shapes but each magnet always has two poles.

A unit pole cannot exist. If a magnet is cut into two pieces, each piece will have two poles.

RED AND BLUE POLES

A freely suspended bar magnet (or compass needle) in the earth's magnetic field will align itself roughly North-South.

The end which points North is known as a North-seeking or **red** pole. The other end is a South-seeking or **blue** pole.

By convention, magnetic lines of force are directed out from the red pole and back in to the blue pole as shown in Figure 8.2.

Again referring to Figure 8.2, for convenience the magnet has been divided into two halves, one half containing the red pole, the other half containing the blue pole.

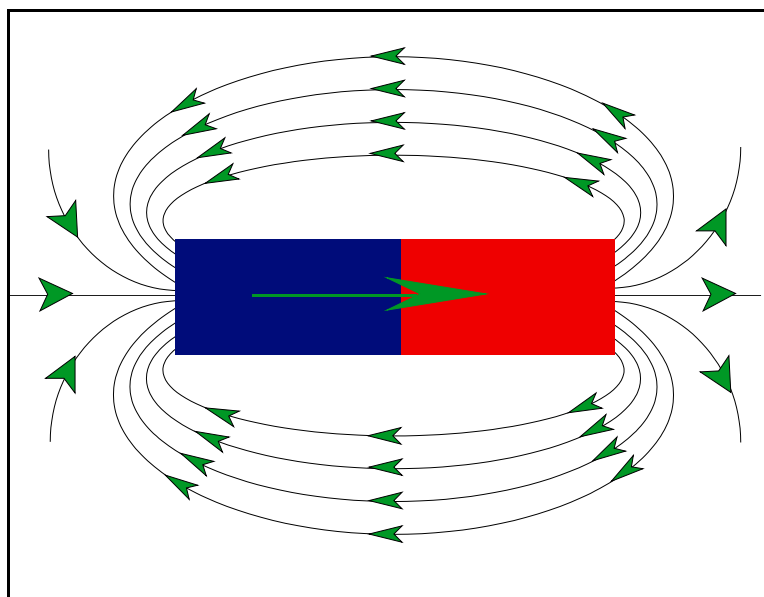

Figure 8.2 The Red and Blue Poles

ATTRACTION AND REPULSION RULES

If two bar magnets are placed in a line, end to end, so that the blue pole of one faces the blue pole of the other, a repulsion can be felt. If both magnets are turned around, so that red pole is close to red pole, then again the ends try to move apart. If, on the other hand, the blue pole of one magnet is placed close to the red pole of the other, an attraction is felt.

The rule is:

Like poles repel each other

Unlike poles attract each other

METHODS OF MAGNETISATION

Magnetism may be induced in an unmagnetised bar of iron by one of the following methods:-

- By stroking the bar repeatedly in the same direction with one end of a magnet, a process in which the end of the bar last touched by the red end of the magnet is left as a blue pole. Figure 8.3. depicts the process and shows the resulting polarity of the iron bar.

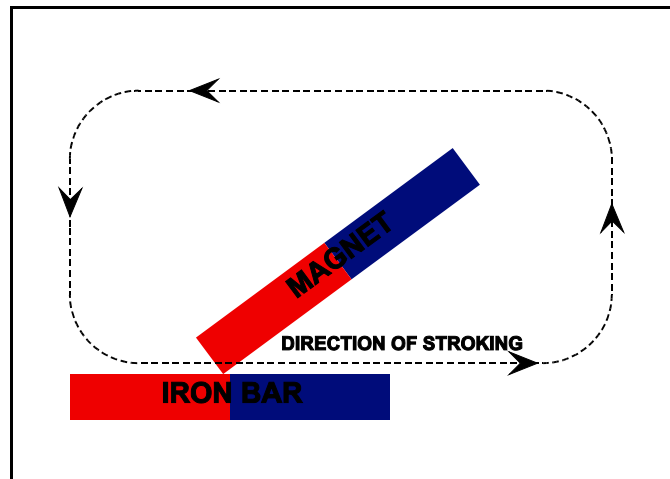

Figure 8.3 Making a Magnet by Stroking

- By aligning the iron bar with the lines of force of a magnetic field and subjecting it to vibration or hammering. Such agitation during manufacture (in the earth's magnetic field) is the main cause of aircraft magnetism. Figure 8.4. shows the polarity of the induced magnetism in the iron bar; it is such that there is continuity in the pattern of lines of force, as usual directed **in** to a blue pole, **out** from a red pole. The example is analogous to an aircraft being manufactured on a Northerly heading in the earth's field and acquiring a permanent red pole in the nose and blue pole in the tail.
- In the case of iron simply by subjecting to a magnetic field. The induced polarity is shown in Figure 8.4.

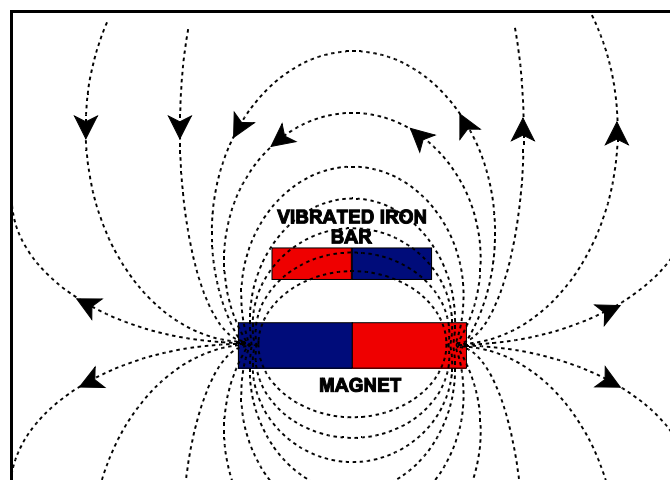

Figure 8.4 Making a Magnet by Vibrating or Hammering

- By placing the specimen within a solenoid (a cylindrical coil of wire) carrying a Direct Current. This is the most satisfactory method as the current flowing in the coil produces a concentrated magnetic field along the axis of the coil so that a high degree of magnetism can be induced in the iron. (Note that the amount of magnetism which can be induced is not unlimited because, at a certain level, the iron becomes magnetically 'saturated'). Figure 8.5. shows the polarity of the magnetism induced in the bar inside the solenoid. (If the current flow were reversed the induced magnetic polarity would be reversed).

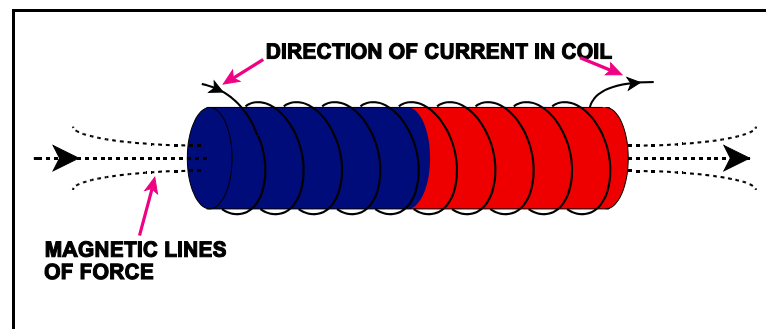

Figure 8.5 Magnetisation by Solenoid

METHODS OF DEMAGNETISATION

Three ways of removing most or all of the magnetism from a magnetised item are listed below.

- **Shock.** A magnetised bar of iron can be placed at **right angles** to the earth's magnetic field and hammered.
- **Heat.** If the specimen is heated to about 900°C, it loses its magnetism and this does not return as the specimen cools.
- **Electric Current.** The component is placed inside a solenoid carrying alternating current, the amplitude of which is gradually reduced to zero. The strong alternating magnetic field produced by the alternating current keeps reversing the direction of magnetisation (that is the **polarity** of the magnetism) in the specimen.

Not only is the polarity being reversed, but the intensity of magnetisation is being reduced as the current is reduced. The specimen's magnetism is very quickly reduced to zero or very nearly zero.

MAGNETIC AND NON-MAGNETIC MATERIALS

Magnetic materials are 'ferrous' metals iron and steel, steel being iron alloyed with substances such as carbon, cobalt, nickel, chromium, and tungsten. These metals are called 'ferromagnetic' and in an aircraft they may be magnetised and produce deviation in the aircraft's compasses.

Many materials used in aircraft construction are non-magnetic and do not affect the compass.

Examples of such non-ferrous substances are aluminium, duralumin, brass, copper, plastic, and paint.

HARD IRON AND SOFT IRON

Ferromagnetic material can be broadly divided into two classes, **hard iron** and **soft iron**. The words hard and soft do not refer to the physical properties of the material but to their magnetic characteristics.

A strong magnetising field is required to produce magnetic saturation in hard iron.

Hard iron magnetism is said to be ‘permanent’, meaning that the material, typically steel containing cobalt or chromium, remains magnetised for an indefinite period after it has been removed from the magnetising field.

Such a substance is suitable for permanent magnets. Soft iron magnetism is called ‘temporary’ (or ‘transient’ or ‘induced’) the substance being easy to saturate magnetically with only a weak magnetising field but retaining little or no magnetism when the field is removed. Nearly pure iron behaves in this way.

Some materials exhibit magnetic characteristics which lie somewhere between those of hard iron and soft iron. These substances can be magnetised but this ‘sub-permanent’ magnetism is lost partly or wholly over a period of time.

DESCRIPTION	METAL	EASE OF MAGNETISM	RETENTION OF MAGNETISM
HARD IRON	COBALT AND TUNGSTEN STEEL	HARD	CONSIDERABLE LENGTH OF TIME
SOFT IRON	SILICON IRON PURE IRON	EASY	PRACTICALLY NIL

TERRESTRIAL MAGNETISM

The earth behaves as though a huge permanent magnet were situated near the centre producing a magnetic field over the surface.

Figure 8.6. shows that the poles of this hypothetical earth-magnet do not lie on the earth's spin axis, this lack of symmetry giving rise to magnetic variation. The earth's blue pole lies at present beneath Northern Canada in the area around 70°N 95° W, the red pole being below Antarctica at about 72° S.

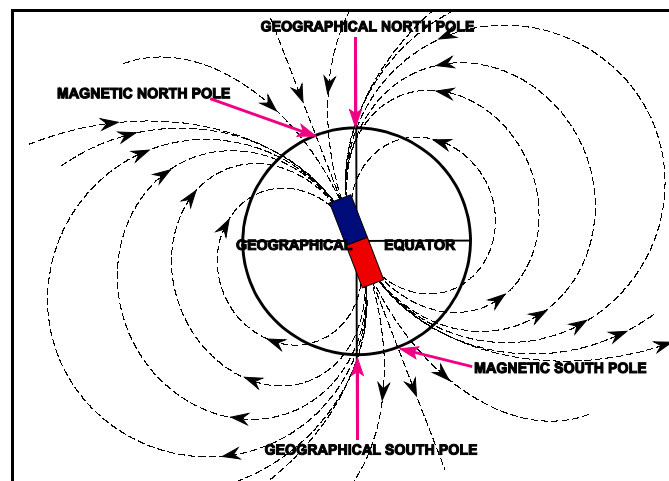

Figure 8.6 Earth's Magnetism

MAGNETIC VARIATION

The direction of the earth's field at any given point can be indicated by a freely-suspended magnet. Such a magnet will align itself roughly in a North-South direction with its red pole towards the North magnetic pole.

The longitudinal axis of the magnet defines the direction of the magnet meridian at the point.

The **magnetic meridian** is the direction of the horizontal component of the earth's field at a point on the earth's surface.

The angle, measured in the horizontal plane, between the magnetic meridian at a point and the true meridian at the point is known as the magnetic **variation**.

Variation is designated West or East depending on whether the magnetic pole lies to the West or to the East of true North.

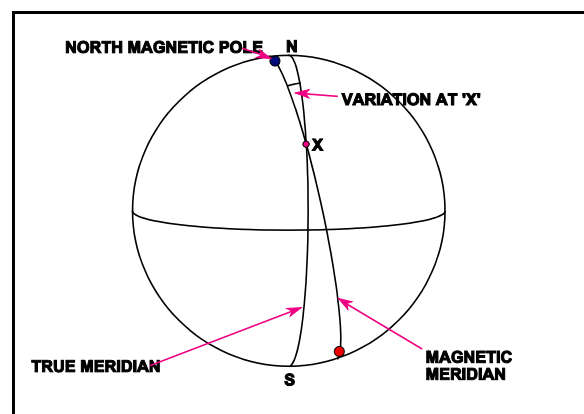

Figure 8.7 Magnetic Variation

Variation can have any value from zero to 180°, the latter occurring on the true meridian linking North geographical with North magnetic pole, similarly in the Southern hemisphere.

MAGNETIC DIP

Except near the 'magnetic equator', where the lines of force are parallel to the surface, one end of the freely-suspended magnet will dip below the horizontal, pointing to the nearer pole.

To the North of the magnetic equator, the magnet's red pole will be lower whereas to the South the blue pole will be lower. The angle, measured in the vertical plane, between the axis of the magnet and the horizontal is called the **angle of dip**.

Fairly closely following the geographical equator (in the main 10° of latitude of it) is the 'magnetic equator', which can be represented on a chart by a line joining points on the earth where the angle of dip is zero.

If the freely-suspended magnet is moved either North or South of the magnetic equator the dip gradually increases, reaching about 66° in the United Kingdom. Over the earth's magnetic poles the dip is 90° and the magnet is then vertical.

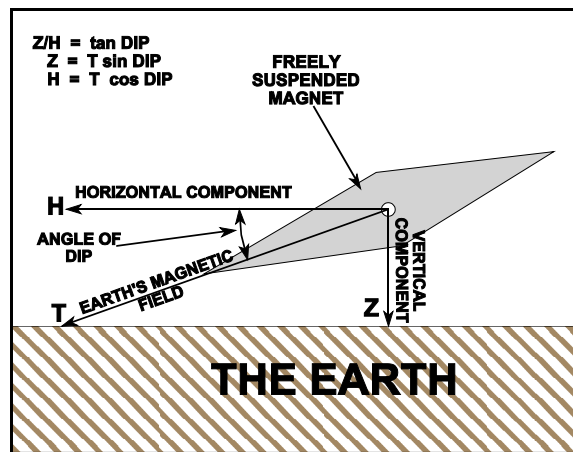

Figure 8.8 Resolution of the Earth's Field

FIELD STRENGTH

The total force T exerted at a point by the earth's field acts in the direction taken up by a freely-suspended magnet influenced **only** by the earth's field. The total force, angle of dip, and magnetic variation at a point are sometimes known as the 'magnetic elements' for that place. It is convenient to resolve this total force T into its horizontal and vertical components H and Z respectively. Figure 8.8. demonstrates this resolution.

DIRECTIVE FORCE

The horizontal component H of the earth's field is known as the **directive force** because it is the component which aligns the magnetic compass needle with the magnetic meridian, so providing a directional reference. When either of the earth's magnetic poles is approached, this component approaches zero strength, while the value of Z approaches that of T . Over the pole, with dip 90° and zero directive force H , the magnetic sensor (compass) becomes useless.

In the region of the magnetic equator the strength of the directive force H approaches the value of T , while Z approaches zero as does the angle of dip.

It becomes apparent that the directive force H decreases as the angle of dip increases, and vice versa and Figure 8.9. serves to illustrate this.

In fact, the relationship between H and dip angle is not quite as simple as it appears, because of irregularities in the pattern of the earth's field and variations with position and time of the total magnetic force T .

The strength of the horizontal component H at a latitude about 60°N of the magnetic equator is very roughly half the value of H at the magnetic equator.

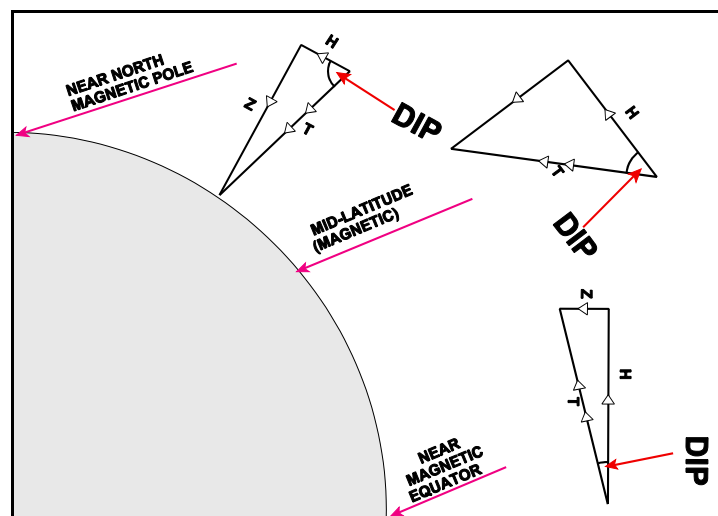

Figure 8.9 The Effect of Latitude on the Components of Dip

REGULAR CHANGES IN EARTH MAGNETISM

Secular Change. The earth's field not only lacks symmetry but is also subject to several known periodic changes.

Of these, the **secular** changes are the most significant and are produced by the slow movement of the magnetic poles about the geographic poles, the period of this cycle being apparently about 960 years.

The North magnetic pole is moving slowly westward, this wander mainly affecting magnetic variation.

In the UK the value of Westerly variation is currently decreasing at a rate of 7 minutes per annum, and the predicted variation in London in the year 2240 is zero.

The annual rate of change of variation is shown on navigation charts so that the variation printed against the isogonals can be readily up-dated.

Other regular changes occur diurnally, annually, and over an eleven-year period, this latter cycle apparently being related to the eleven-year cycle of sunspot activity. These changes, unlike the secular type mentioned earlier, are not of sufficient magnitude to affect normal navigation.

UNPREDICTABLE CHANGES IN EARTH MAGNETISM

Magnetic 'storms' of varying intensity and lasting for as long as three days occur at irregular intervals. These phenomena appear to be produced by unusually large sunspots.

The main effect of these magnetic storms is a temporary but significant change in magnetic variation. The alteration is unlikely to exceed 2° in the UK but in the Arctic and Antarctic the change may exceed 5° and last for as long as an hour. The value of the directive force H can also change and in high latitudes may fall below the minimum required for efficient compass operation.

DEFINITIONS

Isogonals are dotted (pecked) lines on a map or chart joining places of equal magnetic variation.

An Agonic Line is an isogonal joining places of zero magnetic variation.

Isoclinals are lines on a map or chart joining places of equal magnetic dip.

An Aclinic Line is an isoclinical joining places of zero magnetic dip, and is the Earth's Magnetic Equator.

QUESTIONS

- The red pole of a freely suspended magnet will point towards and at latitude 60°N will point at an angle known as the angle of
 - the nose of the aircraft, downwards, deviation.
 - the north magnetic pole, downwards, variation.
 - the nearest pole, downwards, declination.
 - the north magnetic pole, downwards, dip.
- If the total force of the earth's field at a point is T and the horizontal and vertical components H and Z , the value of H is found by the formula:
 - $H = T \sin \text{dip}$
 - $H = Z \tan \text{dip}$
 - $H = T \cos \text{dip}$
 - $H = T \tan \text{dip}$
- In the diagram below, the compass heading of the aircraft is, the magnetic heading and the true heading

- 025° 015° 020°
- 335° 035° 020°
- 335° 340° 035°
- 025° 015° 340°

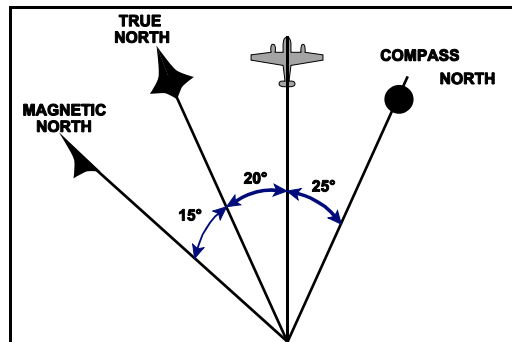

- The directive force of the earth's magnetic field:
 - varies with the heading of the aircraft.
 - increases as the magnetic variation increases.
 - increases as magnetic latitude increases.
 - is greatest at the magnetic equator.
- The slow change in the earth's magnetic variation is known as the change and is caused by
 - annual, westerly movement of the magnetic pole.
 - diurnal, easterly movement of the magnetic pole.
 - secular, westerly movement of the magnetic pole.
 - annual, sunspot activity.
- Soft iron is comparatively to magnetise whilst hard iron is to demagnetise.
 - easy; difficult.
 - easy; easy.
 - difficult; easy.
 - difficult; difficult.
- Which of the following materials are classed as ferromagnetic:

- a. iron, steel, carbon-fibre.
 - b. nickel, iron, steel.
 - c. copper, iron, carbon steel.
 - d. iron, cobalt steel, chromium steel.
8. The magnetic moment of a magnet:
- a. is the product of pole strength and effective length.
 - b. varies inversely as the square of the distance between the poles.
 - c. varies directly as the square of the distance between the poles.
 - d. decreases as the magnet length increases.

ANSWERS

- | | |
|---|---|
| 1 | D |
| 2 | C |
| 3 | B |
| 4 | D |
| 5 | C |
| 6 | A |
| 7 | D |
| 8 | A |

CHAPTER NINE

THE DIRECT INDICATING COMPASS

Contents

THE MAGNETIC COMPASS115

DIRECT INDICATING MAGNETIC COMPASS115

THE VERTICAL CARD COMPASS116

THE GRID RING COMPASS116

COMPASS REQUIREMENTS.117

HORIZONTALITY.117

SENSITIVITY118

APERIODICITY118

THE COMPASS LIQUID118

SERVICEABILITY CHECKS119

DAMPING AND PIVOT FRICTION TESTS119

DEVIATION120

ACCELERATION AND TURNING ERRORS.120

ERRORS CAUSED BY LINEAR ACCELERATION.121

SUMMARY OF ACCELERATION ERRORS124

TURNING ERRORS124

TURNING ERRORS - LIQUID SWIRL.128

SUMMARY OF TURNING ERRORS.128

QUESTIONS130

ANSWERS132

THE MAGNETIC COMPASS

A compass is an instrument designed to indicate direction on the surface of the earth, relative to some known datum. The magnetic compass uses the horizontal component of the earth's field as its directional datum. Unfortunately, the earth's field is normally not aligned with the true meridian - the most desirable datum from which to measure direction. The angular difference between true and magnetic meridians is called the **magnetic variation** discussed in the previous chapter.

The purpose of a magnetic 'steering' compass in an aircraft is to indicate heading, the direction in which the aircraft is pointing.

Magnetic influences - iron/steel components, electric currents - distort the earth's field so that the compass magnet assembly deviates from the magnetic meridian. This is called **compass deviation**.

The rules for applying variation and deviation to the compass heading indication in order to determine true heading are detailed in the Navigation notes.

DIRECT INDICATING MAGNETIC COMPASS

This chapter deals with the direct indicating or direct reading magnetic compass, where the pilot directly reads his heading in relation to the pivoted magnet assembly.

There are two basic types of direct reading magnetic compasses used in aircraft, **the vertical card** and, less commonly, **the grid ring compass**.

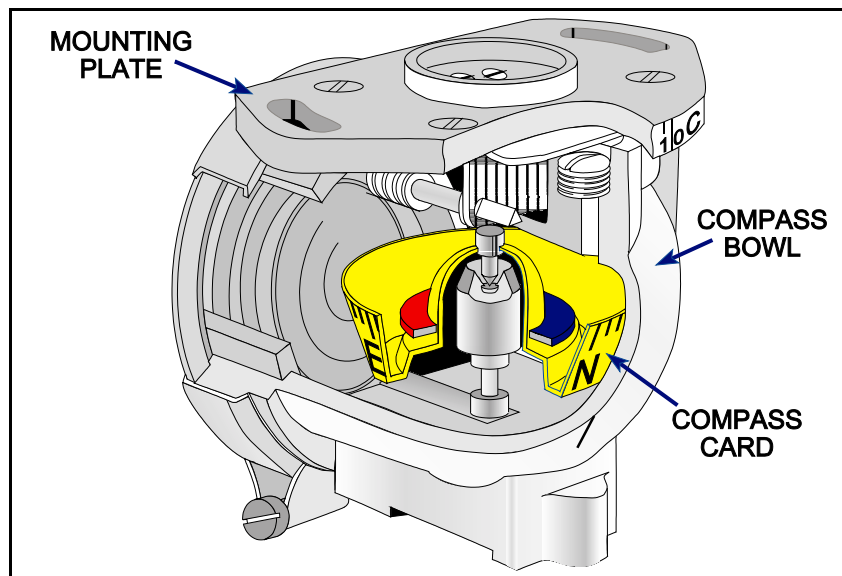

Figure 9.1 A Vertical Card Compass

THE VERTICAL CARD COMPASS

The vertical card compass - which is also known as the B-type or E-type - is the direct reading compass in general use. It is usually the main magnetic heading reference in light aircraft and the standby compass in larger aircraft.

It consists of a circular compass card attached directly to the magnet assembly. This combined unit is suspended in liquid within the compass bowl. A vertical lubber line on the glass window of the bowl, enables the heading to be read off the compass card.

THE GRID RING COMPASS

The P-type compass or grid ring compass is found on older aircraft. It is more accurate than the vertical card compass and is more stable.

It is however heavier, bulkier and more expensive. In addition it can only be read in straight and level flight, as the grid ring has to be unclamped and aligned with the north reference before a reading can be taken against the lubber line.

The grid ring compass also differs from the vertical card compass in that it achieves a greater periodicity by the addition of **damping wires** which also rotate through the compass liquid.

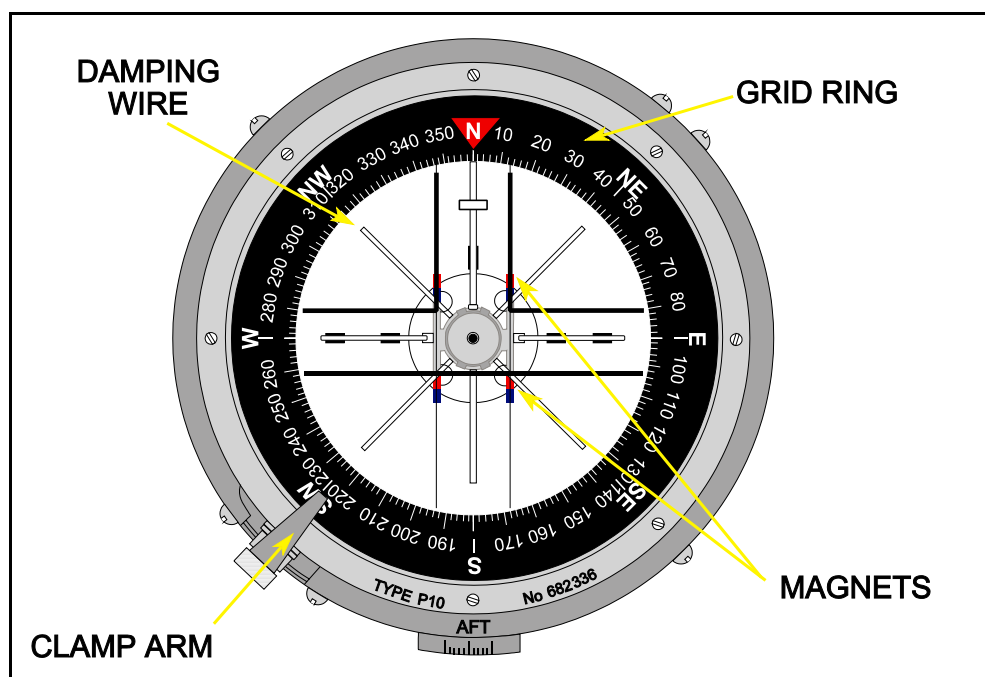

Figure 9.2 A Grid Ring Compass

COMPASS REQUIREMENTS

The direct reading magnetic compass contains a pivoted magnet which must be able to align itself, and remain aligned, with the horizontal component of the earth's magnetic field. For the compass to succeed, certain requirements must be satisfied. The most important of these are that the magnet system must be:

- **Horizontal**
- **Sensitive**
- **Aperiodic**

HORIZONTALITY

In order to measure direction in the horizontal, the magnets must lie as nearly as possible in the horizontal plane during normal straight and level flight. A freely suspended magnet assembly would align itself with the earth's total field so the magnets would only be horizontal at the magnetic equator.

To achieve horizontality, the magnet assembly is '**pendulously suspended**', the centre of gravity of this assembly being lower than its supporting pivot, as shown in Figure 9.3.

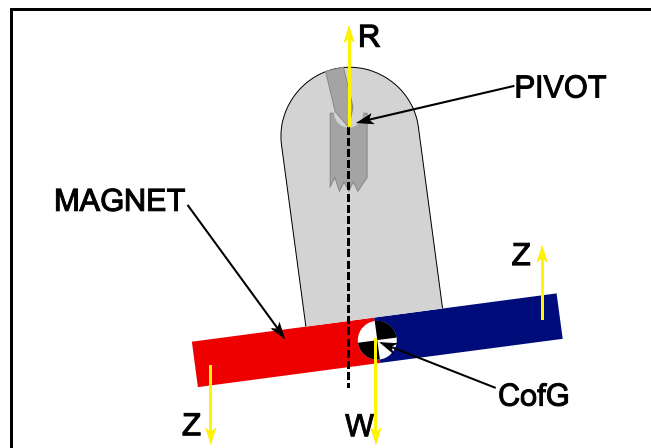

Figure 9.3 Equilibrium (Northern Hemisphere) Viewed From West

In this way, the tilting effect caused by the vertical component Z of the earth's field is opposed by the weight of the magnet assembly, this equilibrium being achieved at the cost of only a very slight residual tilt of the magnets (North-seeking ends down) - by about 2° in mid-latitudes - in the Northern hemisphere. (South-seeking end down in the Southern hemisphere). Figure 9.3. shows the two turning couples involved.

One is produced by Z which exerts a downward force on the red (North-seeking) end of the compass magnet and an upward force on the blue end.

The other couple is produced by the weight W acting downwards through the centre of gravity (displaced because of the tilt) and the reaction R acting upwards through the pivot.

For equilibrium, the magnet takes up the amount of tilt necessary to make the couples balance. (A third - very weak - couple produced by the horizontal component, H , of the earth's field, opposing the tilt has been omitted for simplicity).

SENSITIVITY

The magnet system is required to seek the horizontal component H of the earth's field in all areas except near the magnetic poles - where the horizontal component is inadequate.

The notes on magnetism show that the ability of a pivoted magnet to align itself with an external field - its sensitivity - depends on the strength of the external field and on the magnetic moment of the magnet. The weak external field (H) at a place cannot be changed, but the magnetic moment of the magnet can be increased - by increasing the magnet's length and/or pole strength.

It is however undesirable to increase the magnet length so the pole strength is increased by using **two, four or six short magnets** or a circular magnet, made of an alloy which will accept and retain the high degree of magnetism required.

Sensitivity is further increased by reducing friction. This is achieved in three ways:

- By using an **iridium-tipped pivot** in a **jewelled cup**
- By **lubricating the pivot** with the liquid which fills the compass bowl.
- By reducing the **effective weight** of the magnet assembly acting down through the pivot, because the liquid that the magnet assembly is displacing is denser than air .

APERIODICITY

The magnetic assembly is required to be aperiodic or '**dead beat**', which means that it should settle down quickly on a steady indication after being displaced by turbulence or manoeuvres.

Any tendency to oscillate must be quickly 'damped out'. The desired aperiodicity is achieved as follows:

- **Several short magnets** are used instead of one longer one. This keeps the mass of the assembly near the centre, so reducing the moment of inertia and consequently making any oscillations easier to damp out. Light alloy is utilised wherever possible in order to minimise the weight of the assembly framework.
- The primary purpose of the liquid in the compass bowl is to act as a **damping liquid** on the compass assembly. The grid ring compass dampens oscillations more rapidly than the vertical card compass, due to addition of **damping wires**. These wires are attached to the magnet assembly and also pass through the damping liquid. (See Figure 9.2.)

THE COMPASS LIQUID

The liquid mentioned earlier is essential to the design of the compass. Two difficulties may arise. Firstly, the liquid is likely to expand or contract with change of temperature; this is overcome by incorporating an expansion chamber or 'Sylphon tube'.

Secondly, errors occur in sustained turns as a result of 'liquid swirl'. Liquid swirl occurs due to the viscosity of the liquid, because of this the liquid chosen should have a low viscosity to minimise liquid swirl. Liquid swirl is discussed later in this chapter.

Various liquids, including alcohol have been used. The main properties required of a compass liquid are:

- Low coefficient of expansion
- Low viscosity
- Transparency
- Low freezing point
- High boiling point
- Non-corrosiveness

SERVICEABILITY CHECKS

Compass body. Check that there is no obvious damage such as dents or cracks. Any lighting system should be checked, as should the efficacy of the luminous paint.

Compass Liquid. The compass liquid should be checked and be free from:

- Sediment and discolouration - either of which would indicate corrosion which would result in increased pivot friction.
- Bubbles - which would probably indicate a leaking seal. Turbulence and manoeuvres would cause any bubbles to move about, creating eddies which could disturb the magnet system.

Accuracy Limit - JAR: $\pm 10^\circ$

DAMPING AND PIVOT FRICTION TESTS

These tests are carried out before a compass is installed or swung, and whenever the accuracy of the instrument is suspect. The exact values quoted in the tests vary with the type, make and mark of compass. Furthermore, the figures are for a specified standard value of the earth's directive force H. If the tests are to be conducted at latitudes where the value of H is significantly different, there may be a need to modify these figures.

Damping Test

This is also known as a 'swing' test designed to check that, after displacement, the magnet assembly returns quickly and without appreciable oscillation to its North alignment.

Using a small magnet, deflect the compass by 90° , holding this deflection for at least 20 seconds to allow the liquid to come to rest. Remove the deflecting magnet; the time taken to swing back through 85° should be 2 to 3 seconds for a standby compass.

Pivot Friction Test

Using a small magnet, deflect the compass by 10° and hold it in this position for at least 10 seconds. Remove the magnet and note the reading when the compass settles. Repeat the procedure, deflecting 10° in the opposite direction, and note the reading when the compass settles again

The two readings should agree within $2\frac{1}{2}^\circ$ for a standby compass. It is usual to carry out this test on four headings 90° apart.

DEVIATION

Deviation is produced by the iron/steel components in the aircraft. It is the angle between the local magnetic meridian and the direction in which the compass magnets are lying.

Deviation is named Easterly (or plus) if the North-seeking (red) ends of the magnets point to the East of magnetic North. If the North-seeking ends point to the West of magnetic North, deviation is said to be Westerly (or minus).

Deviation varies with heading so it has to be measured on a series of different headings. This is usually done by conducting a **compass swing** (which is fully covered in the chapter on aircraft magnetism). Once deviation has been reduced as far as possible, the residual deviation is recorded on a compass deviation card, which is located in the aircraft.

During the swing, normal flying conditions should be simulated as far as possible, with engines running, electrical / radio services switched on, and the aircraft in a level flight attitude.

It is obviously most important that no ferromagnetic objects such as tools, or watches should be placed near the compass as this would introduce unknown amounts of deviation. Furthermore, ferromagnetic payloads should be stowed as far away from the compass as permissible within the loading limits. With exceptionally large ferromagnetic loads, a compass swing may have to be carried out before flight with the load aboard.

ACCELERATION AND TURNING ERRORS

Direct reading compasses are subject to large errors during linear acceleration or deceleration, or during a turn.

Most manoeuvres which cause the centre of gravity of the magnet assembly to move away from its normal position, almost directly below the pivot, will produce an error.

However, if the manoeuvre displaces the centre of gravity North or South of its usual position so that cg and pivot are still in the plane of the magnetic meridian, the magnet assembly merely changes its North-South tilt angle, with no rotation in azimuth and consequently no error.

Note also that turning and acceleration errors only occur where there is a significant vertical component (Z) in the earth's field, so that except for a small liquid swirl effect in turns, the errors are non-existent near the magnetic equator.

The north seeking end of the compass magnet should remain pointing in the same direction - Magnetic north- whether the aircraft is moving in a straight line or turning.

Acceleration and turning errors occur however when the north seeking end of the magnet is displaced from Magnetic north and therefore an incorrect heading will be shown on the compass card which is attached to the magnet. Figure 9.4 shows a pendulously suspended magnet (with residual dip) in the northern hemisphere.

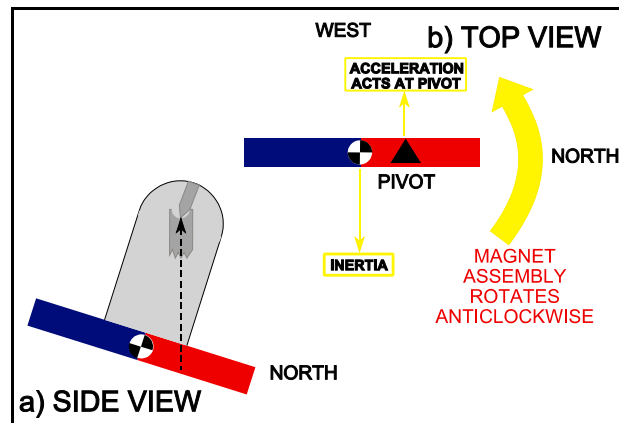

Figure 9.4 A Pendulously Suspended Magnet in the Northern Hemisphere

Note that the vertical line through the pivot point is now closer to the nearer (north) magnetic pole than the magnet's centre of gravity. Consider an aircraft, (and therefore the magnet assembly) being accelerated towards the west, as shown in Figure 9.4b. The magnet is attached to the aircraft at the pivot point. However while the pivot is being accelerated the magnet's inertia, which acts at the magnet's centre of gravity, will try to maintain its state of uniform motion. The result will be that the magnet will rotate (in this case anticlockwise) and the incorrect heading will be shown.

ERRORS CAUSED BY LINEAR ACCELERATION

The size of the acceleration error depends on a number of factors which includes aircraft heading. Acceleration / deceleration errors are **maximum** on **East** and **West** (M) headings and **zero** on **North** and **South** (M) headings.

The error is caused by inertia acting on a magnet which has residual dip due to the effect of the vertical component Z on the magnet.

Acceleration on 270°M (NH)

Figure 9.5 shows an aircraft accelerating on a magnetic heading of 270°M in the Northern hemisphere, such as occurs during take-off on runway 27. Since the magnet assembly is pendulously suspended, its inertia will cause it to swing back behind the pivot point which is offset to the north of the magnet's centre of gravity. This displacement enables a turning couple produced by the earth's vertical component Z to rotate the magnet assembly **anticlockwise** round the pivot.

The angle measured clockwise from the North-seeking end round to the aircraft's nose increases. The compass reading will therefore **increase**, so indicating an **apparent turn towards North**. Thus, according to the compass, the aircraft is now heading, say, 280° whereas its real heading is in fact still 270°- the compass is **over-reading**.

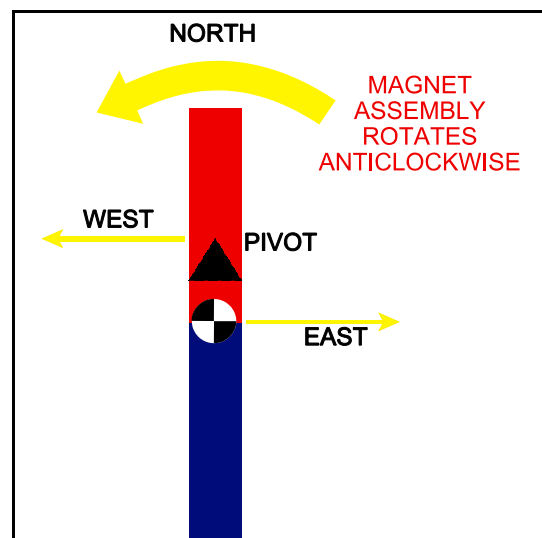

Figure 9.5 Acceleration on 270° M (Northern Hemisphere)

Acceleration on 090°M (NH)

Figure 9.6 shows an aircraft accelerating on a magnetic heading of 090°M in the Northern hemisphere. Since the magnet assembly is pendulously suspended, its inertia will cause it to swing back behind the pivot point. This displacement enables a turning couple to rotate the magnet assembly **clockwise** round the pivot. The angle measured clockwise from the North-seeking end round to the aircraft's nose reduces. The compass reading will therefore **decrease**, so indicating an **apparent turn towards North**.

Thus, according to the compass, the aircraft is now heading, say, 080° whereas its real heading is in fact still 090°- the compass is **under-reading**.

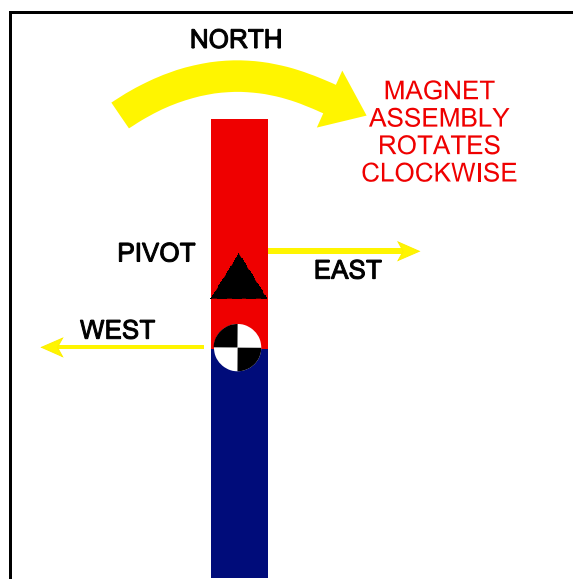

Figure 9.6 Acceleration on 090°M (Northern Hemisphere)

Deceleration on 090°M (NH)

Figure 9.7 shows an aircraft decelerating on a magnetic heading of 090°M in the Northern hemisphere.

Since the magnet assembly is pendulously suspended, its inertia will cause it to swing forwards ahead of the pivot point.

This displacement enables a turning couple to rotate the magnet assembly **anti-clockwise** round the pivot.

The compass reading will therefore **increase**, so indicating an **apparent turn towards South**. Thus, according to the compass, the aircraft is now heading, say, 100° whereas its real heading is in fact still 090°- the compass is **over-reading**.

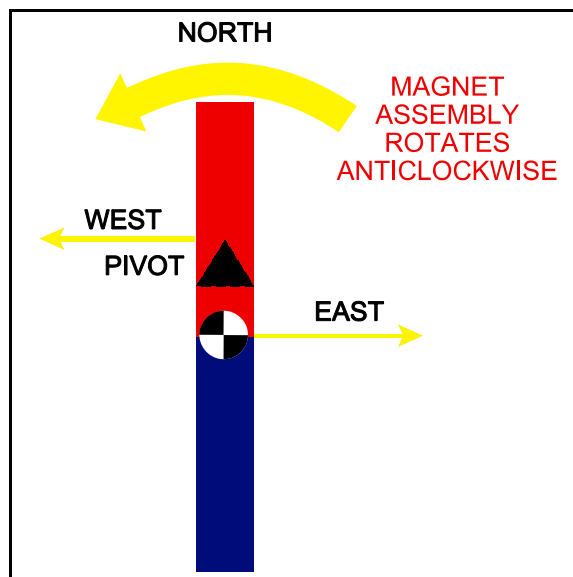

Figure 9.7 Deceleration on 090° M (Northern Hemisphere)

Acceleration on 270°M (SH)

Figure 9.8 shows an aircraft accelerating on a magnetic heading of 270°M in the Southern Hemisphere. The inertia will cause the magnet assembly to swing back behind the pivot point which is now offset to the south of the magnet's centre of gravity. This displacement enables a turning couple to rotate the magnet assembly **clockwise** round the pivot.

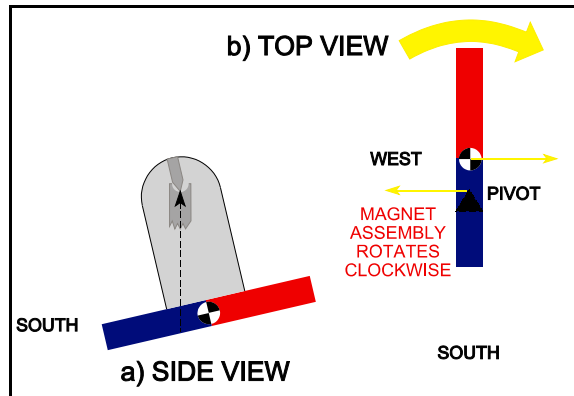

Figure 9.8 Acceleration on 270°M (Southern Hemisphere)

The compass reading will therefore **decrease**, so indicating an **apparent turn towards South**. Thus, according to the compass, the aircraft is now heading, say, 260° whereas its real heading is in fact still 270°- the compass is **under-reading**.

Acceleration on a northerly heading (NH)

Figure 9.9 shows an acceleration on a northerly heading (northern hemisphere).

The cg lags and the North-South tilt of the magnet assembly changes, but the magnets are tilting in the vertical plane of the magnetic meridian through the pivot - so no error occurs.

With deceleration on North/South headings there is again no error, only a reduced N/S tilt due to the inertial forward swing of the magnet assembly.

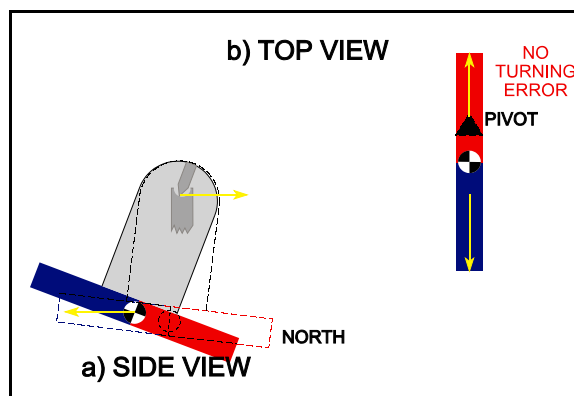

Figure 9.9 Acceleration on 360°M (Northern Hemisphere)

SUMMARY OF ACCELERATION ERRORS

Acceleration errors are **zero** on **N/S magnetic headings** (in both hemispheres), increasing to **maximum** on **headings 090°M and 270 ° M**. **Acceleration** causes an **apparent turn** towards the **nearer pole** (apparent turn north in the northern hemisphere, apparent turn south in the southern hemisphere). **Deceleration** causes an **apparent turn** towards the **further pole** (apparent turn south in the northern hemisphere, apparent turn north in the southern hemisphere).

Whenever the **magnet** assembly is displaced **clockwise**, the **readings** will **decrease** and the compass will **under read**.

Whenever the **magnet** assembly is displaced **anti-clockwise**, the **readings** will **increase** and the compass will **over read**.

The size of a linear acceleration error depends on the:

- **heading**
- **magnitude of the acceleration**
- **design of the magnet system**
- **magnetic latitude** (which affects the relative strengths of H and Z).

The errors are **maximum** near the magnetic poles, decreasing to **zero** at the **magnetic equator**.

TURNING ERRORS

Turning errors are **maximum** when turning through **north** and **south**, and ignoring liquid swirl **zero** when turning through **east** and **west**.

The basic theory of turning errors is much the same as that for linear acceleration errors.

Due to the earth's vertical component of the magnetic field, **Z**, the **compass's cg** will be **displaced** from almost beneath the pivot point away from the nearer pole. In a **turn**, the aircraft accelerates towards the centre of the turn, and therefore an **acceleration force** acts through the **pivot** towards the centre of the turn, while the opposing **centrifugal force** due to **inertia** acts outward through the **cg**.

This results in the **magnet** assembly tending to 'swing out' from the turn, **rotating** the **magnet** assembly around the pivot point and producing a **turning error**.

Turning errors are usually more significant than acceleration errors for the following reasons:-

- They are inherently of greater magnitude because greater displacement of the magnet assembly is likely in turns.
- Turns occur more often and are likely to be more prolonged than linear accelerations.

Turning from 045° to 315° (NH).

Consider an aircraft executing a **left-hand turn** in the Northern hemisphere as it passes through 000°M.

The magnet's cg is displaced from beneath the pivot point away from the north pole due to the vertical component of the earth's magnetic field. Because of inertia the **magnet** assembly will be thrown out of the turn **rotating** the magnet assembly **anti-clockwise**.

If there was no turning error the magnet would remain stationary and the aircraft rotate 90° around it - resulting in the pilot seeing 90° passing beneath the compass's lubber line.

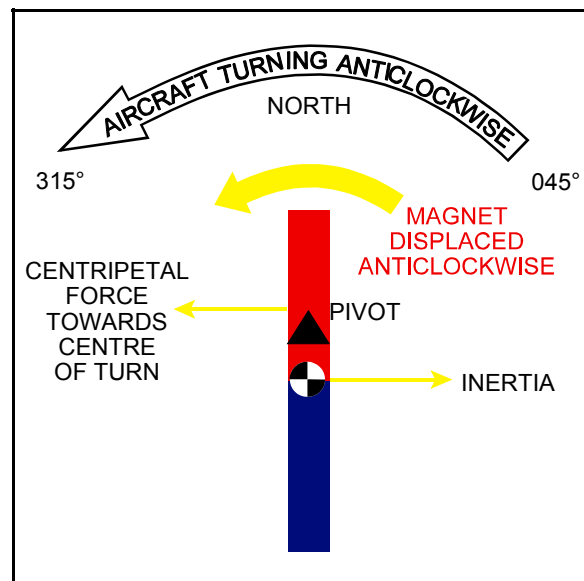

Figure 9.10 Turning from 045° to 315° (Northern Hemisphere)

However the **aircraft** is turning port and the **magnet** assembly **rotates** in the **same (anti-clockwise) direction**.

Although the aircraft has turned 90° around the compass, the magnet has been displaced and rotated in the same direction by a number of degrees (say 20°). The pilot will therefore only see 70° pass beneath the lubber line and the compass is termed **sluggish**.

Whenever the magnet rotates anticlockwise it will **overread** .

This means that if the pilot stops the turn at 315° **indicated** the **actual** heading will be numerically smaller such as 295°- therefore the **turn must be stopped early** (such as 335°) to achieve the correct heading.

This can also be described as **undershooting** the required heading (note 'undershoot' is referring to turning through a smaller **angle**, and should not be confused with 'under read' which means that the **numerical** heading indicated is too small).

If the pilot deliberately undershoots, rolling out when the compass reads about 325°, he should observe, when the wings are levelled, the compass 'catch up' and settle on 315°.

Turning from 315° to 045° (NH).

Consider an aircraft **turning right** through north in the Northern hemisphere as it passes through 000°M, the magnet's cg is displaced from beneath the pivot point away from the north pole due to the vertical component of the earth's magnetic field.

Because of inertia the **magnet** assembly will be thrown out of the turn **rotating** the magnet assembly **clockwise**.

Note: The aircraft and the magnet assembly are again rotating in the same direction (but that it is this time clockwise) and therefore the compass will again be sluggish.

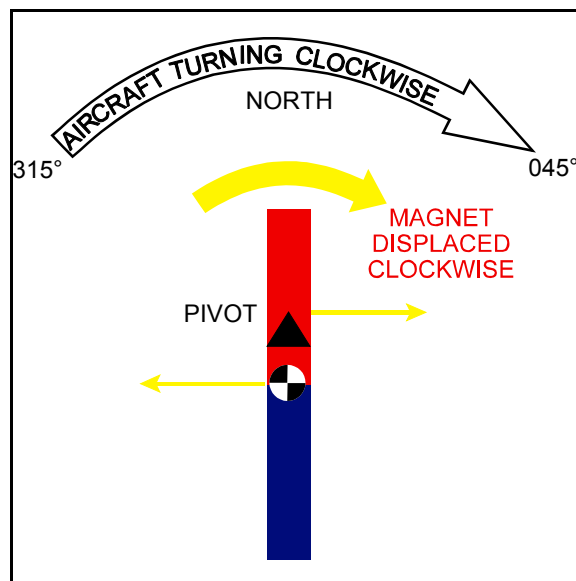

Figure 9.11 Turning from 315° to 045° (Northern Hemisphere)

Whenever the magnet rotates clockwise it will **under read**. This means that if the pilot stops the turn at 045° **indicated** the **actual** heading will be numerically larger such as 065°.

Therefore the **turn must be stopped early** (such as 025°), or the pilot should **undershoot the indication**, to achieve the correct heading.

Turning from 135° to 225° (NH).

Now consider an aircraft **turning right** as shown in Figure 9.11 through south in the northern hemisphere as it passes through 180°M, the magnet's cg is displaced from beneath the pivot point away from the nearer pole (the north pole) due to the vertical component of the earth's magnetic field.

Because of inertia the **magnet** assembly will be thrown out of the turn **rotating** the magnet assembly **anticlockwise**.

The **aircraft** is turning **clockwise** (right) but the **magnet** assembly is rotating anticlockwise.

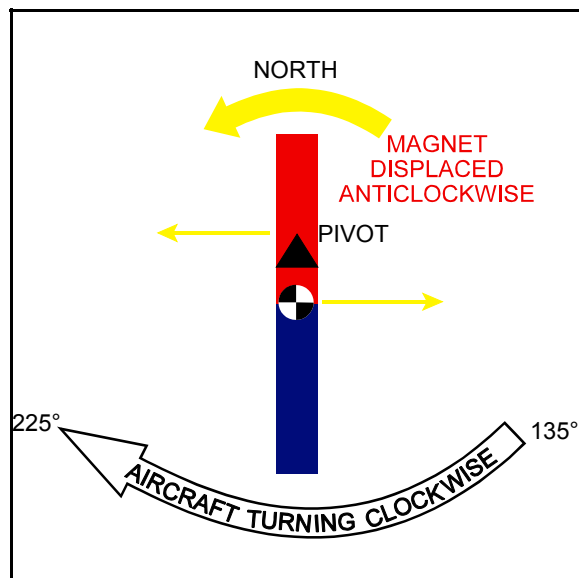

Figure 9.12 Turning from 135° to 225° (Northern Hemisphere)

Therefore the aircraft and the magnet are now **rotating in opposite directions**. Although the aircraft has turned 90° around the compass, the magnet has been displaced and rotated in the opposite direction by a number of degrees (say 20°). The pilot will therefore see 110° pass beneath the lubber line and the compass is termed '**lively**'.

Whenever the magnet rotates anticlockwise it will **over read**. This means that if the pilot stops the turn at 225° **indicated** the **actual** heading will be numerically smaller, such as 205°.

Therefore the **turn must be stopped late** (such as 245°), or the pilot should **overshoot**, to achieve the correct heading.

Turning from 135° to 225° (SH).

Now consider an aircraft **turning right** as shown in Figure 9.12 through south in the southern hemisphere as it passes through 180°M, the magnet's cg is displaced from beneath the pivot point away from the nearer pole (the south pole). Because of inertia the **magnet** assembly will be thrown out of the turn **rotating** the magnet assembly **clockwise**.

The **aircraft** and the **magnet** assembly now are **rotating** in the **same direction** (clockwise) and therefore the compass will again be **sluggish**.

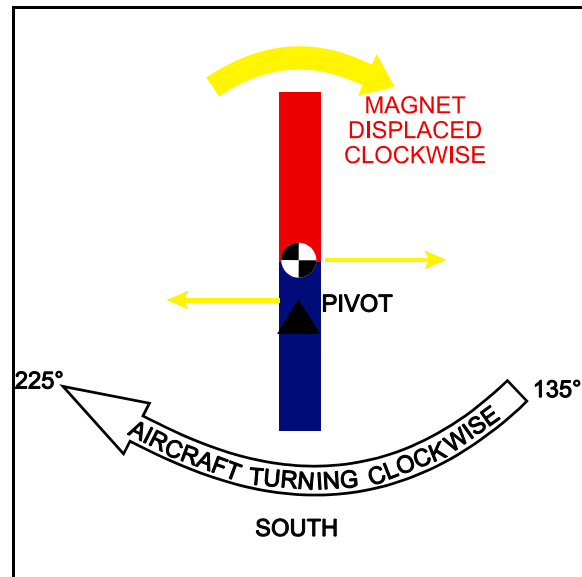

Figure 9.13 Turning from 135° to 225° (Southern Hemisphere)

Whenever the magnet rotates clockwise it will **under read**. This means that if the pilot stops the turn at 225° **indicated** the **actual** heading will be numerically larger such as 245°. Therefore the **turn must be stopped early** (such as 205°), or **undershoot**, to achieve the correct heading.

Remember that when the wings are levelled, the compass will 'catch up' and settle on 225°.

Turning through East or West

Consider a turning aircraft passing through the magnetic headings of 090° and 270°. The magnets are not horizontal but their tilt is North-South, that is in the vertical plane of the magnetic meridian through the pivot.

There is no rotational couple acting round the pivot, so there is no turning error.

Turning errors are zero when passing through East or West.

Other notes on turning errors:

It is **easier** to **steer** a **Southerly** rather than a **Northerly** heading, firstly because on South the compass does not indicate the wrong direction of turn as it can on North, and secondly because the 'lively' nature of the indications reduces the risk of over-correcting small steering errors.

Magnitude of Turning Errors:

There are many factors affecting the severity of turning errors. They are **worst** at **high latitudes** where **Z is strong** and H is weak.

Other relevant variables include **rate** of turn, **duration** of turn, **speed** of the aircraft, the **headings** involved, and the **design of the compass**.

TURNING ERRORS - LIQUID SWIRL

The effect known as liquid swirl was mentioned earlier. During a turn, the liquid in contact with the inside of the bowl tends to be dragged around with the bowl, so producing in the liquid small eddies which drift inwards from the circumference and **deflect the magnet assembly in the direction of turn**. Therefore the liquid tends to swirl - and rotate the magnet assembly with it - in the same direction as the aircraft's turn.

Accordingly, when turning through **north** in the **Northern hemisphere** it will **increase** the magnitude of the **turning error** (in which the assembly turns in the same direction as the aircraft).

The size of the turning error when turning through **south** in the **northern hemisphere** (where the assembly turns in the opposite direction to the aircraft) **will be reduced**.

In the Southern hemisphere the swirl effect will be in the opposite sense.

Note: At the magnetic equator where there is no vertical component Z in the earth's field, liquid swirl is the sole source of turning error; with most compasses the effect is only slight.

SUMMARY OF TURNING ERRORS

These are **maximum** when passing through magnetic **North** or **South**, decreasing to **zero** when passing through **East** or **West**.

The **error increases** with **increase** in **magnetic latitude**.

At the magnetic equator the only turning error is due to liquid swirl.

Whenever the pilot turns through the nearer pole (north in the northern hemisphere, or south in the southern hemisphere):

- the aircraft and compass **rotate** in the **same direction**,
- the **compass** will be **sluggish**, and
- the pilot should **undershoot** the turn / **roll out early**.
- **liquid swirl** will **increase** the turning error.

Whenever the pilot turns through the further pole (south in the northern hemisphere, or north in the southern hemisphere):

- the aircraft and compass **rotate** in the **opposite direction**,
- the **compass** will be **lively**, and
- the pilot should **overshoot** the turn / **roll out late**.
- **liquid swirl** will **reduce** the turning error.

Table of turning errors

Hemis ⁷	Turning		Aircraft Turns	Magnets' Turn	At the end of the turn compass reads	Stop turn	Effect of liquid swirl	Compass Condition
	From	To						
N	45	315	Anti Clockwise	Anti Clockwise	More than 315 deg	Early	Increases turning error	Sluggish
N	315	45	Clockwise	Clockwise	Less than 045 deg	Early	Increases turning error	Sluggish
N	135	225	Clockwise	Anti Clockwise	More than 225 deg	Late	Reduces turning error	Lively
N	225	135	Anti Clockwise	Clockwise	Less than 135 deg	Late	Reduces turning error	Lively
S	45	315	Anti Clockwise	Clockwise	Less than 315 deg	Late	Reduces turning error	Lively
S	315	45	Clockwise	Anti Clockwise	More than 045 deg	Late	Reduces turning error	Lively
S	135	225	Clockwise	Clockwise	Less than 225 deg	Early	Increases turning error	Sluggish
S	225	135	Anti Clockwise	Anti Clockwise	More than 135 deg	Early	Increases turning error	Sluggish

Table Explained

The term **SLUGGISH** which appears in the right hand column of the table denotes that the compass **HEADING** is **LAGGING BEHIND** the aircraft heading.

Conversely, when the term **LIVELY** is used, the compass **HEADING** is **LEADING** the aircraft around the turn.

The following rules of thumb apply:

- During a turn through the pole which is **physically nearer to the aircraft**, the compass will be **SLUGGISH**. It is therefore necessary to **ROLL OUT EARLY** on the indication given by the Direct Reading Compass.
- During a turn through the pole which is **physically further from the aircraft**, the compass will be **LIVELY**. It is therefore necessary to **ROLL OUT LATE** on the indication given by the Direct Reading Compass.

From the above statements it can be seen that, at the **MAGNETIC EQUATOR**, there is **NO TURNING ERROR** because there is no "dip".

Remember, that it is a displacement of the **MAGNETS** in a **CLOCKWISE** direction when viewed from above which causes the compass to **UNDERREAD**, and a displacement in an **ANTICLOCKWISE** direction which causes the compass to **OVERREAD**.

QUESTIONS

1. In a standby direct reading compass there is:
 - a. a non-pendulously mounted magnet system.
 - b. a single pendulously mounted bar magnet.
 - c. a circular magnet or pair of bar magnets pendulously mounted.
 - d. a low magnetic moment system, either of circular or bar configuration.

2. The main requirements of a direct reading magnetic compass are that it should be:
 - a. horizontal, sensitive, periodic.
 - b. easily read, floating in a transparent liquid, quick to react to change in aircraft heading.
 - c. positioned directly in front of the pilot, easily corrected for magnetic deviation, aperiodic.
 - d. aperiodic, horizontal, sensitive.

3. For a position in the southern hemisphere, the effect of acceleration errors are greatest on headings:
 - a. 180 ° and 360 °
 - b. 045 ° and 225 °
 - c. 135 ° and 315 °
 - d. 090 ° and 270 °

4. An aircraft in the southern hemisphere is turning from a heading of 045 ° © to 315 ° © using a DGI. At the end of the turn the compass will read than 315 ° and liquid swirl will this effect.
 - a. more; increase
 - b. less; increase
 - c. more; decrease
 - d. less; decrease

5. In a standby compass the magnet system is immersed in a transparent liquid. The purpose of this liquid is to:
 - a. increase sensitivity, increase aperiodicity.
 - b. increase sensitivity, decrease aperiodicity.
 - c. increase sensitivity at high latitudes, lubricate bearings.
 - d. increase sensitivity, reduce liquid swirl.

6. To improve the horizontality of a compass, the magnet assembly is suspended from a point:
 - a. on the centre line of the magnet.
 - b. below the centre of gravity.
 - c. above the centre of gravity.
 - d. varying with magnetic latitude.

7. The magnitude, and sense, of turning error shown by a direct reading compass varies with:
1. the design of the compass.
 2. the direction of the turn.
 3. the rate of turn.
 4. which hemisphere the aircraft is in.
 5. the heading of the aircraft.
 6. the amount of dip at the aircraft's latitude.

Of these statements:

- a. only 1, 2, 5 and 6 are correct.
 - b. only 1, 3, 5 and 6 are correct.
 - c. only 2, 4 and 5 are correct.
 - d. all are correct.
8. During a sustained turn the nearer magnetic pole, the effect of liquid swirl will compass turning error.
- a. away from; increase.
 - b. towards; not affect.
 - c. away from; not affect.
 - d. towards; increase.
9. When carrying out a turn at the magnetic equator there will be:
- a. no turning error.
 - b. a tendency to underread turns through south and overread turns through north.
 - c. a tendency to underread turns due to liquid swirl.
 - d. no turning error when turning through east or west

ANSWERS

- 1 C
- 2 D
- 3 D
- 4 D
- 5 A
- 6 C
- 7 D
- 8 D
- 9 C

CHAPTER TEN

GYROSCOPES

Contents

INTRODUCTION135

THE GYROSCOPE135

GIMBAL RINGS135

THE FUNDAMENTAL PROPERTIES OF A GYROSCOPE136

FACTORS AFFECTING RIGIDITY139

PRECESSION RATE139

WANDER139

SPACE, FREE, AND TIED GYROS140

RATE GYROS141

SUMMARY141

THE APPLICATION OF THE PROPERTIES OF A GYRO142

SUCTION AND ELECTRIC GYROS142

SUCTION AND ELECTRIC TYPES - COMPARISON143

QUESTIONS144

ANSWERS146

INTRODUCTION

A knowledge of higher mathematics is required if the subject of gyro dynamics is to be fully comprehended. However, this is unnecessary for an adequate understanding of the basic principles of the gyroscopic flight instruments. This chapter aims to provide sufficient background knowledge for the study of the Artificial Horizon, Directional Gyro Indicator, and the Rate of Turn Indicator.

THE GYROSCOPE

Any rotating body exhibits gyroscopic phenomena. The earth is a gyro, spinning about the axis between the geographic poles. The road wheel of a car is a gyro when it is turning, and so is a child's 'top'. The rotor in an aircraft gyro may be little more than an inch in diameter, spinning at perhaps 25,000 r.p.m.

GIMBAL RINGS

These are the supports for the rotor of a gyroscopic instrument. Gimbal rings, are known briefly as gimbals, and sometimes spelled gymbals.

Figure 10.1 shows a spinning rotor mounted in two gimbal rings, the outer one being supported by a fixed frame. The rotor itself is a metal disc rotating about the axis indicated as X-X and usually called the rotor spin axis. The rotor shaft (or spindle) is supported by bearings in a ring called the **inner gimbal**.

The inner gimbal is in turn supported by bearings mounted inside the **outer gimbal** which can rotate on bearings in the frame (or instrument case).

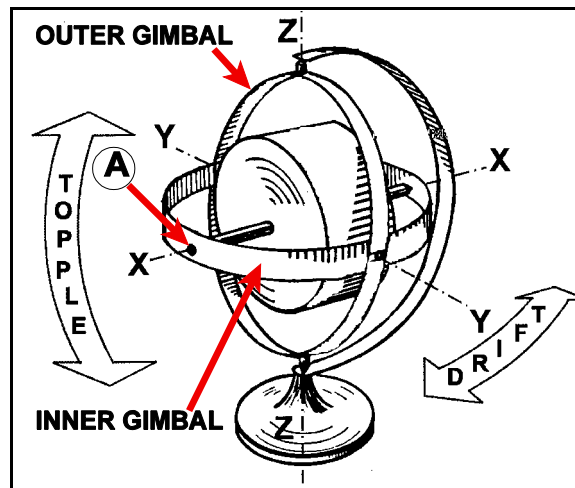

Figure 10.1. The Rotor and Gimbals.

In Figure 10.1, the 2 full-circle rings are gimbals. The outer half-ring (the D-shape) is called the frame and is attached to the floor support. This floor support is firmly fixed to the airframe, and so the gyro frame manoeuvres with the aircraft.

The pivots at X, Y and Z allow the gyro axis XX to remain in its fixed horizontal alignment as the aircraft manoeuvres in pitch, roll or yaw. The gyro axis, therefore continues to provide a steady reference even on a moving aircraft.

Some gyros use **two gimbals**. These measure **angular displacement from a known reference**. They are called **displacement gyros**. Displacement gyros are defined as 'two degrees of freedom' gyros.

Other types of gyro use **one gimbal**. They measure **angular rate**. They are called **rate gyros**. They are defined as 'one degree of freedom' gyros.

THE FUNDAMENTAL PROPERTIES OF A GYROSCOPE

Rigidity. A spinning rotor maintains its axis pointing in a fixed direction in space, unless subjected to an external force. This property is called **rigidity in space** or **gyroscopic inertia**

Precession. If an external force (or more correctly, torque) is applied to change the direction of the rotor axis, the gyro resists angular movement in the plane of the torque applied and instead moves in a plane at right angles to that of the torque, the resulting movement being called '**precession**'. This is the second fundamental property of a gyroscope.

With the space gyro, if the instrument case or frame is turned through 90° about its YY axis, that is, in the direction of the broad arrow in Figure 10.2a, so that the inner and outer gimbals lie in the same plane, any movement now imparted about the ZZ axis (in the direction of the broad arrows in Figure 10.2b) can no longer be taken up by a bearing so any torque applied will change the alignment of the rotor axis.

This condition is known as **gimbal lock**; we have reduced the number of rotational axes, and the gyro will precess, about the YY axis until the rotor axis is aligned with the ZZ axis. At this point precession will cease because the gyro is offering no further resistance to the applied force.

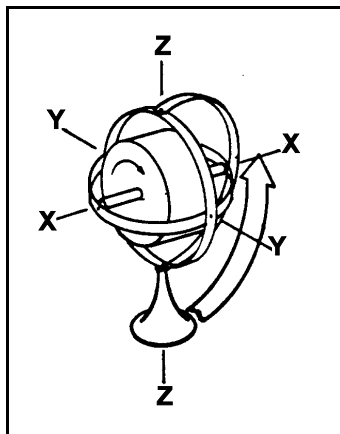

Figure 10.2a

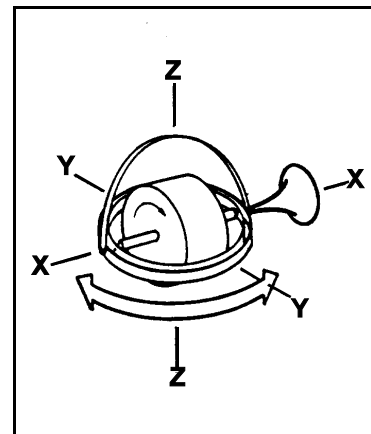

Figure 10.2b

Rule of Precession

The direction of precessional movement can be found by the following rule:-

The gyro will precess in a direction at 90° to the applied force, measured round the circumference of the rotor in the direction of spin. The force applied appears to have moved 90° in the direction of spin.

Figures 10.3a and 10.3b show examples of precession producing Drift and Topple.

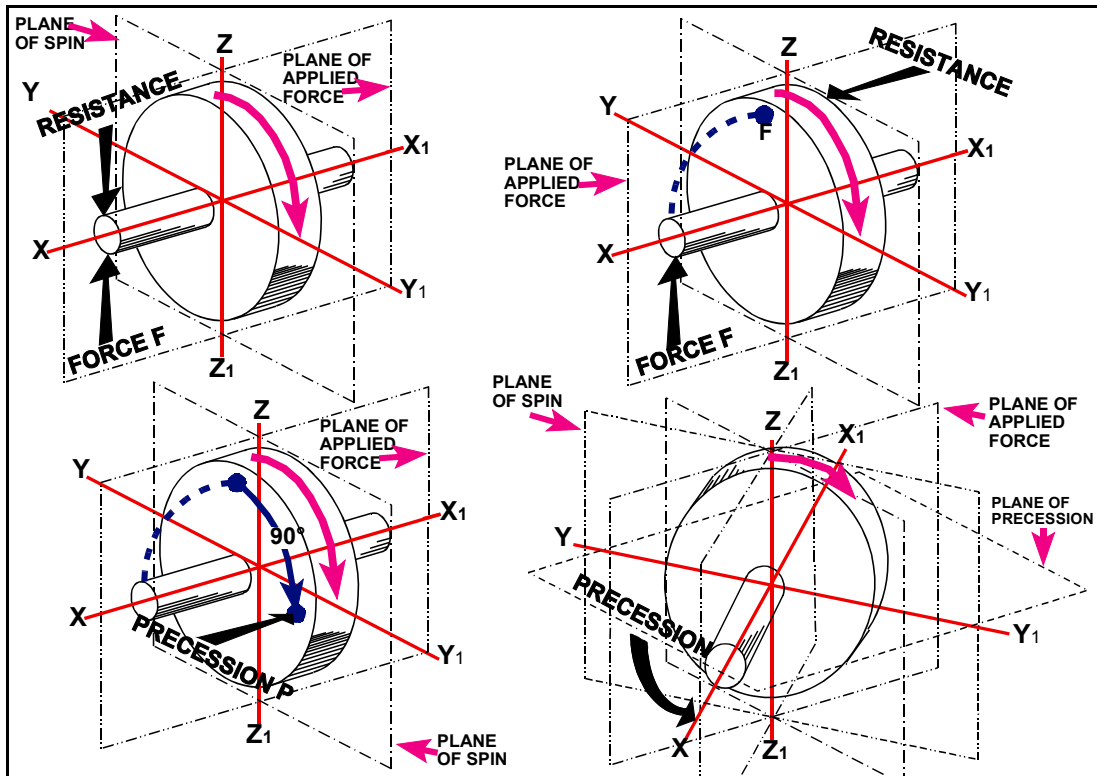

Figure 10.3a Precession Producing Drift

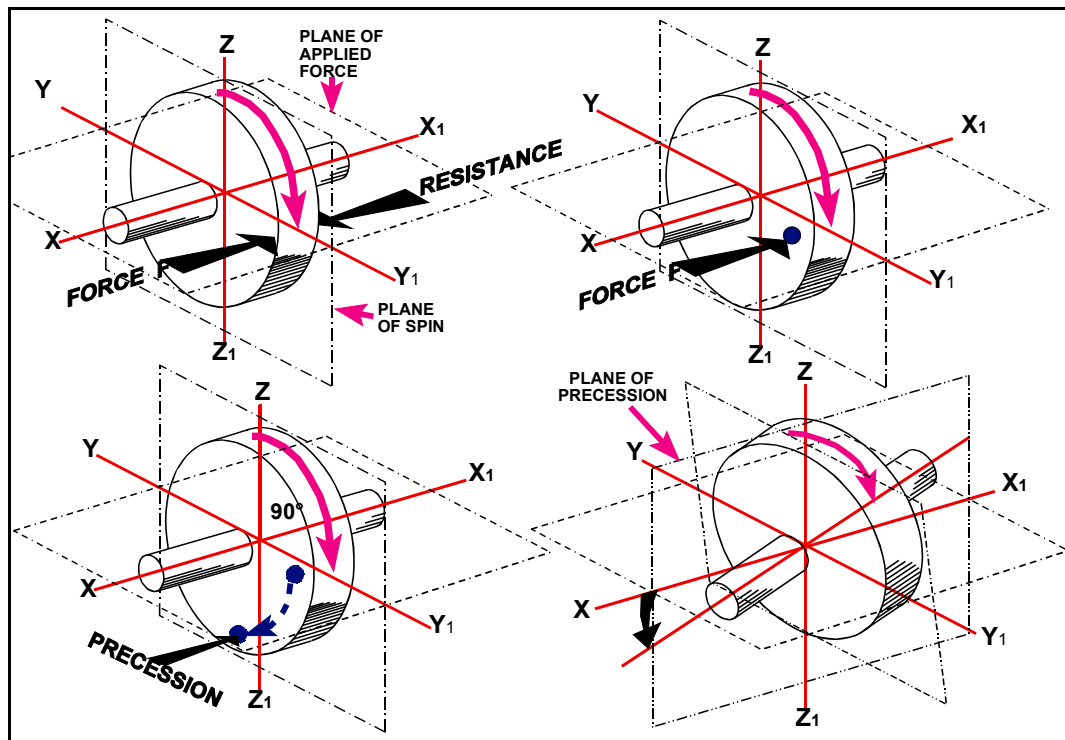

Figure 10.3b. Precession Producing Topple

As an example, if a weight is hung from the inner gimbal at point A in Figure 10.1, the gyroscope (rotor, inner and outer gimbals) will precess (rotate) in an anticlockwise direction about the axis (viewed from above). Further examples of the application of the rule of precession will be found in the chapters on individual gyroscopic flight instruments.

A gyroscope can not precess in the direction of rotation. Therefore a gyroscope can only have freedom to precess in a maximum of two perpendicular planes. This is referred to as "freedom in precession" - giving a maximum of **two degrees of freedom in precession**. A gyroscope that is used to measure changes about one, or more, axes is known as a displacement gyroscope.

FACTORS AFFECTING RIGIDITY

The gyroscopic inertia or rigidity of a gyro rotor can be expressed as $I\omega$ where I is the moment of inertia of the rotor about its spin axis and ω is the angular velocity about that axis. Therefore if we increase the moment of inertia or the rpm, the rigidity will be increased. The moment of inertia (I) can be stated as Mk^2 where M is the mass of the rotor, and k is the radius of gyration (the 'radius at which the mass acts'). Therefore to increase gyroscopic inertia, the moment of inertia would be increased by increasing M and / or k . This is achieved in air-driven gyros by using brass for the rotor and, as far as possible concentrating the metal round the rim, so increasing the effective radius. Summarising, increase of rotor mass, effective radius, or spin rpm will increase the gyroscopic rigidity. At the same time, the rigidity must be considered in terms of the applied force. For example, a kilogram weight hung on the inner gimbal at A (Fig 10.1) will have more effect (producing a greater rate of precession) than a one gramme weight hung in the same position.

PRECESSION RATE

The formula for the rate of precession (Ω) is:-

$$\Omega = \frac{T}{I\omega}$$

Where: T is the applied torque

I is the moment of inertia of the rotor

ω is the angular velocity of the rotor

Thus the rate of precession (Ω) is proportional to T , or the greater the applied force (torque) the greater the rate of precession - as stated in the previous paragraph.

The rate of precession is **inversely** proportional to $I\omega$, the rigidity or gyroscopic inertia, so the greater the rigidity the smaller the rate of precession produced by a given applied force.

WANDER

If the axis of a gyro rotor departs from its chosen direction it is said to **wander**. If the axis of the gyro rotor wanders in the horizontal plane (for instance, as shown by the horizontal arrow in Figure 10.1) it is said to **drift**.

A weight hung on the gimbal at A in Figure 10.1 thus produces drift. If the rotor axis wanders in the vertical plane (as shown by the vertical arrow in Figure 10.1.) it is said to **topple**.

Real Wander

Manufacturing imperfections in a gyroscope cause small rates of 'random' precession. Other terms given to this precession are 'balance wander' or, if the precession is in the horizontal plane, 'mechanical drift'.

The imperfections concerned are uneven rotor bearing friction, unbalanced gimbals, and friction in gimbal bearings. In-flight turbulence may increase the effect of these imperfections. The precession caused by application of an external force to a gyro is another example of real wander.

Earth Rate

Consider a space (or 'free') gyro, at A in Figure 10.4(a), with the rotor axis horizontal and aligned with the geographic meridian.

The rotor axis is indicating the direction of true North on the earth and is also aligned with a point at an infinite distance in space.

Some time later when point A on the earth has rotated to B in figure 10.4(b), the gyro rotor axis is still aligned with the same fixed point in space (assuming no other disturbing forces) but no longer indicates the direction of North on the earth. It has therefore changed its alignment, **according to the earthbound observer**, by the angle NOX. This is known as **Earth Rate**.

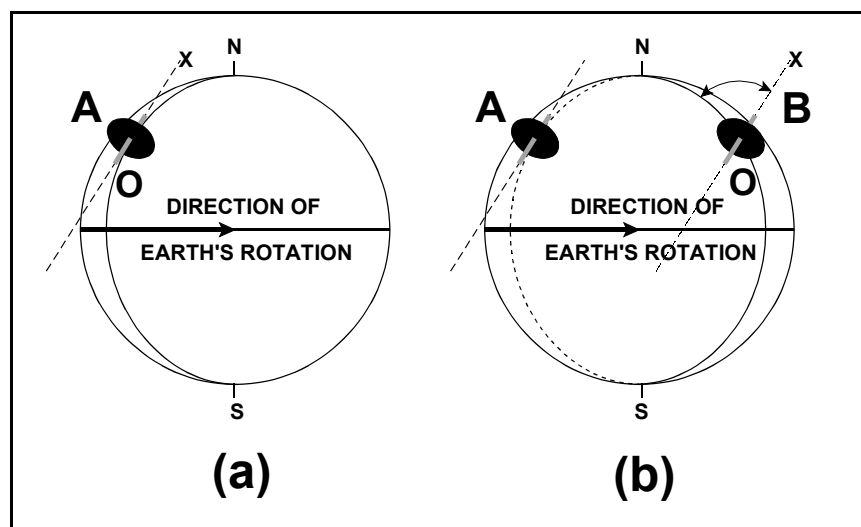

Figure 10.4 Apparent Wander

SPACE GYROS AND TIED GYROS

The gyro and gimbal arrangement in Figure 10.1 would, in a perfect gyro with no mechanical errors, result in the gyro axis being maintained in an **alignment relative to inertial space**. This is called a **space gyro**, and such systems are used in **inertial navigation systems** and in a spacecraft.

A gyro which relates its rigidity to a particular attitude or direction rather than to a space direction has more applications. Such a gyro is called a **tied gyro**.

A **tied gyro** can be described as one with two degrees of freedom, but with the rotor kept (or 'tied') in some desired position by a control system. As an example, the DGI rotor axis is maintained in the yawing plane of the aircraft.

An **earth gyro** (as in the Artificial Horizon) is a tied gyro which utilises the force of gravity to monitor a control system keeping the rotor axis in the earth's vertical.

RATE GYROS

If a gyro has only one gimbal ring, with consequently only one degree of freedom, it can be adapted for use as a **rate gyro** to measure a rate of angular movement. If the gyro frame is rotated in the plane in which the gyro has no freedom, the rotor will precess, unless restrained, until its plane of rotation coincides with the plane in which the frame is being turned. If this precession is restricted by a spring, as shown in Figure 10.5, the resultant tilt of the rotor will be a measure of the rate of angular movement of the instrument.

Rate gyro theory is considered more deeply in the notes on the Rate of Turn Indicator.

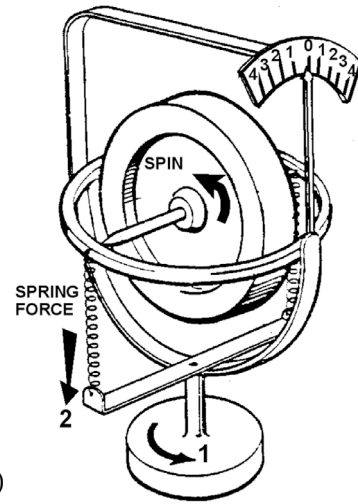

Figure 10.5
A Rate Gyro (A Rate of Turn Indicator)

SUMMARY

The following brief explanations of terms may help to clarify the foregoing paragraphs:-
Gyroscopic Inertia or **Rigidity in Space** is the property of a spinning body to maintain a fixed direction in space unless acted on by an outside force.

Precession is the movement of a gyro, resulting from the application of an outside force, about an axis perpendicular to both the spin axis and the applied force.

Real Wander is a precession caused by mechanical imperfections (such as uneven bearing friction) or by any applied force.

Apparent Wander is the observed wander of a gyro rotor axis relative to a datum on the earth.

Topple is rotor axis wander - real or apparent - in the vertical plane.

Drift is rotor axis wander - real or apparent - in the horizontal plane.

Space Gyro has two degrees of freedom, and so has gyroscopic inertia relative to a point in space.

A **Tied Gyro** has the rotor axis maintained (tied) in a desired position, so having gyroscopic inertia relative to the reference to which it is tied.

An **Earth Gyro** is a gravity-controlled tied gyro, so having gyroscopic inertia relative to the earth's vertical.

A **Rate Gyro** has one degree of freedom, and is constructed to measure rate of turn.

THE APPLICATION OF THE PROPERTIES OF A GYRO

The detailed application of the two properties of gyroscopic rigidity and precession are covered in the chapters devoted to the individual flight instruments. A general summary is given below.

Rigidity. This property is used to provide a directional datum. In the Directional Gyro Indicator (DGI), the rotor spin axis is horizontal and so provides a reference for the measurement of direction in azimuth (aircraft heading). The gyro in the DGI is sometimes known as an azimuth gyro. In the Artificial Horizon (AH), gyroscopic rigidity provides a pitch and roll attitude reference, the spin axis defining the earth's vertical. Such a gyro may be called a vertical axis gyro or vertical reference gyro.

Precession. As already explained, the application of an external force to a gyro produces movement of the rotor axis called precession. This property is used:-

- In the Rate of Turn Indicator - to measure angular velocities in the yawing plane.
- In the DGI control system - to maintain the rotor axis in the yawing plane. Additionally, to compensate DGI wander by means of a 'latitude nut'.
- In the Artificial Horizon control system - to maintain the rotor axis vertical.

SUCTION AND ELECTRIC GYROS

Gyroscopic flight instruments may be either air-driven or electric.

With the former, an engine-driven vacuum pump, or venturi tube on some light aircraft, reduces the pressure in the instrument case so that filtered replacement air is sucked in and led through a jet impinging on 'buckets' cut in the periphery of the rotor to make it spin like a water wheel. The air also operates the control systems of tied gyros.

With electric gyros, the rotor is an integral part - comprising the rotor windings - of an AC motor. The control system of an electric tied gyro is operated by limit switches and torque motors.

There are three designs of Gyro currently in use in aviation:

Tuned Rotor Gyro - a mechanical device using a spinning rotor which is engineered to be as balanced and frictionless as possible and which may be found in a number of different instruments.

Laser Gyro - more accurately described as a Rate Sensor this device uses Laser Light set in a rotational pattern to discern movement - it has no moving parts(to be discussed in full later).

Fibre-Optic Gyro - an extension of the Ring Laser Gyro but lighter, smaller and less expensive, but also less accurate. They may be used in a number of applications, (such as missile initial guidance) that do not require maximum long term accuracy and they may also be employed as a back up to another main system.

SUCTION AND ELECTRIC TYPES - COMPARISON

The advantages and disadvantages of Electric and Suction gyros:

- **Suction Gyros.** These are independent of electric power and so are not vulnerable to the risk of total electric failure. Unfortunately, moisture, dust, oil, and nicotine in the airflow penetrate the filter, reducing bearing life, unbalancing gimbals, and so impairing accuracy. At high altitude, adequate suction cannot be maintained. With a venturi tube, suction is insufficient on the ground and in flight such a tube is subject to icing risk.
- **Electric Gyros.** These are a later development than the suction types and in general are more expensive, heavier, and require AC power supplies. They have, however, important advantages over the air-driven types without the latter's disadvantages. The electric rotor can be constructed with higher moment of inertia and spin speed, giving greater rigidity and consequently improved stability. Rotor speed can, at any altitude, be accurately maintained, giving improved accuracy. Operating r.p.m. is more quickly reached when first switching on. The instrument case is sealed, for longer life and greater accuracy.

Note: It is usual to find that the "standby" instruments placed in aircraft are powered by suction if the main gyro instruments are powered by electrical means to allow for an alternate reference system in the event of an electrical power source failure.

QUESTIONS

1. Rigidity of a gyroscope depends on:
 - a. weight, force applied and speed of rotation.
 - b. rate of precession and the force applied.
 - c. weight, rate of precession and speed of rotation.
 - d. mass, radius of gyration and speed of rotation.

 2. A force is applied to deflect a gyroscope. If the RPM of the gyro is then doubled the precession rate will:
 - a. remain as before.
 - b. increase.
 - c. decrease.
 - d. cease altogether.

 3. In gyroscopic theory the term 'topple' is defined as:
 - a. real wander only, in the horizontal plane.
 - b. real wander only, in the vertical plane.
 - c. wander, real or apparent, in the vertical plane.
 - d. wander, real or apparent, in the horizontal plane.

 4. A force applied to the spinning axis of a rotor is precessed:
 - a. through 90° in the direction of spin of the rotor.
 - b. through 90° in the direction of spin of the rotor in the northern hemisphere through 90° in the opposite direction in the southern hemisphere.
 - c. through 270° in the direction of spin of the rotor.
 - d. at a rate proportional to the speed of rotation of the gyro.

 5. In gyroscopic theory the term 'drift' is defined as:
 - a. real wander only, in the horizontal plane.
 - b. wander, real or apparent, in the vertical plane.
 - c. apparent wander only, in the horizontal plane.
 - d. wander, real or apparent, in the horizontal plane.

 6. Real wander of a gyro can be caused by:
 - a. asymmetrical friction at the spinning axis.
 - b. rotation of the earth.
 - c. increasing the RPM of the rotor.
 - d. moving the gyro north or south of its present position.

 7. A gyro with only one degree of freedom is known as a:
 - a. tied gyro.
 - b. earth gyro.
 - c. space gyro.
 - d. rate gyro.
-

8. A perfectly balanced space gyro at the equator has its spin axis aligned with true north. After 6 hours the axis will be aligned with:
 - a. true east direction.
 - b. true west direction.
 - c. true north direction.
 - d. true south direction.

9. The main advantage of electric gyros are:
 - a. light weight, high RPM, constant speed, inexpensive.
 - b. high RPM, only require low voltage DC, constant speed, sealed casing.
 - c. high RPM, high moment of inertia, rapid build-up of speed, constant RPM.
 - d. sealed casing, constant speed, high precession rate, low cost.

10. Apparent wander of a gyro can be caused by:
 - a. rotation of the earth.
 - b. clear air turbulence.
 - c. gimbal friction.
 - d. external torque.

ANSWERS

- | | |
|----|---|
| 1 | D |
| 2 | C |
| 3 | C |
| 4 | A |
| 5 | D |
| 6 | A |
| 7 | D |
| 8 | C |
| 9 | C |
| 10 | A |

CHAPTER ELEVEN

DIRECTIONAL GYRO INDICATOR (DGI)

Contents

INTRODUCTION149

THE PRINCIPLE AND CONSTRUCTION OF THE DGI149

THE CONTROL SYSTEM - SUCTION GYROS.150

THE CAGING DEVICE152

DGI LIMITATIONS152

DGI ERRORS152

GIMBALLING ERRORS.153

RANDOM WANDER153

APPARENT WANDER (DUE TO ROTATION OF THE EARTH).153

LATITUDE NUT CORRECTION.156

ERRORS DUE TO UNSTABLE ROTOR RPM.158

EFFECT OF CHANGE OF AIRCRAFT LATITUDE ON COMPENSATED DGI. . . .158

TRANSPORT WANDER.159

DRIFT RATE CALCULATIONS159

QUESTIONS160

ANSWERS162

INTRODUCTION

The **directional gyro indicator (DGI)**, often called the '**direction indicator**' (DI) provides a **stable directional reference** in azimuth for maintaining accurate headings and for executing precise turns. There is **no magnetic element** in the DI, so it is not North-seeking and must initially be **synchronised** with the **magnetic compass**. The synchronisation must be checked at regular intervals because of real and apparent gyro wander (drift). The **DGI** does not therefore replace the compass; its stable, dead-beat indications are **complementary** to the North-seeking capability of the **compass**. Having no magnetic element, the DGI does not suffer from the compass turning and acceleration errors produced by the vertical component of the earth's magnetic field.

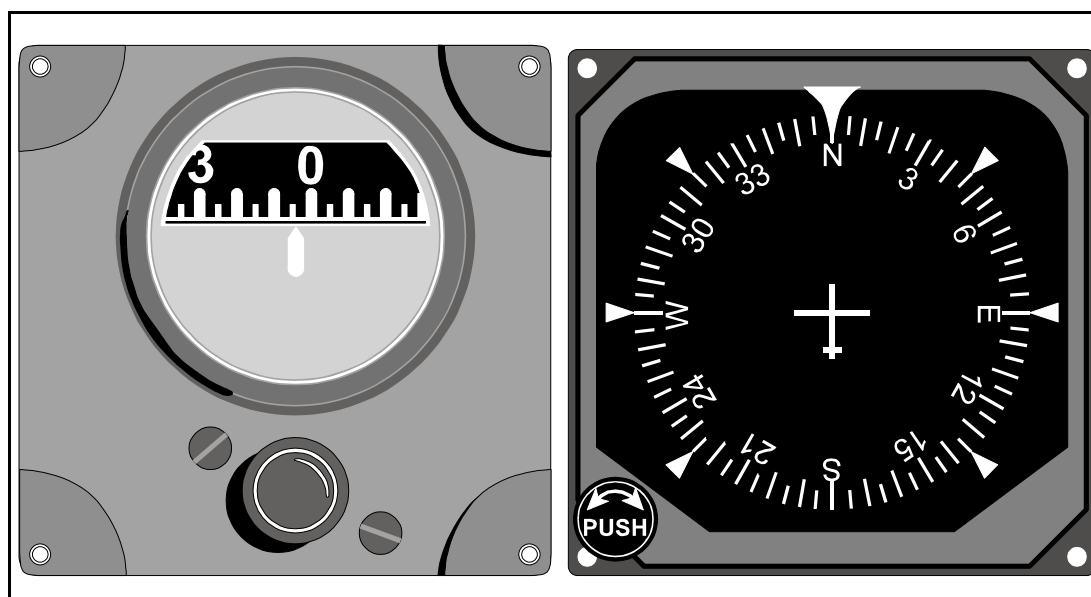

Vertical Display (Old)

Horizontal Display (Modern)

Figure 11.1 Two Directional Gyro Indicators

THE PRINCIPLE AND CONSTRUCTION OF THE DGI

The DI employs a **tied gyro**, that is to say, a gyro having freedom of movement in three planes mutually at right angles but with the **rotor axis** maintained in the **yawing plane** of the aircraft. This means that the rotor axis is horizontal in level flight, and because of gyroscopic rigidity it provides the datum from which heading can be measured.

The rotor is mounted in the inner gimbal (on bearings mounted in the outer gimbal) which has restricted freedom to turn. The outer gimbal can rotate through 360° about the aircraft's vertical axis, on bearings in the case.

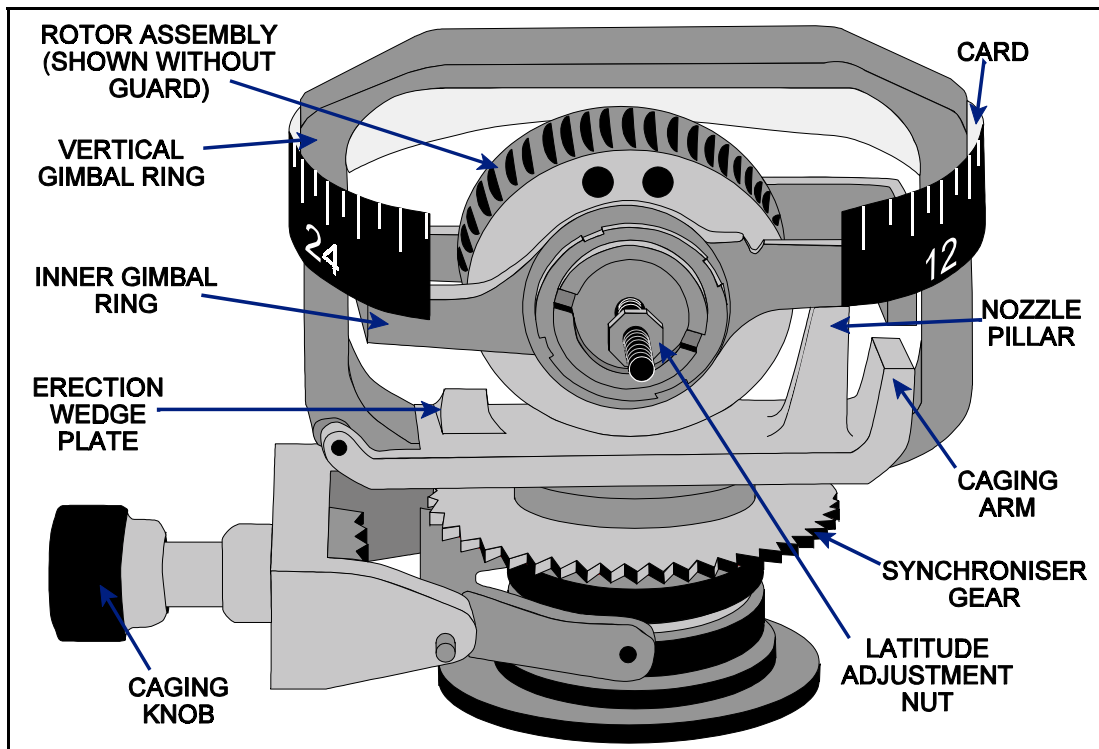

Figure 11.2 An Air Driven Directional Gyro

Note that the rotor axis, the inner gimbal axis, and the outer gimbal axis are mutually at right angles.

During a turn, the aircraft and instrument case turn on the vertical axis bearings of the outer gimbal whilst the gyro rotor, gimbals and indicating scale all remain fixed in azimuth because of gyroscopic rigidity.

Heading is indicated on the scale by a lubber line painted on a glass window in the instrument case. Some designs have a circular vertical-card indicating scale geared to the outer gimbal, in place of the cylindrical scale fixed to the outer gimbal in the earlier type shown in Figure 11.2.

THE CONTROL SYSTEM - SUCTION GYROS

With earlier designs of DGI, the rotor is driven by twin jets of air applied from the outer gimbal ring as shown in Figure 11.3. Suction is applied to the case of the instrument, and replacement air enters the case through a filter and is ducted to the jets on the outer gimbal which act on 'buckets' cut in the rotor.

The **jets** not only **spin** the rotor but also serve to maintain or **tie** the rotor axis in the yawing plane of the aircraft.

The rotor axis is lying in the yawing plane and therefore at right angles to the outer gimbal axis, the full force 'X' of the jets being used to drive the rotor (Figure 11.3). If the aircraft banks, gyroscopic rigidity keeps the rotor axis fixed in space and it is therefore no longer in the yawing plane.

The outer gimbal axis is no longer at right angles to the rotor axis, so the jet driving force 'X' acts at an angle to the plane of the rotor.

This force can now be resolved into two components, component 'Y' in the plane of rotation maintaining the spin of the rotor, and component 'Z' acting at 90° to the plane of rotation (Figure 11.4).

Because this is a gyro, the component 'Z' will precess the rotor as if the force had been applied at a point 90° around the circumference of the rotor in the direction of its spin.

The result will be as though a force 'Q' (Figure 11.4) was operating to re-erect the rotor with its axis in the yawing plane. If the heading is such that the rotor axis is aligned with the longitudinal axis of the aircraft, the application of bank alone (with no turn) will not displace the rotor axis from the yawing plane. This aspect is mentioned again in the paragraph on limitations.

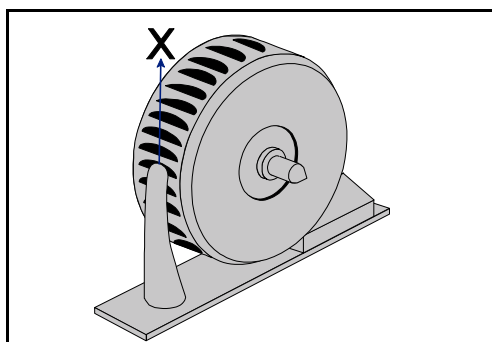

Figure 11.3 Rotor Axis in Yawing Plane

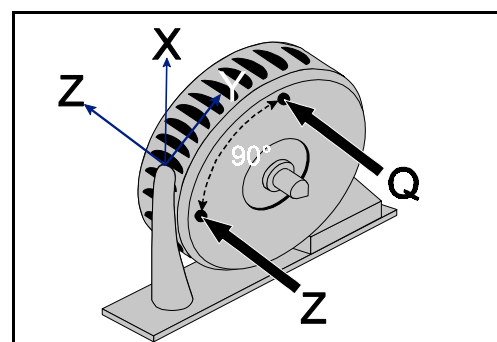

Figure 11.4 Rotor Axis Displaced

A second control system, which is usually combined with the above system works as follows: The **jet** of air **spins the rotor** and then flows round the outside of the rotor inside a metal case, as shown in Figure 11.5.

The air leaving the case is directed at a **wedge plate** fixed to the **outer gimbal**. When the gyro is correctly erected, this 'exhaust' jet is divided by the wedge plate into two equal streams producing equal reactions on the outer gimbal (R1 & R2). As soon as the rotor axis is displaced from the yawing plane the streams become unbalanced (Figure 11.6) and the reactions on the outer gimbal at the wedge plate also become unequal.

The resultant of these reactions applies a torque to the outer gimbal about the vertical axis of the gyro. This torque is instantaneously transmitted by the outer gimbal to the inner gimbal and is represented by force 'F' in Figure 11.6. This makes the rotor and inner gimbal precess.

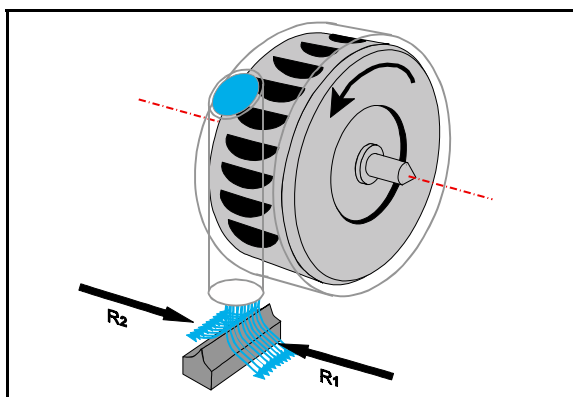

Figure 11.5 Rotor Axis in Yawing Plane

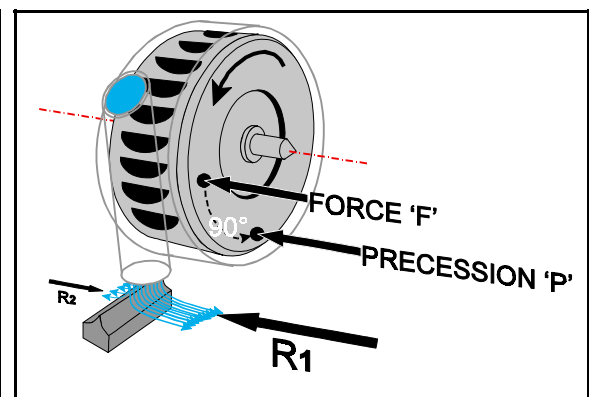

Figure 11.6 Rotor Axis Displaced

Thus an effective force 'P' acts to re-erect the rotor axis back into the yawing plane. If the gyro was displaced so far that the jet was nowhere near the wedge plate, then the first system would restore the gyro to its correct position.

The jet provides coarse adjustment and the wedge plate fine adjustment.

THE CAGING DEVICE

On the front of the instrument (see Figure 11.2) there is a caging knob which, when pushed in, moves a caging arm which locks the inner gimbal at right angles to the outer gimbal so locking the rotor axis in the yawing plane. At the same time a gear engages with the outer gimbal so that by turning the knob the gyro can be rotated and the scale reading synchronised with (usually) the compass reading.

The caging device is designed as described in order that:-

- The DGI can be synchronised with the compass and reset as required.
- The gyro will not topple during synchronisation.
- Toppling and possible damage to the instrument can be prevented by caging before manoeuvres in which pitch and roll limits may be exceeded.
- The gyro can be instantly re-erected and re-synchronised if it has toppled.

DGI LIMITATIONS

If the aircraft exceeds the pitch or roll limits of 85° (55° in air driven gyro DI's) the gyro will topple as the inner gimbal comes up against the stops, the precession causing the outer gimbal and scale to spin rapidly. Exceptions to this can occur:-

If the rotor axis is athwartships - 360° of aircraft rotation in the looping plane then being possible without toppling the gyro.

If the rotor axis is fore and aft - 360° of roll then being possible without toppling.

The actual indications on the scale at which these two situations can arise depend on the vintage and manufacture of the instrument.

DGI ERRORS

There are several reasons why it is virtually impossible for a DGI to remain synchronised with the compass. The most significant errors are listed below and dealt with in subsequent paragraphs.

- Gimballing errors.
- Random wander.
- Apparent wander due to earth's rotation.
- Errors resulting from varying rotor rpm.
- Apparent wander due to change of aircraft position (transport wander).

GIMBALLING ERRORS

These are **errors** in the indications of the DGI which occur when **bank is applied**. If the errors during a 360° turn are plotted, an approximate double sine curve results, with zero error on four headings (90° apart) spaced between alternate positive and negative peaks (two of each). The curve becomes more complex if pitch changes are made during the turn. The actual readings on the DI at which the maximum errors occur depend on its make and mark.

The errors are small, provided deviations in attitude from the level position are only moderate, and they disappear as soon as level flight is resumed. They occur because of the geometry of the gimbal system, in that unless the instrument case (and the aircraft bolted to it) are able to rotate about one of the axes of the gyro, the outer gimbal itself must move - giving an error - if the rotor axis is to maintain its fixed direction.

RANDOM WANDER

The gyro rotor axis may change its direction in space (real wander) or appear to change its direction (apparent wander) or suffer from both.

More details of real wander, which is mainly the 'random wander' due to **manufacturing imperfections**, are given in the chapter entitled 'Gyroscopes'. In the case of the DGI, gyroscopic rigidity is high and random wander (or drift) rates are low.

An air-driven type with the rotor spinning at 10,000 rpm has a drift rate of about 16° /hr. A later design with rpm of 20,000 has a quoted drift rate of 12°/hr.

Lower rates of only a few degrees per hour are possible with electrically driven indicators. The random wander rates with gyroscopes used in inertial navigation systems may be less than 0.01°/hr.

APPARENT WANDER (DUE TO ROTATION OF THE EARTH)

The apparent wander (or drift) of an azimuth gyro has already been mentioned briefly in the chapter on gyroscopes. It is now necessary to consider the magnitude of this wander.

An azimuth gyro (with the axis of the spinning rotor horizontal) is set up in gimbals and frame at the North (or South) pole. The rotor axis will stay rigid in space (assuming zero real wander) while the earth rotates under it through 360° in one day or $360/24 = 15^\circ$ in one hour.

An observer standing still watching the gyro, will move (with the earth) once round it in 24 hours (See Figure 11.7)

If the gyro is the DGI, its reading will be **decreasing** (at the **North** pole) at a rate of 15° /hr. At the South pole the reading would **increase** at the same rate. This is the **maximum** rate of apparent wander due to the earth's rotation.

Figure 12.8. shows a gyroscope set up on the ground at the **equator** with the axis horizontal and aligned North/South. In 24 hours, the observer and gyro will move with the earth once round the earth's axis of rotation. There is no change in the direction of the rotor axis relative to the meridian, so there is **zero apparent drift**. The **apparent drift rate** due to the earth's rotation is therefore a **function of latitude**, being maximum at the pole and zero at the equator.

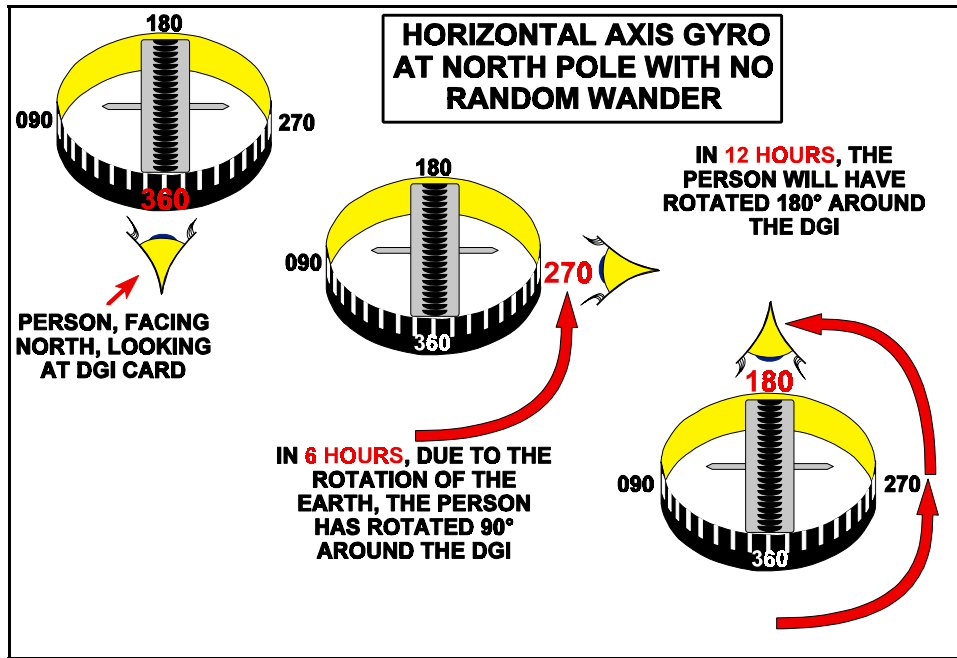

Figure 11.7 Apparent Wander at the North Pole

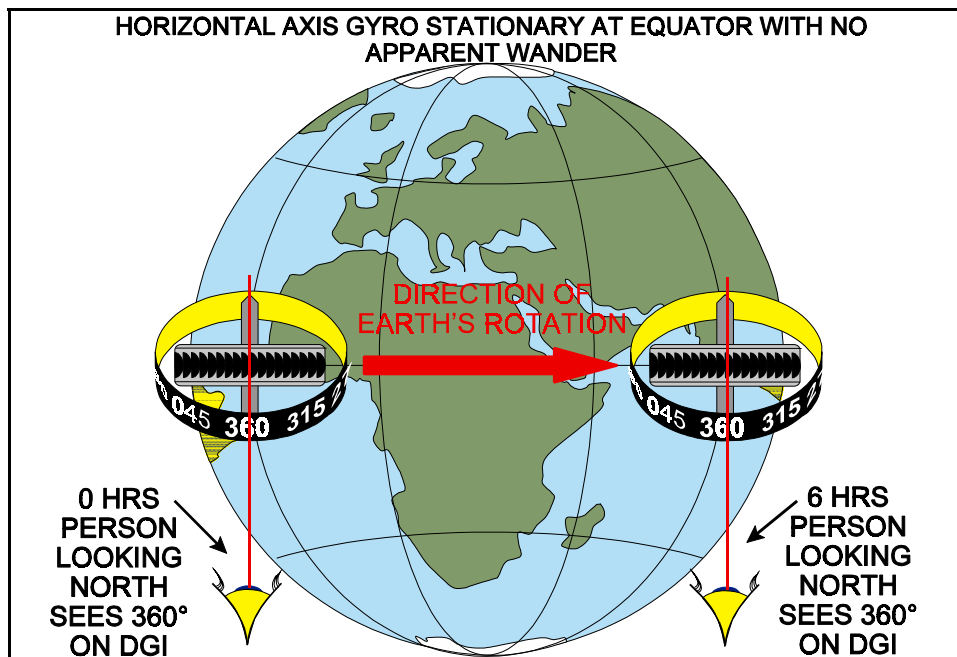

Figure 11.8 Apparent Wander at the Equator

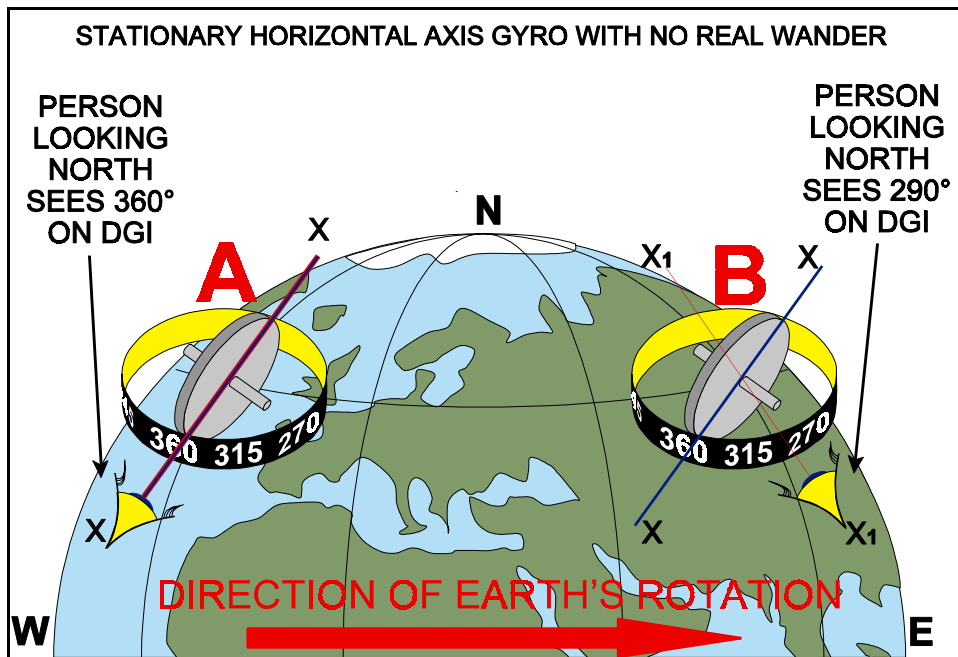

Figure 11.9(a) Apparent Wander at Intermediate Latitudes in the Northern Hemisphere

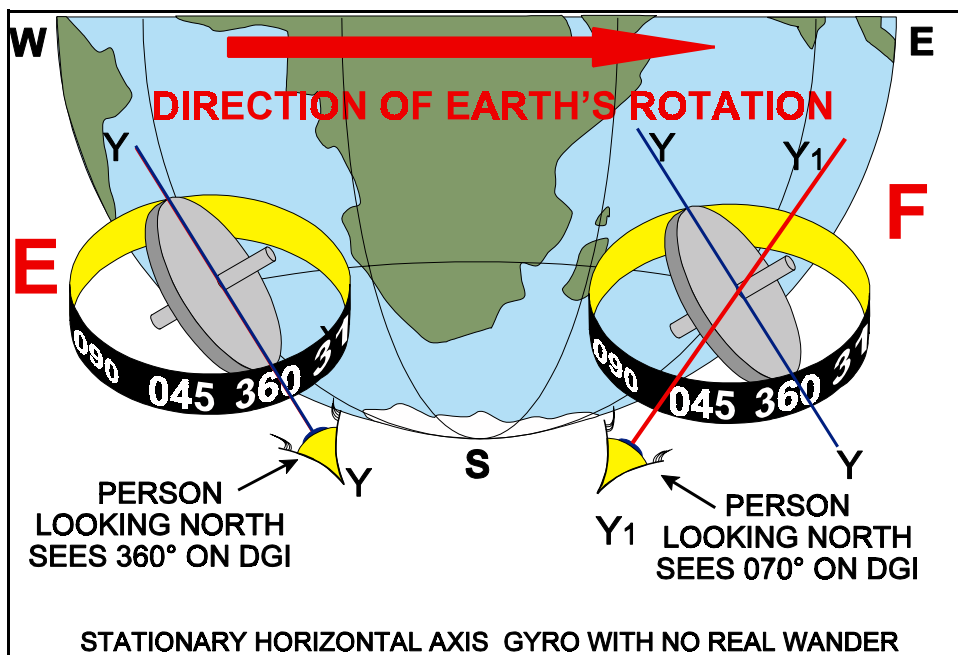

Figure 11.9(b). Apparent Wander at Intermediate Latitudes in the Southern Hemisphere.

Figure 11.9(a) demonstrates how the apparent drift due to the earth's rotation causes the reading of a DI to **decrease in the Northern hemisphere**.

At A, an observer looking North at the DGI reads 360°. When the observer and his gyro have rotated with the earth to B, the observer will see a value some degrees West of North (a DGI reading of less than 360°) because gyroscopic rigidity is keeping the gyro rotor axis aligned with a fixed direction in space.

The rotor axis cannot remain aligned N/S with the meridian because the latter, except at the equator, is continually changing its direction in space - its spatial orientation - as the earth rotates.

As the observer and gyro continue to rotate with the earth, the readings will decrease further. Similarly, it can be seen that if an observer and gyro located in the **Southern hemisphere** rotate with the earth from E, the readings of the DGI will **increase**.

Figure 11.10. shows graphically the variation of apparent drift with latitude. The drift rate is proportional to the sine of the latitude, so that assuming there is zero random drift and no compensation has been made:-

Apparent drift rate = 15 x sin lat (degrees per hour)

Note that this can only be correct if the gyro is 'stationary', meaning that it is not being moved or 'transported' from one place to another.

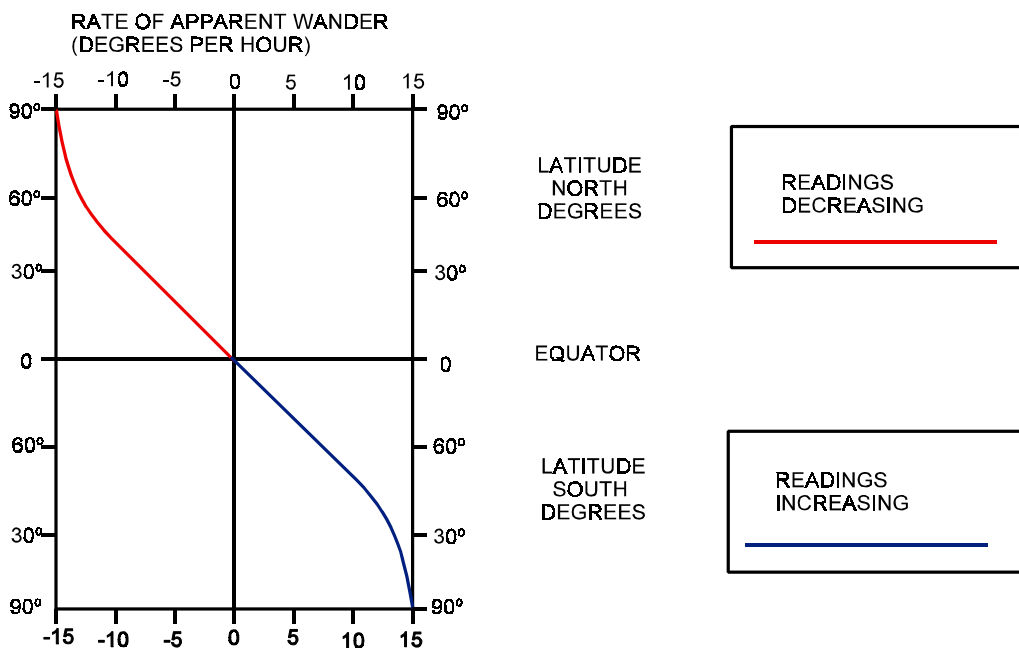

Figure 11.10 The Rate of Apparent Wander on an Uncorrected Gyro

LATITUDE NUT CORRECTION

Compensation for apparent wander (drift) due to the rotation of the earth is by means of an adjustable **latitude rider nut** on a threaded stud fixed horizontally to the **inner gimbal**.

In its central position (Figure 11.11.) the effect of the nut is cancelled by a counter-balance weight on the opposite side of the gimbal.

Screwed out a few turns, the nut applies a downward moment on the gimbal. This force, with the usual precession rule applied, produces (viewed from above) an anticlockwise precession of the gyro, including its scale, in azimuth. This would cause the reading in the window to increase.

Conversely, if the nut is wound in, clockwise precession occurs, making the readings decrease. Apparent drift due to the rotation of the earth can therefore be cancelled for a given latitude by using the latitude nut to produce an equal and opposite real drift. The ability to screw the nut in or out enables compensation to be made for increasing readings (Southern hemisphere) or decreasing readings (Northern hemisphere).

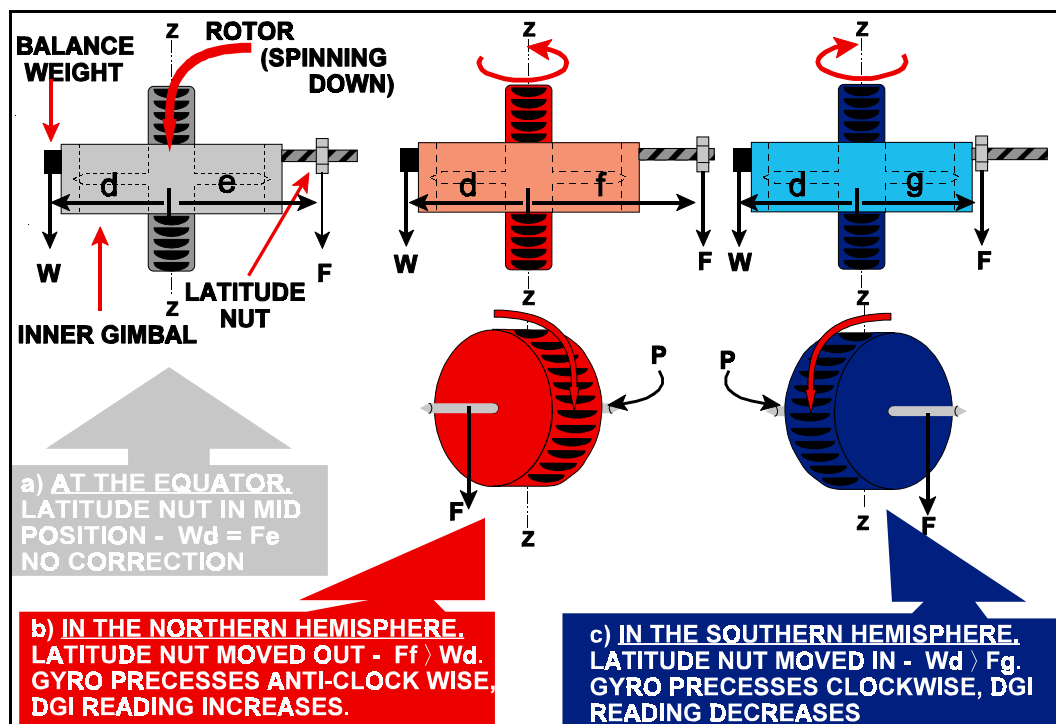

Figure 11.11 Compensation for Apparent Wander

The setting can only be changed under workshop conditions (not in the aircraft) so that compensation will only be correct for the chosen latitude. However, errors due to latitude changes are usually small compared with random wander errors of the DI.

Should the aircraft be moved to a new operating area involving a latitude change of the order of 60° , a DGI with the appropriate latitude correction would probably be substituted.

Figure 12.12. illustrates graphically the effect of compensating a gyro for the apparent drift of minus $13^\circ/\text{hr}$ at 60°N ($15 \sin 60^\circ$).

The latitude nut introduces a real drift of plus $13^\circ/\text{hr}$ so that the resultant drift (assuming no random error) will be zero at 60°N . It will be realised that the compensation of $+13^\circ/\text{hr}$ applied for 60°N will now be present at all latitudes, and this is represented in the graph by renumbering the drift scale.

The drift in the region of 60°N is negligible after compensation but if the aircraft is now moved to an area South of the equator the drift values will be greater than if no compensation had been made (as a study of Figure 12.12. will show).

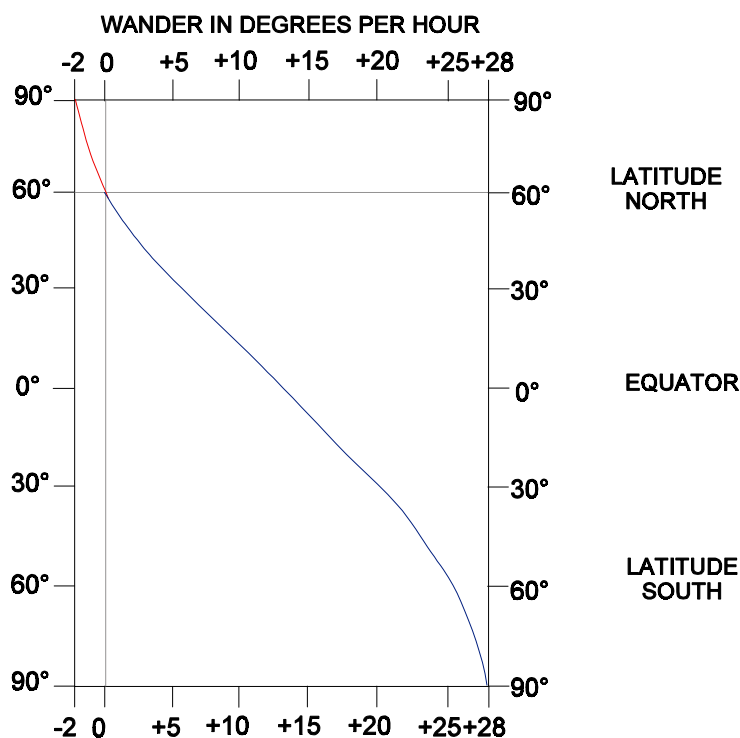

Figure 11.12 Gyro Corrected for 60°N

ERRORS DUE TO UNSTABLE ROTOR RPM

Since the rate of **precession** of a gyro **depends on rotor rpm**, over which no precise control is maintained in a suction-driven DGI, the latitude nut compensation is only approximate.

For instance, at high altitude with **inadequate suction**, the **rotor rpm** will be **lower** than the design value. This results in reduced gyroscopic rigidity and the latitude nut produces **too high a precession rate**, so **over-correcting** the apparent drift. Should rpm exceed the design figure, which is less likely to occur, the rigidity would increase and the latitude nut would produce a lower rate of precession so under-correcting the apparent drift.

EFFECT OF CHANGE OF AIRCRAFT LATITUDE ON COMPENSATED DGI.

It has already been stated that the apparent drift rate due to the earth's rotation varies with the sine of the latitude (Figure 11.10.).

If we consider an aircraft tracking due North, starting from the equator, the initial apparent drift rate of an uncorrected gyro is zero. As the flight progresses, the reading of the DGI decreases. By the time the aircraft reaches 30°N, the DGI reading is decreasing at a rate of 7½°/hr, and at 60°N it is decreasing at 13°/hr. It should be clear that in flight due North or South from the equator at constant ground speed the value of the apparent drift rate will increase from zero to an value of $15 \sin \text{lat}^\circ/\text{hr}$ at the pole. The rate of increase of drift rate will not be linear - because of the sine function. The same applies if a compensated gyro is transported North or South of its latitude of correction.

TRANSPORT WANDER

At any latitude other than the equator, meridians (which define local North) are not parallel. If the gyro is aligned to one meridian, then flown East to West, the new meridian will be inclined to the old by Transport Wander.

Summarising:

Flight North from the 'corrected latitude' gives a **decreasing reading** (a minus drift rate).

Flight South from the 'corrected latitude' gives an **increasing reading** (a plus drift rate).

Flight away from the 'corrected latitude' results in the **drift rate increasing**

Flight towards the 'corrected latitude' results in the **drift rate decreasing**

DRIFT RATE CALCULATIONS

Example 1

An aircraft is stationary at 60°N. Calculate the hourly wander rate, for an uncompensated gyro.

Solution 1

$$\text{Apparent wander} = - 15 \times \sin 60^\circ (\text{decreasing})^\circ/\text{hr} = - 12.99^\circ/\text{hr}$$

Example 2

An aircraft is stationary at 50°N. Assuming the DGI has no random error and is corrected for apparent drift due to the earth's rotation at 50°N, calculate the hourly wander rate.

Solution 2

Random wander	= 0°/hr	0
Latitude nut correction	= + 15 x sin 50° (increasing)°/hr	= +11.49°/hr
Apparent wander	= - 15 x sin 50° (decreasing)°/hr	= - 11.49°/hr
		= zero

Example 3

What is the hourly drift rate of a DGI in an aircraft at 25°S, if the gyro has been corrected for 10°N?

Solution 3

Latitude nut correction	= + 15 x sin 10° (increasing) °/hr	= + 2.60°/hr
Apparent wander	= + 15 x sin 25° (increasing) °/hr	= + 6.34°/hr
		= + 8.94°/hr
Total observed drift		(Increasing)

QUESTIONS

1. A directional gyro indicator is basically a:
 - a. horizontal axis earth gyro.
 - b. horizontal axis tied gyro.
 - c. vertical axis earth gyro.
 - d. vertical axis tied gyro.

2. Apparent wander may be corrected in a DGI by:
 - a. causing the gyro to precess in a clockwise direction (in the northern hemisphere).
 - b. attaching a bias weight to the inner gimbal which makes the gyro precess in azimuth in the same direction as apparent wander.
 - c. correcting wander by means of air jets.
 - d. attaching a bias weight to the inner gimbal which makes the gyro precess in azimuth in the opposite direction to apparent wander.

3. An air driven DGI is corrected for apparent wander at 56° N. If the aircraft is maintaining constant DGI readings:
 - a. when flying north from 56° N the true heading of the aircraft will decrease.
 - b. when flying east from 56° N the true heading will decrease.
 - c. when flying south from 56° N the true heading will decrease.
 - d. when flying west from 56° N the true heading will increase.

4. The formula used to calculate apparent wander of a directional gyro in the northern hemisphere is:
 - a. +15 sine latitude in degrees for the time of running.
 - b. +15 sine latitude in degrees per hour.
 - c. -15 sine latitude in degrees per hour.
 - d. 15 sine latitude in degrees per hour increasing.

5. Errors of the directional gyro are:
 - a. acceleration error, turning error, altitude error, transport wander, rotor speed error.
 - b. gimbaling error, random wander, apparent wander, rotor speed error, transport wander.
 - c. gimbaling error, looping error, rolling error, rotor speed error, transport wander.
 - d. transport wander, apparent wander, latitude error, turning error, acceleration error.

6. The spin axis of a directional gyro is maintained in by means of in an air driven gyro and by means of a in an electrically driven gyro:
 - a. the horizontal plane; air jets; wedge plate.
 - b. the vertical plane; air jets; torque motor.
 - c. the yawing plane; air jets; torque motor.
 - d. the yawing plane; air jets; wedge plate.

7. The purpose of the caging knob is:
 - a. to prevent the gyro toppling.
 - b. to reset the heading.
 - c. to reset the heading and to prevent toppling.
 - d. to prevent apparent wander.

8. In an air driven directional gyro the air jets are attached to:
 - a. the inner gimbal.
 - b. the outer gimbal.
 - c. the instrument casing.
 - d. the rotor axis.

9. The limits of pitch and roll for a modern directional gyro are respectively:
 - a. 55 and 85
 - b. 85 and 55
 - c. 55 and 55
 - d. 85 and 85

10. Gimballing error:
 - a. will disappear after a turn is completed.
 - b. will remain until the gyro is reset.
 - c. will only occur during a 360° turn.
 - d. will be zero on only two headings during a 360° turn.

ANSWERS

- 1 B
- 2 D
- 3 C
- 4 C
- 5 B
- 6 C
- 7 C
- 8 B
- 9 D
- 10 A

CHAPTER TWELVE

THE ARTIFICIAL HORIZON

Contents

THE ARTIFICIAL HORIZON INTRODUCTION165

CONSTRUCTION165

ARTIFICIAL HORIZON INDICATIONS166

LIMITATIONS167

CONTROL SYSTEMS168

THE AIR DRIVEN ARTIFICIAL HORIZON168

ACCELERATION ERROR IN THE AIR DRIVEN ARTIFICIAL HORIZON.170

TURNING ERRORS IN THE AIR DRIVEN ARTIFICIAL HORIZON172

RIGIDITY172

SERVICEABILITY CHECKS172

THE ELECTRIC ARTIFICIAL HORIZON.173

ELECTRIC ARTIFICIAL HORIZON CONTROL SYSTEM173

ACCELERATION ERRORS IN THE ELECTRIC HORIZON174

FAST ERECTION SYSTEM174

ADJUSTABLE AEROPLANE DATUM.174

VERTICAL GYRO UNIT175

QUESTIONS176

ANSWERS178

THE ARTIFICIAL HORIZON INTRODUCTION

The **artificial horizon** (AH) provides the pilot with **information** in terms of the aircraft's attitude both in **pitch** and **roll**. It is a primary instrument, replacing the natural horizon in poor visibility. The attitude display consists of a miniature aircraft shape or 'gull-wing' (tail view) painted or engraved centrally on the inside of the glass face of the instrument, and therefore fixed to the instrument case and the actual aircraft. Behind this representation of the aircraft is the horizon bar, linked to the gyro in such a way that the bar is gyro-stabilised parallel to the true horizon. The artificial horizon may be suction or electrically driven. It is also known as a gyro horizon and attitude indicator.

CONSTRUCTION

The artificial horizon uses an **Earth gyro** in which the spin axis is maintained in, or tied to, the **vertical** by Earth's gravity. This means that the plane of the rotor rotation is horizontal, so providing the stable lateral and longitudinal references required.

The basis of construction of an artificial horizon is illustrated in Figure 12.1.

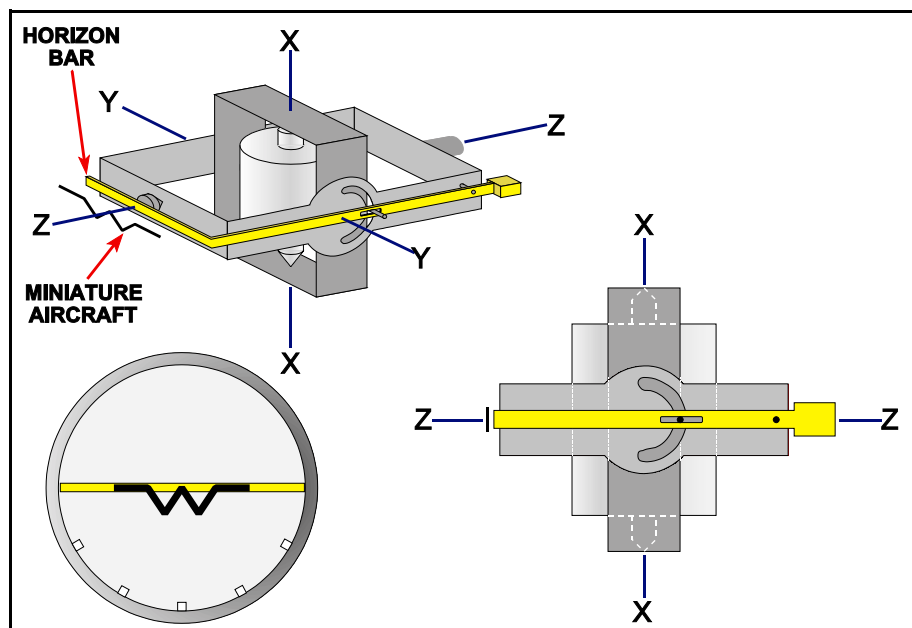

Figure 12.1 Pitch and Artificial Horizon

ARTIFICIAL HORIZON INDICATIONS

Figure 12.1. shows the three axes of the gyro; XX, YY and ZZ. Because the gyro is tied to the vertical note that the axis XX (the spin axis) will remain Earth vertical and therefore the axis YY will be Earth horizontal when the aircraft is straight and level.

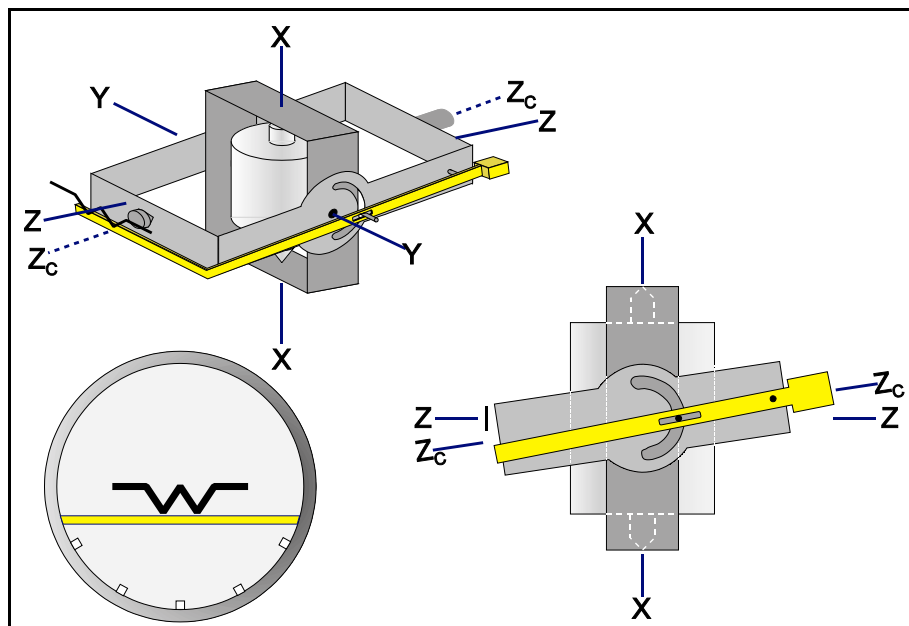

Figure 12.2 A Nose Up Attitude

Pitch

Figure 12.1. shows the level-flight attitude display and two views of the instrument with the case removed.

In Figure 12.2. a nose-up attitude (of 10 degrees) is shown. The pitch-up movement has rotated the case together with the attached outer gimbal ring about the lateral axis YY. As this occurs, a guide pin protruding from the stabilised inner gimbal forces the horizon bar arm down. The horizon bar is now below the gull-wing producing the nose-up indication. (Figure 12.5. shows the gimbal rings and the pitch-indication linkage in greater detail) The three views in Figure 12.3. relate to a pitch-down situation. Note that the angle of pitch may be selected using the pitch markers shown.

Roll

In roll, as with pitch, the rigidity of the vertical gyro provides the stable attitude reference. As the aircraft rolls (about the longitudinal axis - ZZ in the diagrams) the instrument case and the gull-wing will rotate about the stabilised gyro rotor and gimbal system.

The gyroscopic rigidity of the spinning rotor holds the horizon bar in the rolling plane so that the amount and direction of bank are displayed by the gull-wing relative to the horizon bar. A more accurate indication of the amount of bank is given by a pointer attached to the outer gimbal and showing bank angle on a scale painted on the face of the instrument.

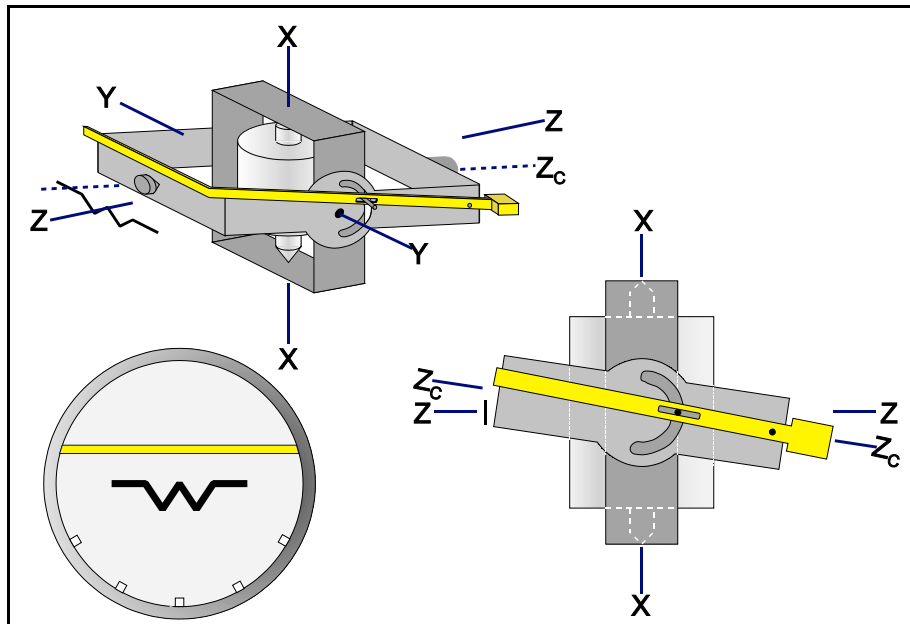

Figure 12.3 A Nose Down Attitude

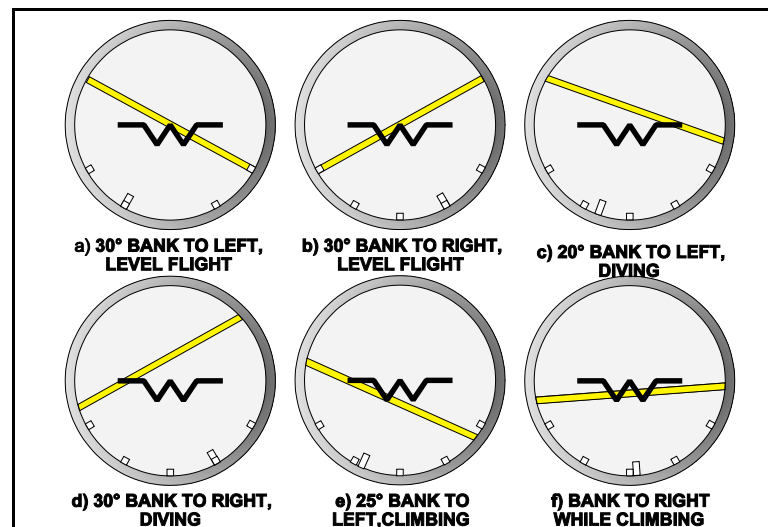

Figure 12.4

Figure 12.4 shows a number of artificial horizon displays with the aircraft in different attitudes.

LIMITATIONS

The amount the case can move relative to the gyro is controlled by fixed stops. With **older designs**, typical limits are $\pm 60^\circ$ in pitch and 110° each way in roll. In **modern instruments** there is **complete freedom in roll** and up to 85° (plus or minus) in pitch. If the limits are exceeded, the gyro 'topples', giving violent and erratic movements of the horizon bar. Unless a fast erection system is incorporated, accurate indications will not be obtained until the gyro has re-erected itself over a period of 10 to 15 minutes.

CONTROL SYSTEMS

The rotor assembly is made very slightly bottom-heavy in order to keep down the time taken for initial erection when the gyro is first started up, but a complex control system is required to maintain the rotor axis vertical in flight. A **suction** or **air driven** artificial horizon exhausts air through four **slots** which are normally half covered by four **pendulous vanes**. **Electric** artificial horizons use **levelling / mercury switches** and **torque motors**.

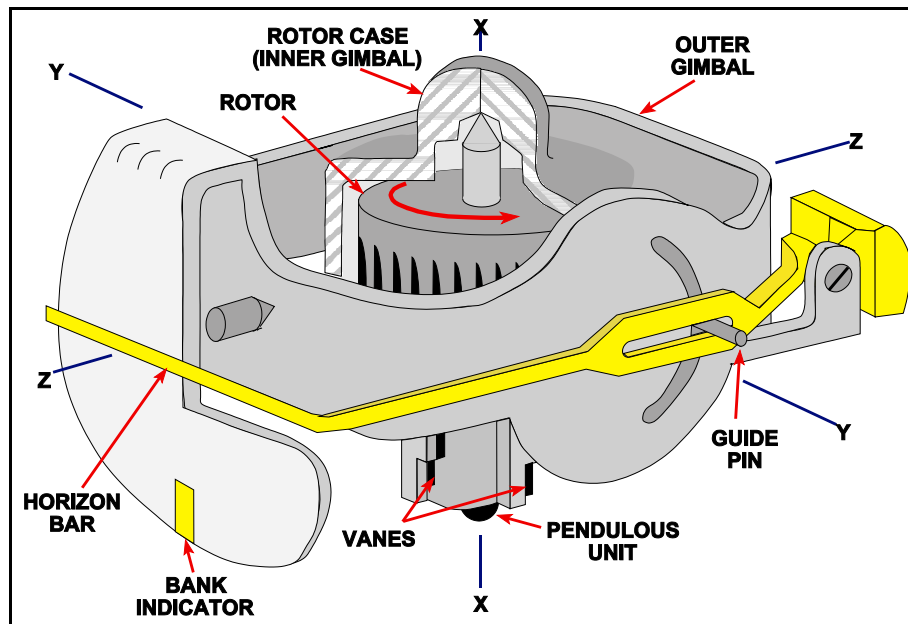

Figure 12.5 The Air Driven Artificial Horizon

THE AIR DRIVEN ARTIFICIAL HORIZON

In the air driven artificial horizon an engine-driven suction pump (or venturi tube in some light aircraft) is used to create a suction of about 4 inches of mercury in the instrument case. Replacement air, drawn in by this suction via a filter, is ducted through the outer and inner gimbals to enter the rotor case as a jet which spins the rotor at up to **15,000 rpm**. After driving the rotor, the air passes into the instrument case through slots at the base of the rotor housing.

Control System

The control system of the air driven artificial horizon consists of four slots and four pendulous (hanging) vanes at the base of the rotor housing. The vanes hang down so that when the rotor axis is vertical each slot is half covered by its vane, and four equal jets of air emerge from the slots, fore an aft and left and right, as in Figure 12.6. Because the four jets are of equal strength but in opposite directions no force is exerted on the gyro and therefore no precession occurs - the gyro rotor remaining vertical.

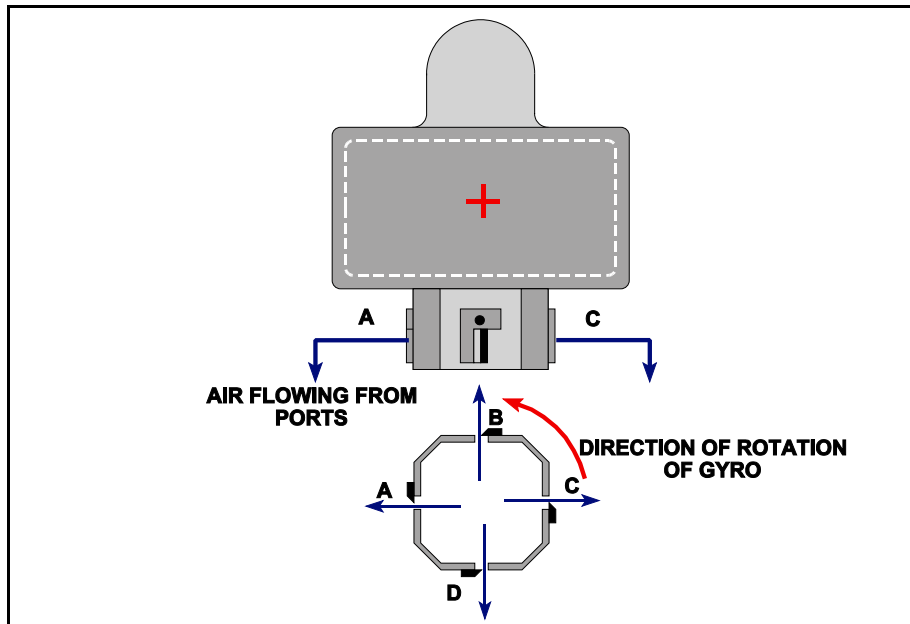

Figure 12.6 Equilibrium

However the opposing vanes are fixed to a common spindle so that the four vanes operate as two pairs. The positioning of the vanes is such that if the rotor axis wanders from the vertical, one vane will hang clear of its slot, allowing unrestricted airflow, while the opposite slot is completely obstructed by its vane. The resulting unbalanced airflow precesses the gyro and corrects the tilt, returning the gyro axis to the vertical. Exactly how this correction is achieved is shown in Figure 12.7.

The gyro has wandered from the vertical so that vanes A and C are not affected and remain half covering their slots. However, vanes B and D, on a common spindle, hang down so that slot B is now closed and D is wide open. A strong jet exits through D causing an equal and opposite reaction 'R' on the gyro. This reaction is precessed through 90° in the direction of rotor spin (anticlockwise when viewed from the top) and acts in the direction of 'P' which restores the gyro axis to the vertical.

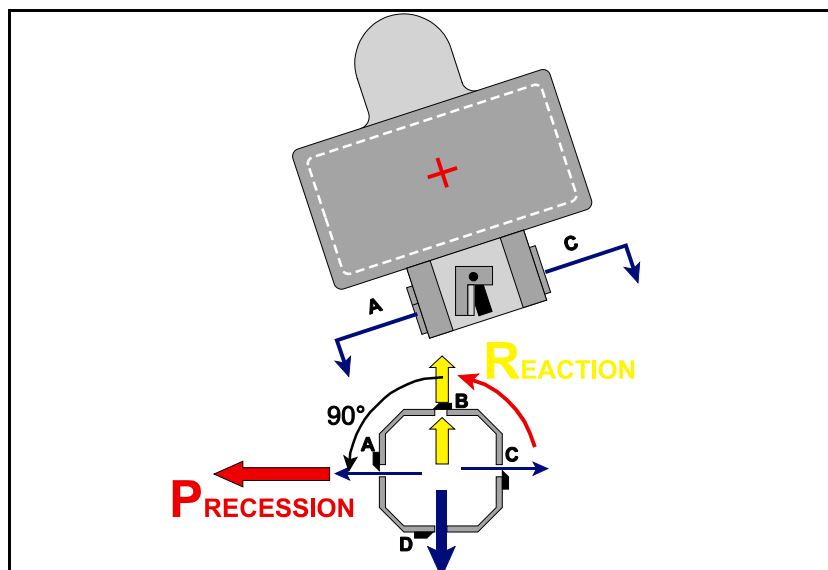

Figure 12.7 Rotor Axis Displaced from Vertical

ACCELERATION ERROR IN THE AIR DRIVEN ARTIFICIAL HORIZON

The control system of the air driven artificial horizon depends on the pendulous vanes being affected by the Earth's gravity. However, the vanes will be affected by any acceleration, not just that due to gravity.

When an aircraft **accelerates** in a level attitude (such as during the take-off run) a false nose up, right wing down, or **climbing right hand turn indication** will result. The **pitch error** is due to the effect of acceleration on the **lateral pendulous vanes**. The **roll error** is due to the inertia of the **bottom-heavy rotor housing**. These effects are now considered in more depth.

- **Pitch Error.** During acceleration, the lateral vanes lag, swinging back towards the pilot, opening the starboard slot and closing the port slot. This results in a reaction 'R' which acts to port (see Figure 12.8.) By the rule of precession the effect on the gyro is as if the direction of application of R had been moved 90° in the direction of rotor spin (anticlockwise). The gyro will now be precessed out of vertical with the base moving backwards towards the pilot. As shown in Figure 12.8., this movement is transmitted via the guide pin and horizon bar arm to bring the horizon bar below the gull-wing giving a nose-up indication.

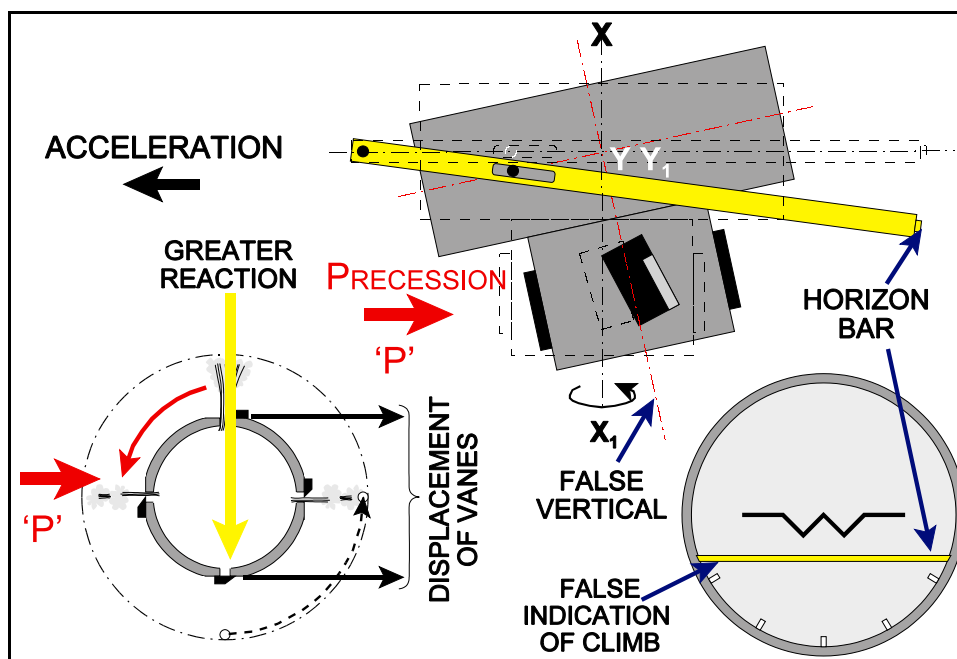

Figure 12.8 Pitch Error Due to Acceleration

- **Roll Error.** Due to inertia, the weighted base of the rotor housing tries to lag during acceleration. However, this force will be precessed, resulting in the base of the rotor housing moving to starboard and the gyro axis precessing out of the vertical (see Figure 12.9) This rotates the whole rotor / gimbal assembly about the longitudinal axis to give a right wing down indication.

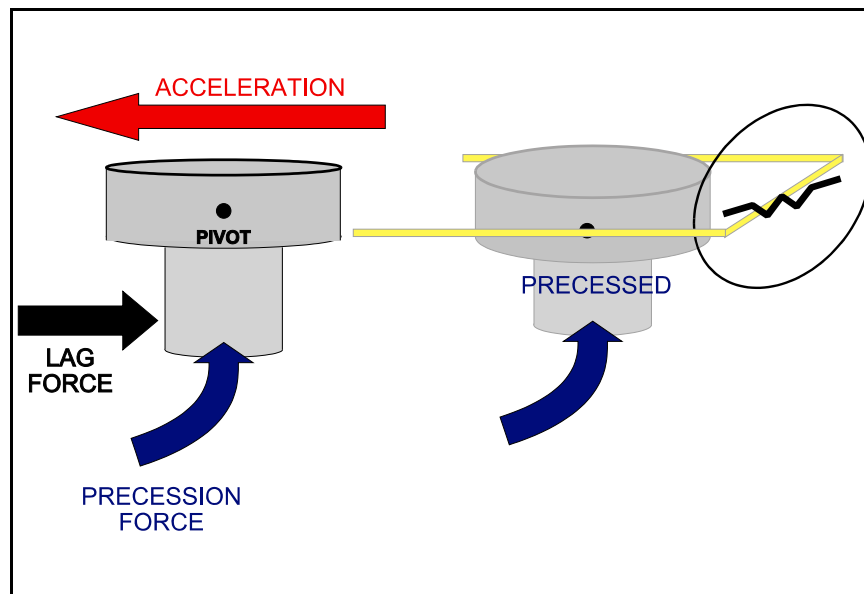

Figure 12.9 Roll Error Due to Acceleration

Deceleration will cause a nose down, left wing low error, the opposite of the acceleration error indication. These errors assume that the rotor is rotating anticlockwise when viewed from the top, which is the case for British air driven artificial horizons. Most electric horizons and some American air driven horizons have clockwise rotor spin, giving opposite errors.

TURNING ERRORS IN THE AIR DRIVEN ARTIFICIAL HORIZON

Whenever an **aircraft turns** there must be an acceleration towards the centre of the turn (centripetal force). Since the pendulous vanes are now affected by a horizontal acceleration as well as acceleration due to gravity, **errors in pitch and roll indications** will occur. During the turns the centrifugal force will act on the fore and aft pendulous vanes ('erection' error) and weighted base of the rotor housing (pendulosity' error). The errors are complex and change as the turn progresses, cancelling out after a 360° turn. The magnitude of the errors varies with speed, rate of turn, and type of horizon. For a chosen speed and rate of turn, the errors can be **compensated** for by **tilting** the top of the **rotor** axis slightly **forward** (for erection error) and slightly to the **left** (for pendulosity error).

However in an uncorrected instrument the following errors will occur. (assume a Classic Instrument - air driven with the gyro rotating anti-clockwise when viewed from above).

Turning through 90°:	Under reads bank angle	Pitch error – indicating a climb
Turning through 180°:	Bank angle correct	Pitch error – indicating a climb
Turning through 270°:	Over reads bank angle	Pitch error – indicating a climb
Turning through 360°:	Bank angle correct	Pitch angle correct

The tilts are of the order of 2°. The setting of the horizon bar has to be similarly modified to indicate correctly in level flight. Small residual errors occur, particularly if the speed and rate of turn are not those for which compensation has been applied, but the errors are very much smaller than they would be had no compensation been made.

RIGIDITY

High rotor speeds in suction horizons of up to 15,000 rpm, result in high gyroscopic inertia. With electric horizons, speeds of 22,500 rpm are typical giving even greater rigidity. Because of the high inertia, precession rates are low and therefore once a horizon topples it will take a significant period for re-erection unless a rapid erection device is fitted.

SERVICEABILITY CHECKS

Before Flight. Check that the horizon bar takes up a laterally level position with the correct pitch indication for the aircraft type, and that this indication is maintained when taxiing. If a caging device is fitted, the instrument should be uncaged at least five minutes before take-off to ensure that the rotor axis has had time to reach alignment with the true vertical.

In Flight. The artificial horizon should give an immediate and correct indication of any change in pitch or roll attitude.

THE ELECTRIC ARTIFICIAL HORIZON

The main advantage of electric artificial horizon over the air driven horizon is its greater rigidity due to its faster spin rate. This greater rigidity results in increased accuracy due to reduced errors. The basic principle of the instrument is the same as the air driven horizon. The vertical gyro is still tied by Earth's gravity, but by **mercury / levelling switches** and **torque motors** rather than the pendulous vanes of the air driven horizon.

ELECTRIC ARTIFICIAL HORIZON CONTROL SYSTEM

The gravity-operated control system consists of mercury / levelling switches (which are fixed to the base of the rotor) and electric torque motors. If a levelling switch is not level the mercury liquid ball moves from its central position and closes the circuit to drive its torque motor. The torque motor provides the force which is precessed to return the gyro axis to the vertical. There are **two levelling switches**, one to sense **pitch** and one to sense **roll**.

They activate the pitch and roll torque motors respectively which precess the gyro back to the vertical as soon as it starts to wander.

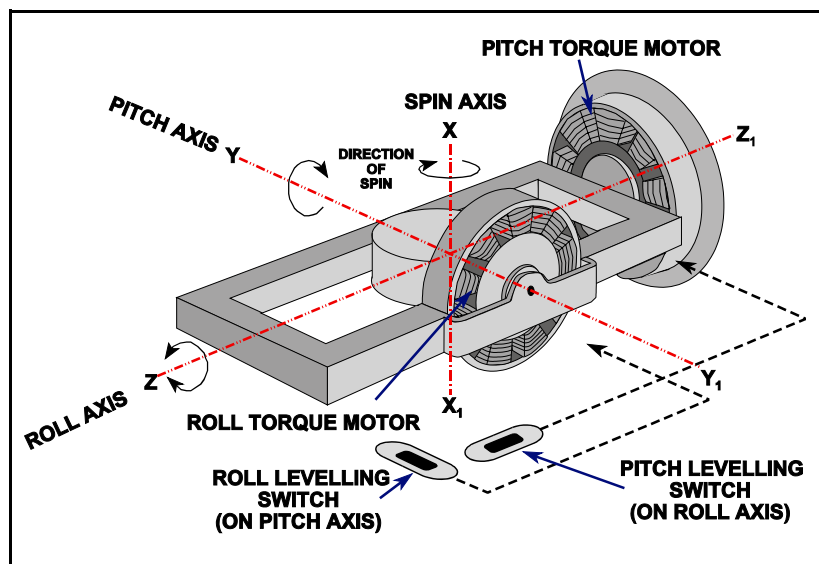

Figure 12.10 The Electric Horizon Control System

Because of the 90° precession rule, the torque motor on the side of the inner gimbal corrects wander in the rolling plane (applying torque round the lateral axis to produce rotation about the longitudinal axis). Likewise the pitch torque motor is on the outer (longitudinal) gimbal so that the precession is about the lateral axis to correct for pitch.

This control system, like that of the suction horizon, is designed to compensate for turning errors by maintaining the rotor axis slightly tilted away from the true vertical and having the horizon bar compensated by a similar amount. The amount and direction of this tilt depends on the particular model of instrument in use.

ACCELERATION ERRORS IN THE ELECTRIC HORIZON

Acceleration errors are minimal in the electric artificial horizon for the following reasons;

- The **high rotor speed** of an electric artificial horizon, results in very high gyro rigidity and therefore very low precession rates. There is therefore less potential for the gyro to move out of the Earth's vertical.
- The **rotor housing is less bottom heavy** in the electric artificial horizon and therefore roll error is reduced while accelerating.
- **Pitch and roll cut-out switches.** When an aircraft in a level attitude accelerates the pitch levelling switch will falsely complete the circuit as the mercury 'ball' moves back in its tube (due to inertia). As this would then result in the pitch torque motor falsely precessing the gyro out of the vertical, a pitch cut-out switch is included in the circuit which activates when an acceleration of 0.18G or greater is detected.
- Similarly in a turn the roll mercury switch would falsely activate the roll torque motor. A cut out is therefore incorporated in the circuit which is activated at 10 degrees angle of bank.

FAST ERECTION SYSTEM

In many electric horizons a fast erect system is included to give rapid initial erection and quick re-erection should the instrument have toppled due to exceeding the operating limits. Quoting typical figures, the normal erection rate of 4° per minute is increased to 120° per minute by pushing the fast erection knob on the face of the instrument. This action **increases the voltage** to the erection torque motors. One of the advantages of having a fast erection system is that the pendulosity (bottom-heaviness) of the gyro can be reduced, so decreasing the turning and acceleration errors.

Note: When airborne, the fast erection knob can only be used successfully in level flight with no acceleration. During acceleration or a turn, the liquid level switches would be 'off-centre', and operation of the fast-erection system would align the rotor axis with a false vertical.

ADJUSTABLE AEROPLANE DATUM

This is a refinement found on some American artificial horizons. The idea is that if when an aircraft is trimmed out to fly **straight and level** it has a pitch up attitude, the 'aeroplane' datum can be adjusted to lie on the horizon. However, there is a risk that such adjustment in flight could result in a misleading datum for flying approach procedures in IMC conditions. The Aeronautical Information Circular 14/1969 discusses this risk in depth, and strongly recommends that in **light aircraft the datum be set before flight and thereafter left well alone.** The CAA require that such movable datums be removed or otherwise rendered inoperative on aircraft having a maximum all-up weight in excess of 6000 pounds (2727 kgs).

VERTICAL GYRO UNIT

This unit performs the same functions as the Gyro Horizon, i.e. it establishes a stabilised reference about the Pitch and Roll axes of an aircraft. It is sometimes referred to as a Remote Vertical Gyro, or occasionally a Vertically Axised Data Generation Unit.

Instead of providing attitude displays by direct means, it is designed to operate a synchro system which produces, and transmits, attitude related signals to “a steering computer” and to an amplifier unit.

After processing and amplification, the signals are then transmitted to servo operated indicator elements within an Attitude Director Indicator (ADI). The synchro system also supplies attitude related signals to the appropriate control channels of an AFCS. The gyroscope and its levelling switch and torque motor system is basically the same as that adopted in electrical gyro horizons.

Whenever a change of aircraft attitude occurs, signals flow from Pitch and Roll synchros disposed about the relevant axes of the **vertical gyroscope** to the corresponding synchros within the indicator. Error signals are therefore induced in the rotors and after amplification are fed to the servo motors, which rotate to position the **pitch bar** and **horizon disc** to indicate the changing attitude of the aircraft.

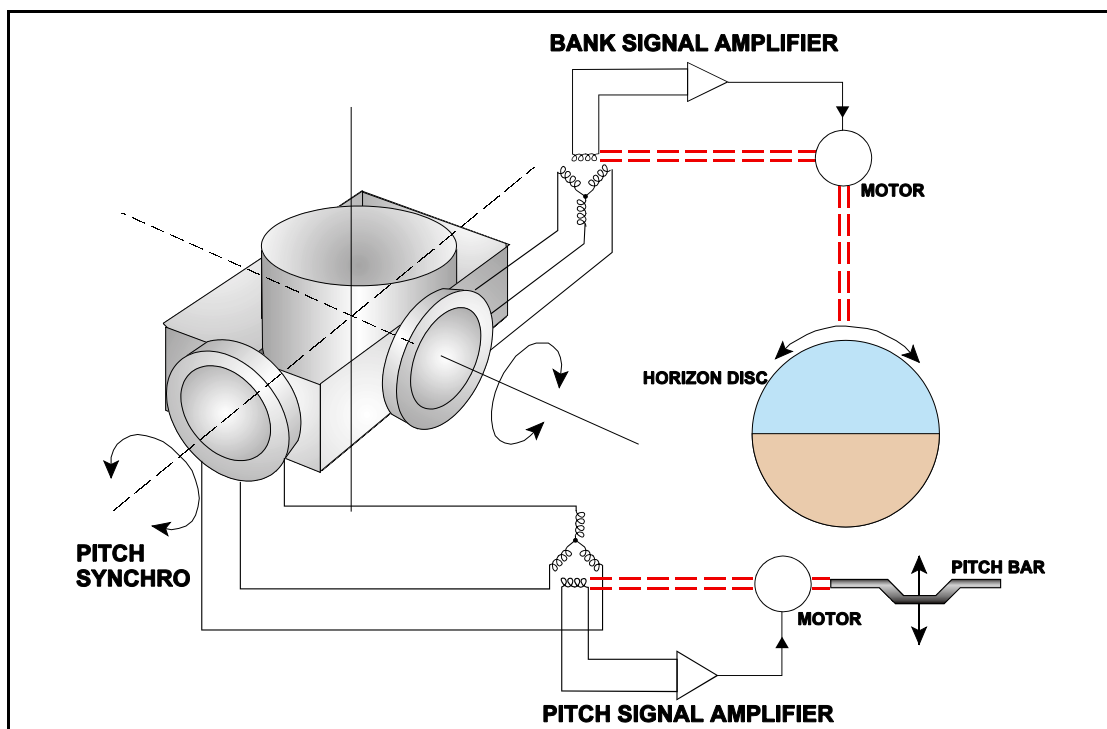

Figure 12.11 Vertical Gyro Unit

The synchro described senses changes in Pitch and Roll attitudes by means of a CX synchro positioned on each corresponding axis of the gyros’ gimbal system. The stator of the Roll synchro is secured to the frame of the unit, whilst its rotor is secured to the outer gimbal ring. The Pitch synchro has its stator secured to the outer gimbal ring, and its rotor to the inner gimbal ring. The stators supply attitude error signals to corresponding CT synchros in the ADI, and also to Pitch and Roll circuit modules of the computer.

QUESTIONS

1. An artificial horizon utilises (i)..... to show (ii)..... in (iii)..... and (iv).....
 - a. (i) an earth gyro (ii) position (iii) latitude (iv) longitude
 - b. (i) a space gyro (ii) attitude (iii) degrees (iv) minutes
 - c. (i) an earth gyro (ii) latitude (iii) pitch (iv) roll
 - d. (i) an earth gyro (ii) attitude (iii) pitch (iv) roll

2. During the take-off run an air driven artificial horizon will usually indicate:
 - a. nose up and incorrect left bank.
 - b. a false descending turn to the right.
 - c. increased nose up attitude and right wing low.
 - d. a false climbing turn to the left.

3. The indication at Figure 1 shows:

- a. a climbing turn to the right.
- b. nose-up and left wing down
- c. 30° starboard bank, nose up.
- d. 30° port bank, nose below horizon.

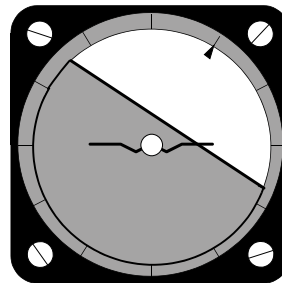

Figure 1

4. False nose-up attitude displayed on air driven artificial horizon during the take-off run is caused by:
 - a. the high pendulosity of the rotor
 - b. the lag of the lateral pendulous vanes
 - c. the linear acceleration cut out
 - d. incorrect rotor speed

5. The rotor axis of an electrical horizon is tied to the earth's vertical by:
 - a. four pendulous vanes
 - b. the roll cut out
 - c. the low centre of gravity of the rotor housing
 - d. two mercury level switches and two torque motors

6. False right wing low attitude shown on an air driven artificial horizon during an acceleration is caused by:
 - a. the lag of the base of the rotor housing
 - b. the longitudinal pendulous vanes
 - c. the roll cut-out
 - d. high rotor speed

7. Inside an artificial horizon:
 - a. the inner gimbal ring is pivoted laterally inside the outer gimbal ring and the outer gimbal ring is pivoted longitudinally inside the case
 - b. the inner gimbal ring is tied to the vertical by a control system
 - c. the rotor axis is kept level by a calibrated spring attached to the outer gimbal ring and the instrument case
 - d. there is only one gimbal ring

8. When an adjustable aircraft datum is fitted to an artificial horizon in light aircraft:
 - a. it should be checked at regular intervals
 - b. it should be set to the central position and left there
 - c. it should be rendered inoperative
 - d. it should be set to 15°

9. An electrically driven artificial horizon has less errors during the take-off run because:
 - a. it is less pendulous, has a higher rotor speed and a linear acceleration cut out
 - b. the mercury level switches are more sensitive than the pendulous vanes fitted to air driven types
 - c. the roll cut-out speed is activated
 - d. it is less aperiodic than the air driven types

ANSWERS

- | | |
|---|---|
| 1 | D |
| 2 | C |
| 3 | D |
| 4 | B |
| 5 | D |
| 6 | A |
| 7 | A |
| 8 | B |
| 9 | A |

CHAPTER THIRTEEN

THE TURN AND SLIP INDICATOR

Contents

THE RATE OF TURN INDICATOR181
THE RATE GYRO181
OPERATION181
CONSTRUCTIONAL DETAILS182
EFFECT OF VARYING ROTOR SPEED183
ERRORS IN THE LOOPING PLANE183
THE SLIP INDICATOR183
CONSTRUCTION183
OPERATING PRINCIPLES183
TURN AND SLIP DISPLAYS185
QUESTIONS187
ANSWERS188

THE RATE OF TURN INDICATOR

This instrument incorporates two measuring devices, both indicating on the same instrument face. One of these, the rate of turn indicator, (commonly shortened to 'turn' indicator), uses a rate gyro to measure rate of turn about a vertical axis. The other, the slip indicator, is a very simple pendulous device which is used mainly to show whether or not a turn is balanced, (whether the angle of bank is correct for the TAS and rate of turn), and if not, to indicate the extent of slip or skid.

THE RATE GYRO

The turn indicator is based on a horizontal-axis rate gyro, which has only one gimbal and therefore only one degree of freedom. If the aircraft banks (without turning) the gyro axis has the freedom to remain horizontal. However, if the aircraft yaws, the frame, fixed to the airframe, applies a force (labelled primary torque) in Figure 13.1, in a direction where the gyro is not gimbaled, and therefore has no freedom. This results in a precession which will cause the gyro to depart from the horizontal. A spring system prevents the gyro from turning all the way to the vertical, and the amount of spring stretch is a measure of the rate of turn.

OPERATION

Figures 13.1 and 13.2 illustrate the principal of operation. If the aircraft turns, the rotor is subjected to a primary torque acting about the ZZ axis. This produces a primary precession about the YY axis, the direction of this precession being as if the applied force were moved 90° in the direction of rotor spin. As the rotor tilts about the YY axis it causes a spring between gimbal and frame to be extended. The resultant spring tension subjects the rotor to a secondary torque acting about the YY axis. This secondary torque, with the precession will continue until the gimbal has tilted just the right amount to give the spring tension required to generate a rate of secondary precession equal to the rate of turn of the aircraft. This gives equilibrium. It should be emphasised that the chain of events is virtually instantaneous - as the aircraft goes into a turn, the gimbal takes up the appropriate angle of tilt.

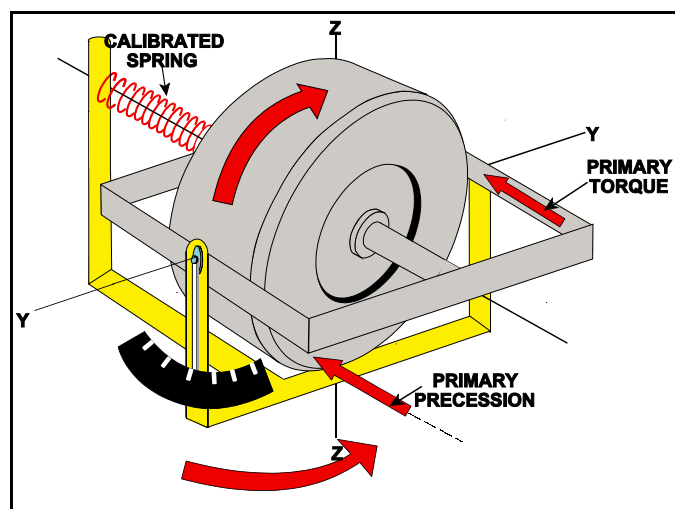

Figure 13.1

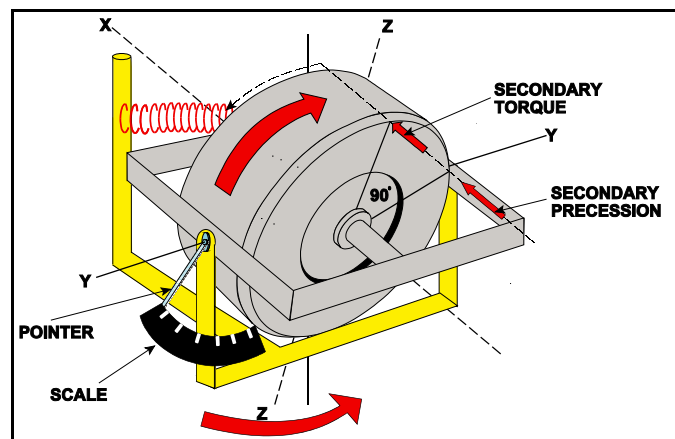

Figure 13.2

If the rate of turn changes, the tilt of the gimbal will also change, to re-establish the balance of torques on the gyro. The angle of tilt is thus a measure of the rate of turn. A pointer fixed to or linked with the gimbal indicates the tilt on a scale on the face of the instrument. The scale is calibrated to indicate rates of turn either side of the centre zero so that the first graduation corresponds to a Rate 1 turn with the aircraft turning 3° per second. A second mark for Rate 2 corresponds to 6° per second. There may be further graduations for higher rates of turn.

Calibration of correct rate of turn (the spring tension) is optimised for a design TAS.

However, only a small amount of error is introduced, even for quite large departures from design TAS.

In practice the errors produced by TAS deviations are not serious. One manufacturer quotes a maximum error of 5% over a speed range of 85 to 350 knots, the calibration value being 260 knots.

CONSTRUCTIONAL DETAILS

Suction and electrically-driven types are available. With the former, an engine-driven pump or venturi tube is used to apply suction to the case. Replacement air enters via a filter and is directed by a jet at the 'buckets' cut in the periphery of the rotor. The rotor rpm are low compared with those of the DGI and artificial horizon. This is because the gyroscopic property of precession is used to measure rate to turn, so that a high gyroscopic rigidity is undesirable. A damping system fitted to the gimbal reduces oscillation. This may be the piston-in-cylinder type or an electro-magnetic device. Stops limit the movement of the gimbal to tilt corresponding to a turn of about 20° per second.

Notes: *As there is only one gimbal, the gyro will not 'topple' when it comes against the stops.*

The warning flag on the face of the TBI indicates that electrical power to the instrument has failed.

EFFECT OF VARYING ROTOR SPEED

If the suction is inadequate (at high altitude, or with a choked filter, or a leaking suction tube) with an air-driven instrument, gyro rigidity will be lowered as the gyro is “underspeeding”. Consequently the secondary precession needed to equal the aircraft turn can be generated by a smaller secondary torque. This reduced torque will be produced by a smaller angle of gimbal tilt, and this means that the instrument will **under-read** the turn rate.

Alternatively, if the gyro were to “overspeed”, by the same token it will **over-read** the rate of turn that is being achieved by the angle of bank applied.

ERRORS IN THE LOOPING PLANE

In a gently banked turn, the aircraft is turning mainly in the yawing plane, but in a steep turn there is more movement in the looping plane. Normally movement in the looping plane means that the aircraft is rotating about the rotor axis, with no effect on the gyro. However, if the gimbal is tilted before movement in the looping plane commences, as happens with a yaw, the movement in the looping plane will cause additional precession of the rotor.

The usual positive movement in the looping plane in a steep turn will increase the gimbal tilt causing the indicator to **over-read**, sometimes coming against the stops.

THE SLIP INDICATOR

It is desirable that turns should be properly balanced, with no side slip or skid. This implies that the angle of bank should be correct for the TAS and rate of turn. The correct bank angle could be accurately calculated, or rules of thumb may be used. For instance, with Rate 1 turns, we can take one tenth of the TAS and add seven to give approximately the required bank angle. For example; Rate 1, TAS 150 knots; bank angle should be $15 + 7 = 22^\circ$. This rule gives reasonable accuracy for Rate 1 turns with TAS between 100 and 250 knots. During instrument flight however, the fewer the calculations that have to be made, the better. The slip indicator gives a direct indication of the state of balance of the turn.

CONSTRUCTION

Early types of slip indicator employed a simple metal pendulum suspended in the instrument case, its oscillations being controlled by a piston-in-cylinder damping device. The modern version is usually a ‘ball-in-tube inclinometer’. This comprises a solid ball in a curved tube containing liquid with damps out the unwanted oscillations. It is sketched in Figures 13.3b. and 13.4b. The heavy ball behaves like a pendulum, with the centre of curvature of the tube acting as the effective point of suspension.

OPERATING PRINCIPLES

Consider first the aircraft in level flight with lift L balancing weight W viewed in Figure 13.3a. The weight W of the ball in the tube acts downwards and is exactly balanced by the equal and opposite reaction of the base of the tube on the ball, acting upwards towards the centre of curvature of the tube. If the wings are level, the ball will lie just between the two vertical lines etched on the tube, as indicated in Figure 13.3b..

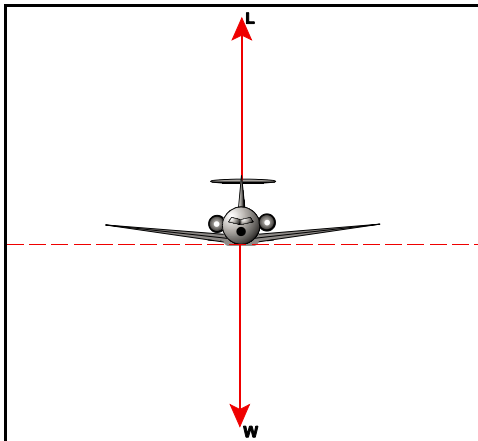

Figure 13.3a
Aircraft in Level Flight

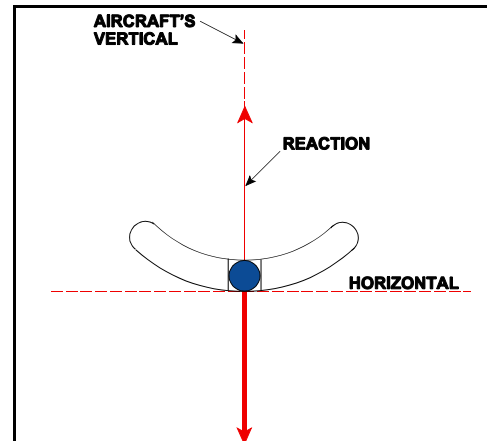

Figure 13.3b
Ball-in-tube (Level Flight)

Now let us consider a balanced turn to the left. Figure 13.4a. shows the aircraft with lift L equal and opposite to the resultant of aircraft weight W and centrifugal force C , the latter being proportional to TAS and rate of turn.

The ball is also subject to a centrifugal force depending on TAS and rate of turn, so it rolls outwards, taking up a new equilibrium position such that the reaction of the base of the tube on the ball is again exactly balanced, this time by the resultant of ball weight W and centrifugal force C (Figure 13.4b)

Because both aircraft and the ball are experiencing the same TAS and rate of turn (and so the same acceleration towards the centre of the turn) it can be proved that the resultant weight and centrifugal force for the aircraft will be parallel to the resultant of weight and centrifugal force for the ball. Now if the ball is laterally central in the tube, (between the two etched lines), the resultant and reaction forces of the ball must lie in the aircraft's vertical (see Figure 13.4b). These forces are parallel, as stated above, to the resultant of aircraft weight and centrifugal force with must therefore also lie in the aircraft's vertical and will thus be in the same line as the lift L (Figure 13.4a) - which means that the turn is balanced.

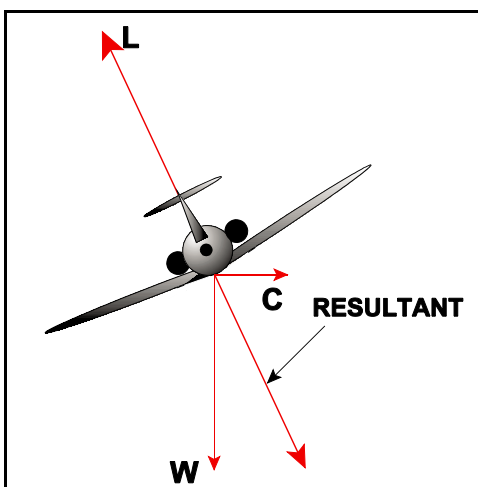

Figure 13.4a
Balanced Turn To Port

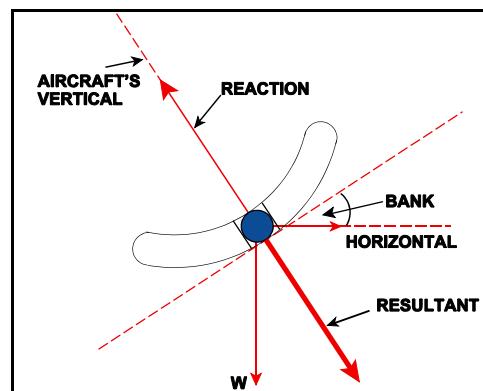

Figure 13.4b
Ball-in-Tube (Balanced Turn Port)

Unbalanced turns are most simply considered as follows. Let us assume that the TAS and rate of turn are the same as in Figures 13.4a and 13.4b, so that the ball will not have moved laterally. Now if too much bank is applied, (for the TAS and rate of turn), the tube will have been rotated too far in the rolling plane so that the ball appears as in Figure 13.5., no longer central, but correctly indicating the aircraft to be 'slipping in' to the turn, the radius of which will be less than it should be. If on the other hand insufficient bank has been applied, the instrument will be indicating that the aircraft is 'skidding out' of the turn (see Figure 13.6), the radius of turn this time being greater than it should be.

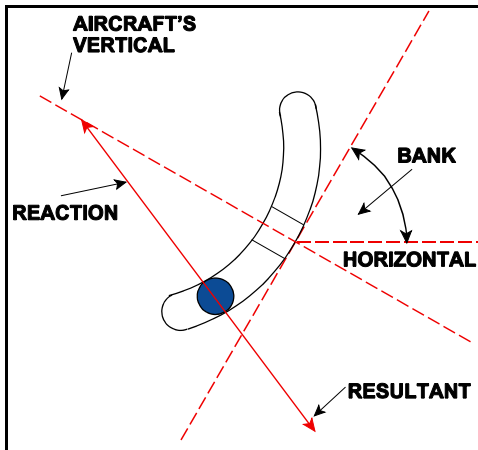

Figure 13.5
Unbalanced Turn Port (Slipping)

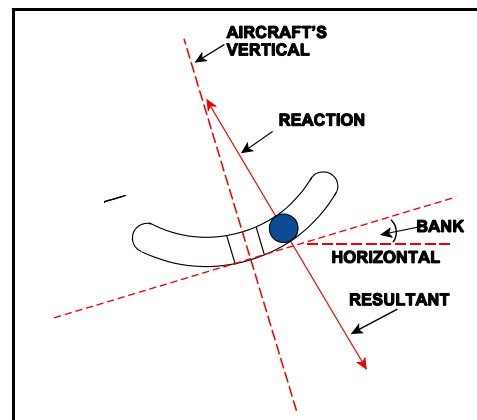

Figure 13.6
Unbalanced Turn Port (Skidding)

TURN AND SLIP DISPLAYS

Several examples of turn and slip indications (needle and ball type) are drawn in Figure 13.7.

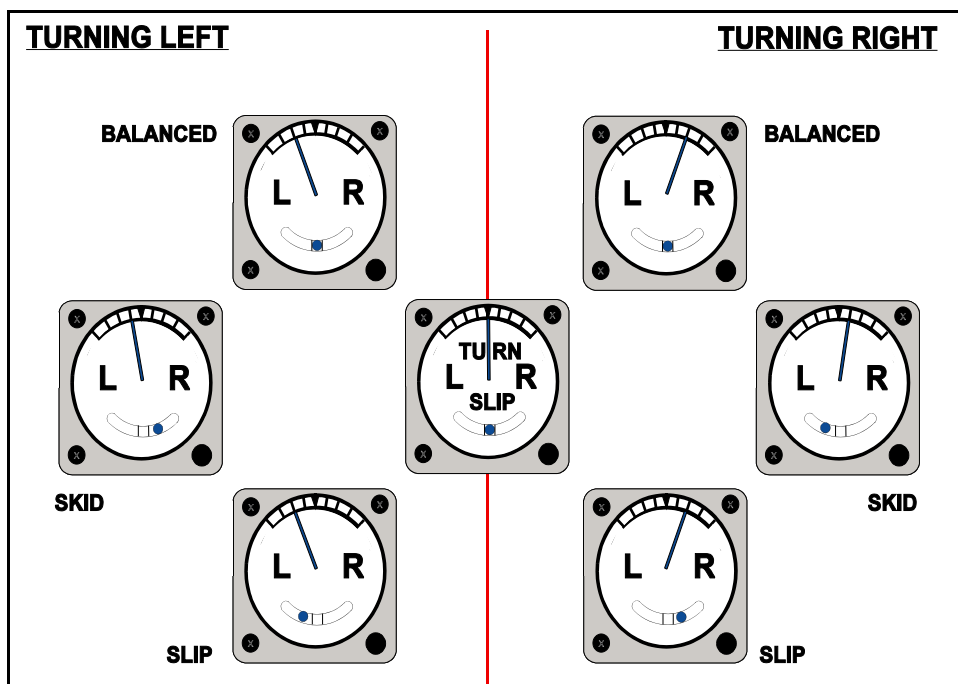

Figure 13.7 Needle and Ball Displays

Example Question - Rate one turn

Flying at 360 kts what is the turn diameter at Rate 1?

1. A rate 1 turn takes 2 minutes to complete, therefore.....
Flying at 360 kts each minute you will fly 6nms and so..... in 2 minutes you will cover 12nms.
2. The circumference of a circle = $\pi \times d$ (diameter of a circle)
3. The circumference is 12nms, therefore
 $12 = 22/7 \times "d"$
or
 12×7 divided by $22 = d$
 $3.8 = d$
4. To check we can divide 360 by 100 = 3.6 ----- 4 "nms"
similarly for 400 = "4nms"
and for 500 = "5nms"

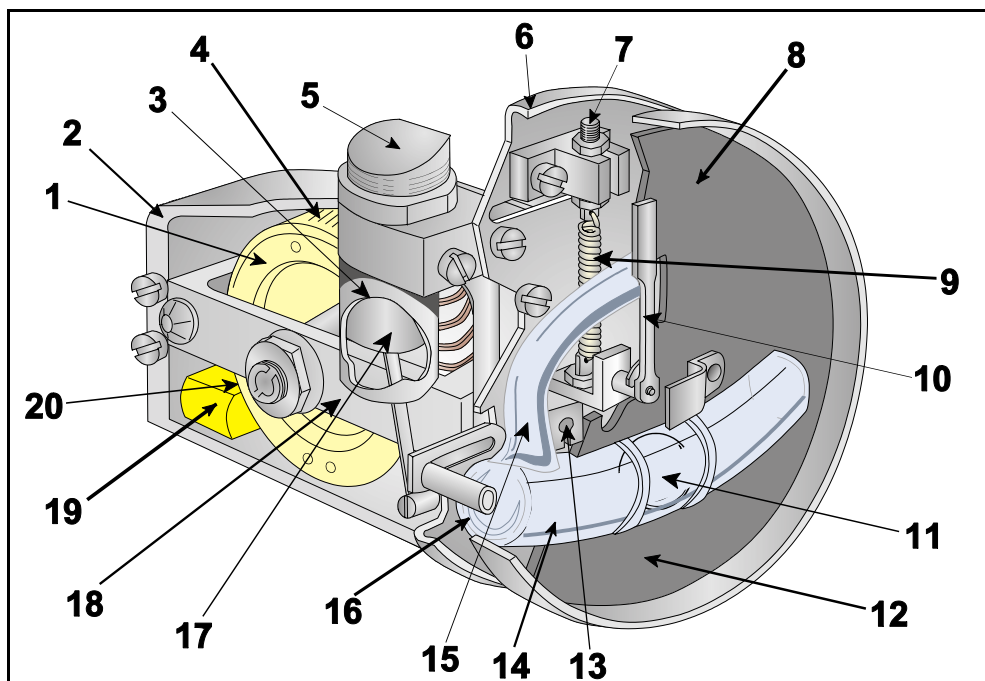

Figure 13.8 Mechanism of an air-driven turn-and-bank indicator

- | | |
|--------------------------------|------------------------|
| 1. Rotor | 11. Agate ball |
| 2. Instrument frame | 12. Datum arrow |
| 3. Damping cylinder | 13. Gimbal front pivot |
| 4. Buckets | 14. Slip indicator |
| 5. Air bleed | 15. Expansion chamber |
| 6. Front plate | 16. Fluorescent card |
| 7. Rate-spring adjusting screw | 17. Piston |
| 8. Dial | 18. Gimbal ring |
| 9. Rate spring | 19. Jet block |
| 10. Pointer | 20. Jet |

QUESTIONS

1. The rate of turn indicator uses (i) which spins (ii).....
 - i
 - ii
 - a. space gyroscope up and away from the pilot
 - b. tied gyro anti-clockwise when viewed from above
 - c. rate gyro up and away from the pilot
 - d. earth gyro Clockwise

2. The gyro in a rate of turn indicator has (i) operating speed than the gyros used in other instruments because (ii).....
 - i
 - ii
 - a. lower a higher rigidity is not required
 - b. the same it uses the property of rigidity
 - c. a higher a low precession rate gives a greater operating range
 - d. variable more than one rate of turn is desired

3. The TBI shown alongside indicates:
 - a. a rate of turn to the left, slipping in
 - b. an aircraft taxiing and turning starboard
 - c. that the aircraft will complete a turn in one minute
 - d. the aircraft is yawing to the right

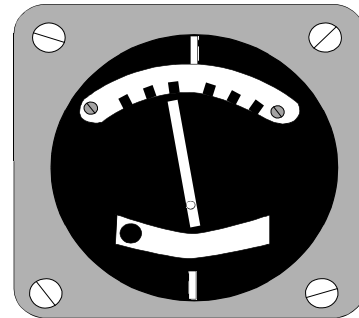

ANSWERS

- 1 C
- 2 A
- 3 A
- 4 D
- 5 A
- 6 D

CHAPTER FOURTEEN
THE TURN CO-ORDINATOR

Contents

TURN CO-ORDINATOR191
QUESTIONS192
ANSWERS192

TURN CO-ORDINATOR

The **Turn Co-ordinator** is an interesting development of the **Turn** and **Bank** indicators.

The primary difference is in the setting of the precession axis of the rate gyroscope and the method of display.

The gyroscope is spring restrained and is mounted so that the axis is at about 30 degrees with respect to the aircraft longitudinal axis, thus making the gyroscope sensitive to banking of the aircraft as well as to turning.

A turn is normally initiated by banking the aircraft, the gyroscope will precess, and this in turn will move the aircraft symbol in indicate the direction of bank and enable the pilot to anticipate the resulting turn.

The pilot then controls the turn at the required rate by alignment of the aircraft with the graduations on the instrument dial. The rate of turn will depend on the instrument in use either as a rate one turn, 3 degrees per second, or any other rate dependant on instrument design. The ball still has to remain central for a balanced rate of turn.

The annotation “No Pitch Information” on the indicator scale is given to avoid any confusion in pitch control which might result with the similarity with the presentation of the gyro horizon.

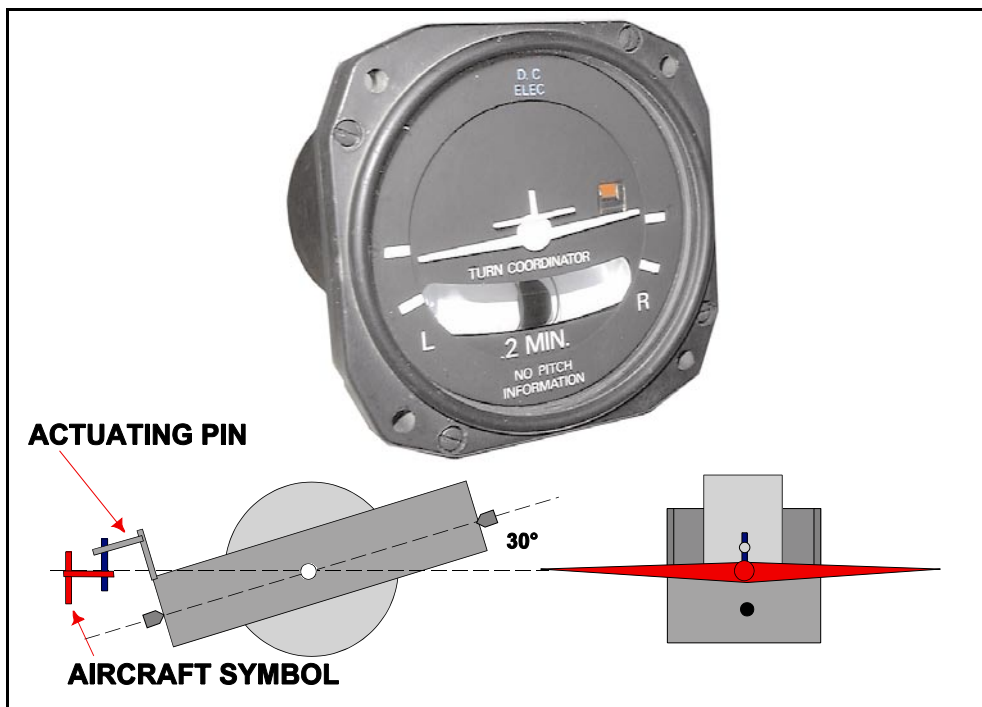

Figure 14.1

QUESTIONS

1. The gimbal ring of a turn co-ordinator is inclined at about 30° with respect to the aircraft's longitudinal axis in order:
 - a. make the rate of turn more accurate
 - b. make the gyro sensitive to banking of the aircraft as well as to turning
 - c. make the gyro more effective during inverted flight
 - d. have a higher rotor speed which will prolong the life of the instrument

2. If an aircraft turns as indicated in Figure 1:
 - a. the aircraft will turn through 180° in two minutes
 - b. it will take one minute to turn through 90°
 - c. the aircraft is turning left at less than $3^\circ/\text{second}$
 - d. the aircraft is turning left at $3^\circ/\text{second}$

3. A turn co-ordinator has (i) pivoted (ii) in the case

	i	ii
a.	two gimbal rings	orthogonally
b.	a single gimbal ring	longitudinally
c.	one gimbal ring	laterally
d.	two gimbal rings	mutually perpendicular

ANSWERS

1. B 2. C 3. B

CHAPTER FIFTEEN
AIRCRAFT MAGNETISM

Contents

DEVIATION195
COMPASS SWING195
HARD IRON MAGNETISM196
SOFT IRON MAGNETISM196
CORRECTION OF COEFFICIENTS199
ACCURACY LIMITS199
CHANGE OF MAGNETIC LATITUDE200
OCCASIONS FOR SWINGING THE COMPASS201
QUESTIONS202
ANSWERS204

DEVIATION

The compass needle would accurately define the magnetic meridian were it not for the aircraft's own internal magnetism deflecting it. Deviation is the angular difference measured between the direction taken up by a Compass Needle and the Magnetic Meridian. Deviation is named Easterly or Westerly depending on whether the North seeking end of the compass needle lies to the East or West of the Magnetic meridian.

	Compass Heading	Deviation	Magnetic Heading
Deviation West Compass Best	095	-5	090
Deviation East Compass Least	090	+5	095

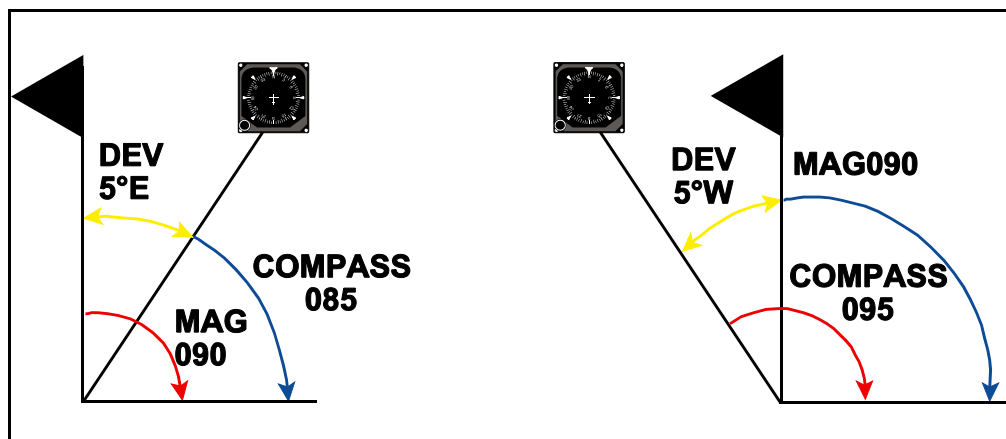

Figure 15.1

COMPASS SWING

The basic method of determining deviation is to compare the aircraft's heading compass reading with magnetic heading as defined by a high quality 'land or datum' compass. This comparison of aircraft compass and magnetic datum readings is carried out in an area selected specifically for this purpose.

Therefore the aims of a compass swing are as follows:

- To observe / determine the deviations / differences between Magnetic North (observed on a Landing Compass) and Compass North (observed in the aircraft) on a series of headings
- To correct / remove as much deviation as possible
- To record the residual deviation which is left after the Compass has been adjusted

The magnetic deviation observed during a compass swing can be said to be derived from Hard Iron and Soft Iron magnetism and this total field can in turn, for our purposes, be later resolved into two further combined components (coefficients B and C).

HARD IRON MAGNETISM

The total force at the compass position produced by permanent hard iron magnetism can be resolved into three components. These components will be fixed for a given aircraft and will not change with change of heading.

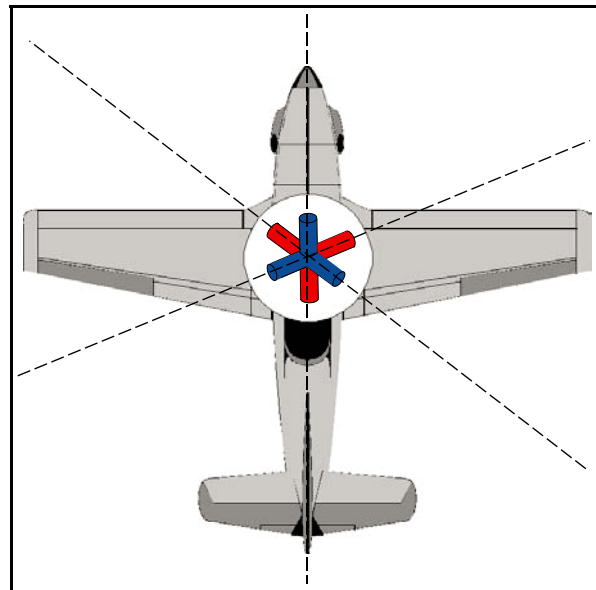

Figure 15.2

SOFT IRON MAGNETISM

Soft iron magnetism is induced in parts of the aircraft structure by surrounding fields - the most important of these being the earth. The earth's field has a vertical as well as horizontal component. However, again for our purposes we will within the constraints of the syllabus only consider vertical soft iron (VSI) magnetism (Z is the vertical component of the earth's field and H is the horizontal component). The component Z has an increasing affect with latitude as the compass magnets try to follow the earth's flux lines therefore VSI magnetism must also vary with latitude. However, Z is zero at the equator, where the horizontal component H is greatest, so no VSI magnetism is induced there.

When we examine the effective positioning of the imaginary magnets found when completing a compass swing we must remember that we use a real system (the Compass) to give us aircraft heading and that this readout is affected by these magnetic forces which we have gone to some trouble to discover.

We can see from Figure 15.3 that the positioning can vary, (even to the extent of having two imaginary magnets affecting our compass) but the effect will be easily resolved by the compass swing which can cater for any positioning as long as we follow the basic rules.

For example we may examine the case where the effect of the Blue Pole is said to be in the nose or forward of the aircraft compass.

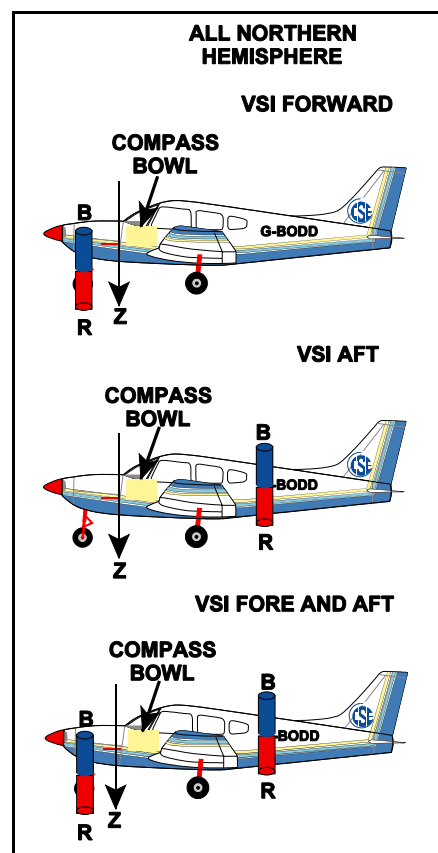
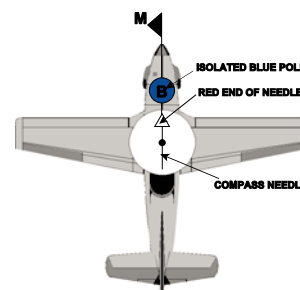

Figure 15.3

Heading North the isolated Blue pole is in the same horizontal direction as the earth's blue pole and so the needle is not deviated. The directive force or alignment of the earth's field is being augmented by the blue pole, effectively they are pulling together.

As the aircraft now turns right on to 045° deviation begins to take place and as we can see from the table by 090° this has become maximum and then starts to become less as we approach 180°.



Hdg C 000°

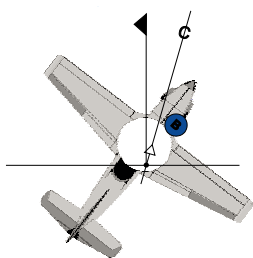

Hdg C 045°

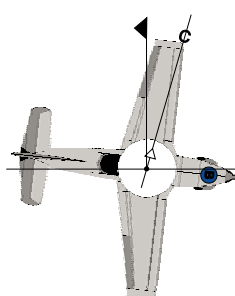

Hdg C 090°

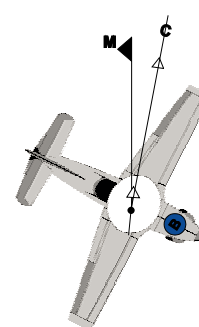

Hdg C 135°

Remember that the blue pole represents a magnetic force which on this heading acts along the same line but in opposition to the stronger earth's field.

On the remaining headings 180° to 360° the effects of the blue pole in the nose are as expected i.e. the red end of the compass needle is being attracted to the West of Magnetic North giving the maximum westerly deviation on 270°.

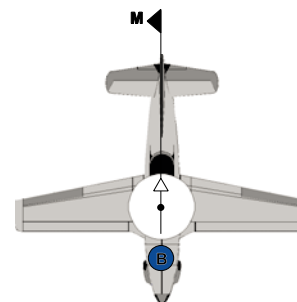

Hdg C 180°

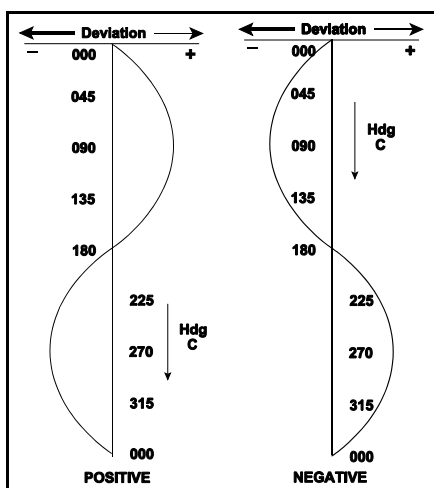

If the deviations caused by the blue pole in the nose are plotted against compass heading, a positive sine curve is obtained. Had the blue pole been aft of the compass a negative sine curve would have been obtained. This would mean that on a heading of 090° the deviation would reach a maximum westerly value instead of a maximum easterly value. The changes in directive force would also be revised, the maximum occurring on 180° and the minimum on 360°.

Figure 15.5

Heading °C	Deviation	Directive Force
000	Zero	Maximum
045	East + some	More than earth's
090	East + max	Earth's approximately
135	East + some	Less than earth's
180	Zero	Minimum
225	West - some	Less than earth's
270	West - max	Earth's approximately
315	West - some	More than earth's
000	Zero	Maximum

What we have examined here is known for compass swinging as Coefficient B which we could view as that component which is resolved along the body of the aircraft. The forces resolved follow a simple Sine Curve which in our case here would be 'positive' although negative curves occur just as frequently.

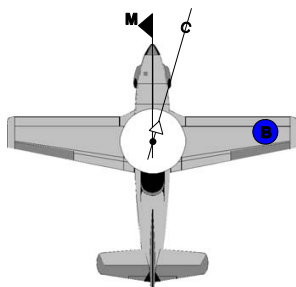
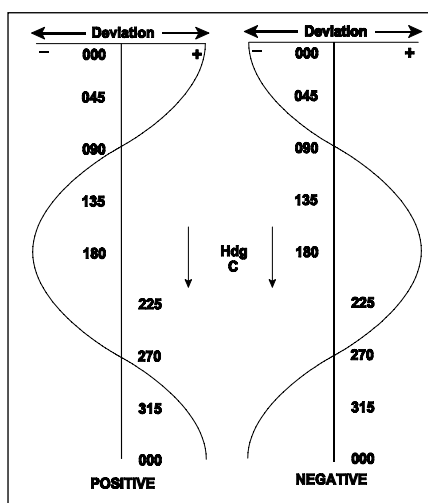

Figure 15.6a

Equally we should be able to see that if a further magnetic source is resolved to the right wing we would achieve a positive cosine curve which is more usually described as Coefficient C.



The combination of Coefficients A (a mechanical function yet to be discussed) + B + C are resolved during the compass swing and to some extent can be removed by adjustment but other factors are at work here and will probably leave us with some errors at the end.

Figure 15.6b

CORRECTION OF COEFFICIENTS

The principle for correcting coefficients is the same for any system and can be summed up as follows:

Coefficient A - a mechanical problem of a displaced Lubber Line corrected by loosening the bolts holding the compass body or in the case of the RIMC the Detector Unit and carefully turning it until the correct heading is in place.

Coefficient B - correction required because of magnetic deviating forces acting upon the DRMC or the detector Unit and giving errors known as deviation. Firstly calculate the error to be removed or more correctly the heading you wish to make the compass read and this will be done on an Easterly or Westerly heading.

Coefficient C - correction required because of magnetic deviating forces acting upon the DRMC or the detector Unit and giving errors known as deviation. Firstly calculate the error to be removed or more correctly the heading you wish to make the compass read and this will be done on a Northerly or Southerly heading.

We can see that the correction for B and C are very similar but that we must remember to apply the sign of the correction properly to ensure an accurate correction to our compass system. When the compass swing is completed we of course have to check our work and this 'check swing' is carried out using eight or perhaps twelve points of the compass to allow us to derive a compass card that will be placed in the aircraft. This compass card indicates to us the residual deviations that we have been unable to resolve within the essentially horizontal procedure. Alternatively, the Residual Deviations affecting the compass after the completion of a compass swing may be shown by the use of a Graphical Table or a Curve constructed from the information obtained. Either set of calculations will allow for the placing of a Compass Deviation Card near to the compass in the aircraft.

ACCURACY LIMITS

In accordance with CS Ops-1 (European Regulations) the aircraft's compasses must, after correction, be within the following limits:

Direct Reading Magnetic Compass +/- 10°

Remote Indicating Compass +/- 1°

CHANGE OF MAGNETIC LATITUDE

$$\text{Tan Dip} = \frac{Z}{H}$$

The changes in deviation due to change of magnetic latitude have to be considered firstly with regard to Hard Iron and secondly to Vertical Soft Iron.

Hard Iron. The hard iron deviating force, remains constant regardless of change of latitude. However, H varies with latitude being maximum at the equator and zero at the poles. Thus the smaller the directive force H the greater the maximum deviation, caused by hard iron deviating force. Hard iron deviating effect increases towards the poles and is minimum at the magnetic equator. The sign of the deviation will be the same in both hemispheres.

To summarise, maximum deviation due to hard iron magnetism, is inversely proportional to the value of H, which changes with change of magnetic latitude.

Vertical Soft Iron. The directive force at the compass position is H, whilst the magnetising agent of any VSI component is Z. The maximum deviation due to VSI magnetism will vary inversely as H.

The VSI maximum deviation will vary directly as Z. Z has no effect on Hard Iron deviation. The maximum deviation produced by VSI magnetism increases towards the magnetic poles.

$$\text{Max deviation} = \frac{Z}{H} = \text{Tan Dip}$$

so maximum deviation varies directly with Tan dip.

OCCASIONS FOR SWINGING THE COMPASS

- When compass components are installed or replaced.
- Whenever the accuracy of the compass is in doubt.
- After a maintenance inspection if required by the schedule.
- After a significant aircraft modification, repair or replacement involving magnetic material.
- When carrying unusual ferromagnetic payloads!
- When the compass has been subjected to significant shock.
- If the aircraft has been struck by lightning.
- After significant modification to aircraft radio/electrical systems.
- After the aircraft has been given a new theatre of operations if the move involves a large change of magnetic latitude.
- If the aircraft has been in long term storage standing on one heading.

QUESTIONS

1. European regulations (CS Ops-1) state that the maximum permissible deviations after compensation are:
 - a. one degree for a remote indicating compass, and ten degrees for a direct reading magnetic compass.
 - b. three degrees for a direct reading magnetic compass, and one degree for a remote indicating compass.
 - c. ten degrees for a remote indicating compass, and one degree for a direct reading magnetic compass.
 - d. one degree for a direct reading magnetic compass, and eleven degrees for a slaved compass.

2. Compass swings should be carried out:
 - a. on the apron.
 - b. only on the compass swinging base or site.
 - c. at the holding point.
 - d. on the active runway.

3. Aircraft magnetism caused by Vertical Soft Iron:
 - a. varies with magnetic heading but not with magnetic latitude.
 - b. varies with magnetic latitude but not with heading.
 - c. it is not affected magnetic latitude or heading.
 - d. varies as the cosine of the compass heading.

4. Aircraft magnetism caused by Hard Iron:
 - a. is not usually influenced by the earth's magnetic field.
 - b. varies directly with magnetic latitude.
 - c. varies indirectly with magnetic latitude.
 - d. is maximum on east and west.

5. The aim of a compass swing is:
 1. to find deviation on the cardinal headings and to calculate coefficients A, B and C.
 2. to eliminate or reduce the coefficients found.
 3. to record any residual deviation and to prepare a compass correction card.
 - a. only answer 1 is correct.
 - b. answers 1 and 3 are correct.
 - c. answers 1, 2 and 3 are all correct.
 - d. none of the above answers are correct.

6. Deviation due to coefficient A is mainly caused by:
 - a. hard iron force acting along the longitudinal axis.
 - b. hard and soft iron forces acting along the lateral axis.
 - c. vertical soft iron forces.
 - d. a misaligned lubber line.

ANSWERS

- 1 A
- 2 B
- 3 B
- 4 A
- 5 C
- 6 D

CHAPTER SIXTEEN

REMOTE INDICATING MAGNETIC COMPASS

Contents

LIMITATIONS OF THE DIRECT READING COMPASS207

LIMITATIONS OF THE DIRECTIONAL GYRO INDICATOR207

REQUIREMENT FOR THE GYRO-MAGNETIC COMPASS207

BASIC SYSTEM DESCRIPTION207

OPERATION WITH STEADY HEADING – CORRECTION FOR GYRO DRIFT208

OPERATION IN A TURN – GYRO DRIFT SMALL OVER PERIOD OF TURN.209

RAPID SYNCHRONISATION209

DETECTOR UNIT (FLUX VALVE).210

ERROR SIGNAL COMPARISON.214

HEADING INDICATOR214

OPERATION AS A DGI215

ANNUNCIATOR.215

KEEPING THE GYRO AXIS HORIZONTAL216

TRANSMITTING HEADING OUTPUT TO OTHER INSTRUMENTS.216

OTHER FACILITIES (NOT FOUND IN ALL GM COMPASSES).217

SUMMARY220

QUESTIONS221

ANSWERS222

LIMITATIONS OF THE DIRECT READING COMPASS

The Direct Reading Compass has three major limitations:

- **Turning and acceleration errors.** The compass cannot be read accurately during a turn.
- The **magnetic sensing element** (the magnets on the vertical card) is contained within the instrument and is therefore situated close to the pilot so that the card can be seen. The cockpit area **is close to sources of deviation**, such as electric lights, electric motors and ferrous metal.
- The instrument is self-contained. **It is not possible to take a magnetic heading and input it into other equipment.**

LIMITATIONS OF THE DIRECTIONAL GYRO INDICATOR

The **Directional Gyro Indicator** attempts to solve some of these problems by use of an air-driven or an electro-mechanical gyro. Turning and acceleration errors are eliminated and an output can be taken to other equipment. However, there is **no magnetic input**, so **if the gyro drifts with time there is no correction** except by the pilot manually synchronising to the direct reading compass at regular intervals.

REQUIREMENT FOR THE GYRO-MAGNETIC COMPASS

What is required is a system which **combines the best of both**. The **short-term rigidity of the gyro** overcomes turning and acceleration errors. This needs to be combined with the **longer-term monitoring of the Earth's magnetic field** so that if the gyro starts to drift, a servo system slaves it to alignment with a magnetic input. Such a system is a **gyro-magnetic compass**.

The gyro-magnetic compass is known by several names. It can be referred to as the:

- **Gyro-magnetic compass.**
- **Remote Indicating Compass.**
- **Slaved Gyro compass.**
- **Magnetic Heading Reference System (MHRS)**

They all mean the same thing.

BASIC SYSTEM DESCRIPTION

At its simplest, the system comprises the following elements:

- **Magnetic Detector Unit.** This is also often known as a **flux valve** or a **flux detector**.
- **Heading Indicator.** This is what most people refer to as 'the compass'.
- **Precession amplifier.** This may also be known as a **slaving amplifier**.
- **Precession motor.** This may also be known as a **slaving** or **synchronising motor**.
- **Horizontal gyro.**

In simple systems, the horizontal gyro is directly connected to the compass card of the heading indicator via a **bevel gear** and a **drive shaft**. This is assumed in the description which follows.

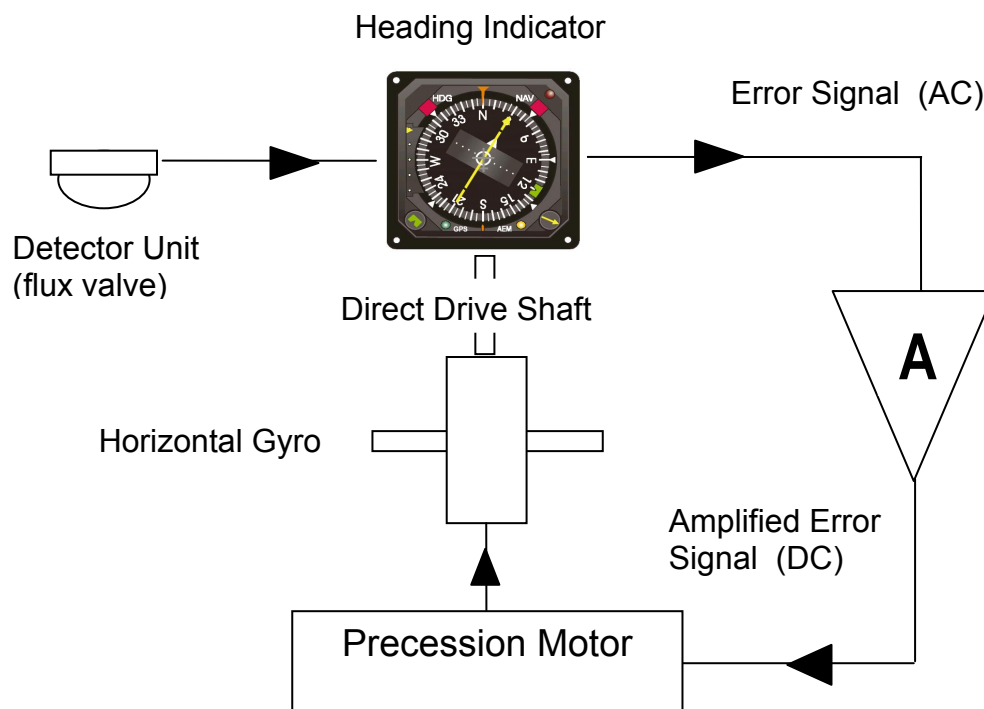

Figure 16.1 Simple Signal Routing

OPERATION WITH STEADY HEADING – CORRECTION FOR GYRO DRIFT

This description assumes a steady heading, which gives a steady input from the Detector Unit (flux valve), and assumes that the compass has already been synchronised. Any difference between the flux valve field and the gyro alignment would only arise if the gyro were to drift.

- The Detector Unit (flux valve) senses the earth's magnetic field and reproduces it within the compass unit, where it is compared with the position of the gyro drive shaft (which also positions the compass card indicator – the indication of heading to the pilot).
- If the two are aligned, no further action takes place. The compass card is reading the right heading. If, however, the gyro starts to drift, the drive shaft will not be in alignment with the flux valve field, and an AC error signal is generated and passed to the precession amplifier (marked with a big **A** in Figure 16.1), where it is amplified, phase detected, and rectified to DC.
- The DC signal drives the precession motor, which turns the gyro. This gyro output is fed via the direct drive shaft to the heading indicator for comparison with the flux valve signal.
- If the two are aligned, the compass is synchronised and no further action takes place. If not, the error correction continues until the compass is synchronised.

It would be possible to cut out the gyro, in theory. The flux valve field could be passed for comparison with the compass card and the error signal passed to a motor which would directly drive the compass card shaft. This would still give an electro-magnetic compass, with a detector unit remote from the major source of deviations, and its output could be used to drive other systems. However, such a system would be overly responsive to any fluctuations in the field detected by the flux valve and would suffer significantly from turning and acceleration errors. **The use of the gyro gives stability and rigidity** because the precession motor applies corrections to the drive shaft at the rate of **approximately only 3° per minute**.

OPERATION IN A TURN – GYRO DRIFT SMALL OVER PERIOD OF TURN

Now consider what happens in a turn. We will assume, initially, that the gyro does not drift during the turn, which is not unreasonable, because even during a full 360° orbit, the turn will only take 2 minutes. The aircraft turns, but the gyro, having rigidity, does not. This gives relative rotation between the horizontal gyro and the instrument case and so operation of the bevel gear causes the direct drive shaft to rotate, changing the heading indication on the compass card. However, at the same time, the heading sensed by the flux valve, which is being passed to the driveshaft for comparison, is changing at the same rate. Therefore no error signal is generated and the compass should remain synchronised during the turn.

If there is some gyro drift during the turn, on completion of the turn there will be a small error signal. This will be taken out as described in the previous paragraph.

RAPID SYNCHRONISATION

When the gyro is started up on initial switch-on, the alignment it adopts is random and is unlikely to be in synchronisation with the earth's magnetic field. Therefore an error signal is detected at the gyro drive shaft. The problem is that the precession motor's normal correction rate is only 3° per minute and if the gyro happened to be 90° out, it would take 30 minutes to synchronise, which is obviously unacceptable.

The solution is to have a rapid synchronisation facility, which can either be a mechanical clutch operated by the pilot (as in the DGI) or, in later compasses, a high gain mode for the precession amplifier (similar in principle to rapid erection in the electric artificial horizon). This is operated by a 2 position switch, spring loaded to the normal position, which has to be held against the spring for rapid alignment. Operation of this switch increases the precession motor's correction rate so that synchronisation takes only a few seconds.

More modern compasses are even more automatic. If a large error is detected **fast precession takes place at, typically, 60°/min** until the error is zero, then the system automatically reverts to the **slow precession rate of, typically, 3°/min**.

We therefore have to modify our original block schematic to include the rapid synchronisation facility:-

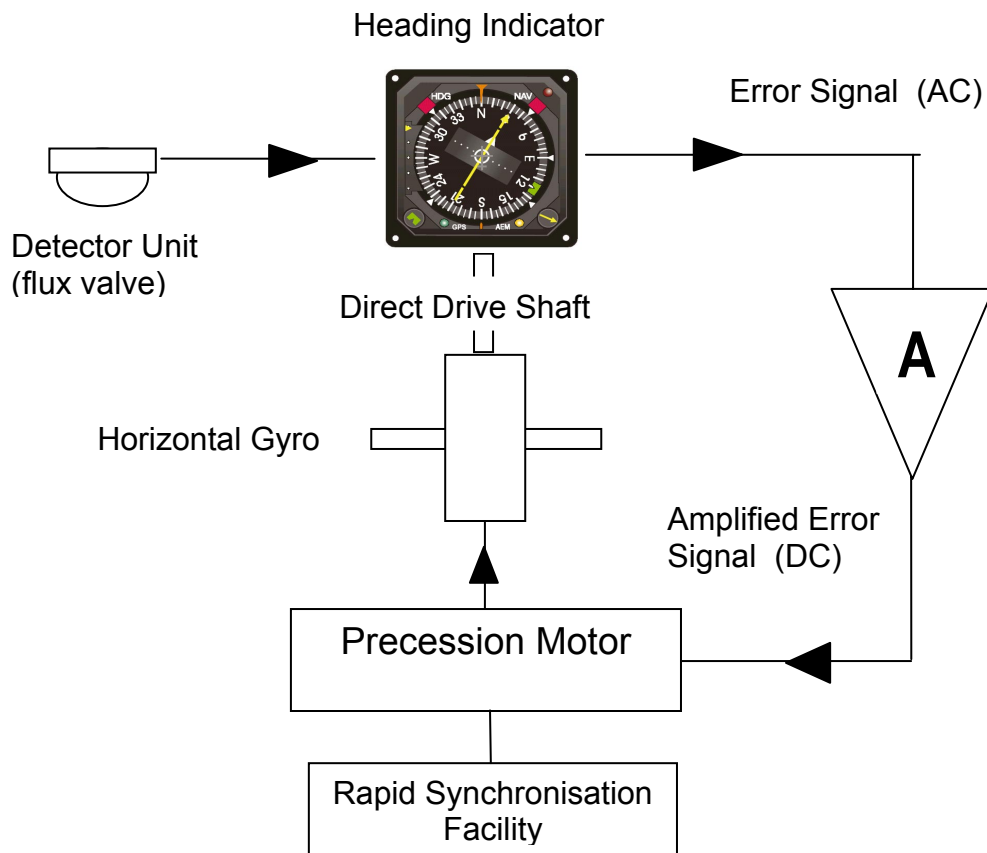

Figure 16.2 Heading Indicator Schematic with Rapid Synchronisation added

DETECTOR UNIT (FLUX VALVE)

The **detector unit is positioned** in a part of the aircraft least affected by on-board electrical fields (usually the wing tip or tail fin, where any aircraft generated magnetic disturbances are at a minimum). Its function is to sense the direction of the earth's magnetic field. It contains a pendulous magnetic detecting element mounted on a **Hooke's Joint** which enables the detector to swing within limits of **25° about the pitch and roll axes**, but allows **no rotation in azimuth**. The unit itself is contained in a sealed case partially filled with oil to dampen any oscillations created during flight.



Figure 16.3 A Magnetic Detector Unit

The circular plate is screwed to the underside of the wing. The black hemisphere protrudes out into the airflow and is simply a protective cover for the flux valve inside. The cable carrying the signals passes along inside the structure of the wing.

The primary component is the **flux valve**, a 3-spoked device, fixed in azimuth but with some freedom in the vertical to allow alignment with the plane of the earth's magnetic field. Parts of the flux valve are shown in Figure 16.4 below.

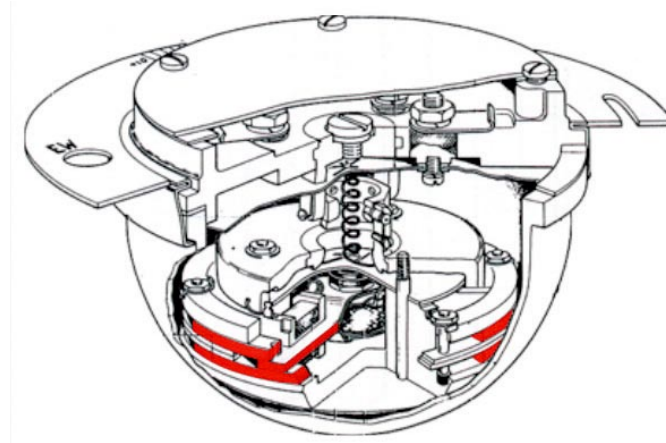

Figure 16.4 Flux Valve components

The parts in red in Figure 16.4 are shown in isolation in Figure 16.5 below. All 3 legs are shown together, as in the actual unit:

The curved 'rams' horns' at the end of each of the 3 legs are simply to improve magnetic flux gathering efficiency, but they do not affect the principle. The flux valve would detect even without them. To explain how the flux valve works, we will start by considering just a single leg (without the 'rams' horns').

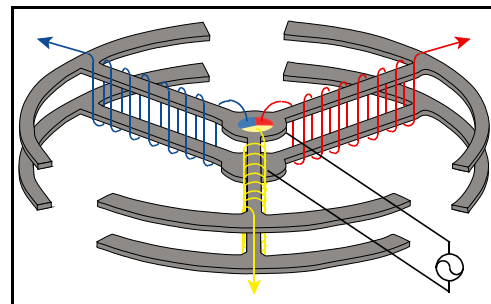

Figure 16.5 Three Flux Valve Legs

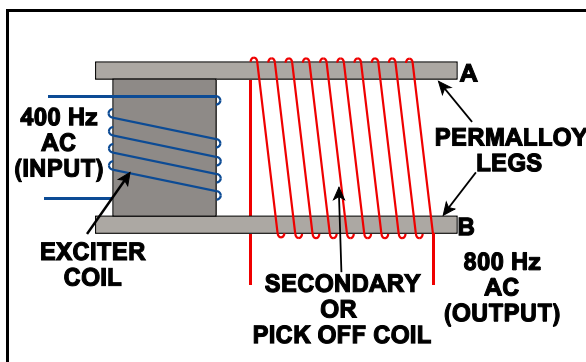

Figure 16.6 A single leg of a Flux Valve

A simplified diagram of a flux valve leg is shown here. Alternating current is fed to the coil wound around the centre post which in turn produces fields of opposite sign in the top and bottom legs of the flux valve.

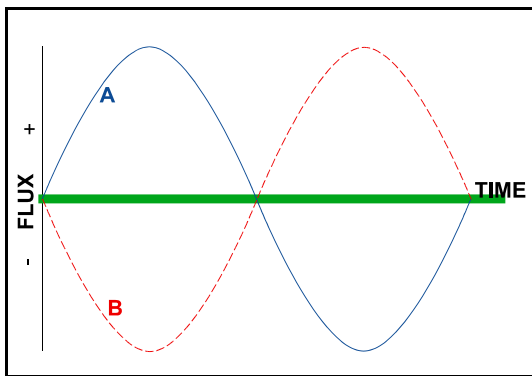

Figure 16.7 Flux fields at A and B and resultant

The magnetic flux (a measure of the density of the lines of force) in legs A and B is shown in Figure 16.7 as red and blue lines. They are at the same frequency and amplitude, but are in anti-phase. If we add the components A and B together, the resultant flux (the green line) is therefore zero, and so no current is induced in the pick-off coil.

If the flux produced by the earth's magnetic field were present as a background, the positive and negative flux would start from a different baseline, which would not be zero. This is shown below in Figure 16.8.

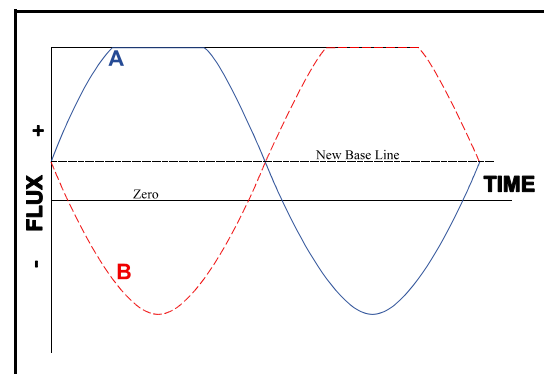

Figure 16.8 Effect of Earth's background magnetism

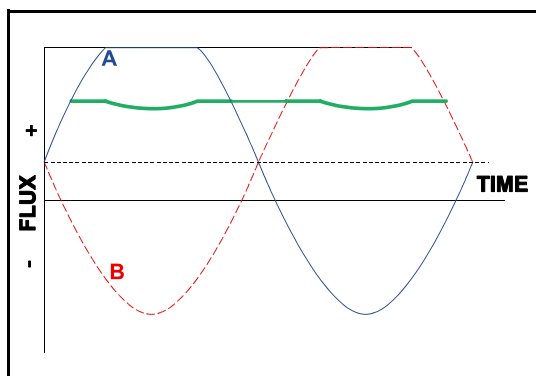

Figure 16.9 Flux density

However, the physical characteristics of the metal used in the flux valve legs are such that they magnetically saturate at a certain level. The metal will not magnetise further beyond a certain point. In this case, the saturation curve tops-out at a limiting saturation level, giving the response shown above (the upper end of the blue and red lines).

When we add the flux level together to see the resultant, the total flux follows the path of the green line.

The operation of the flux valve is in accordance with **Faraday's Law of Electromagnetic Induction**:

'If the number of lines of force threading a circuit is changing, an induced electromotive force will be set up in the circuit, the magnitude of the EMF being proportional to the rate of change in the number of lines of force threading the circuit'

Therefore the **secondary** winding (the one coloured red in Figure 16.5) will pick up **change** in magnetic flux density (the dips in the green line) as an EMF. This will be detected as an AC signal.

Figure 16.10 shows that if the flux valve leg is **in line** with the earth's field, then the EMF induced will be at a **maximum value**. The **secondary winding** (which is aligned with the leg) is shown in the diagram. If the flux valve leg is at **right angles** to the field, then the EMF induced will be **zero**.

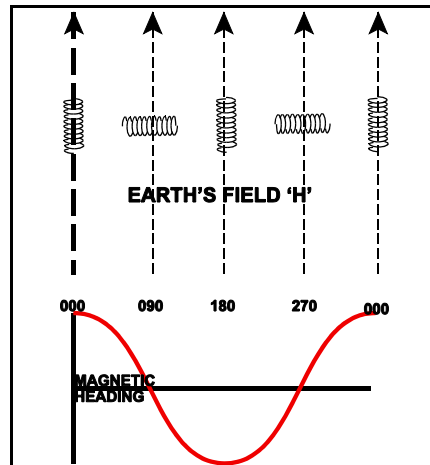

Figure 16.10 Effect of Earth's field on different directions of flux valve leg

Figure 16.10 shows that the EMF induced varies as the cosine of the magnetic direction of the flux valve leg. Unfortunately, this cannot be transformed directly into heading because, except for 0° and 180° , there are 2 possible values of heading for each value of voltage. Furthermore, any slight change of input voltage would give an altered value of output voltage, resulting in a different measured heading.

Instead, the 3-leg system shown in Figure 16.5 is used and the output from each leg is fed to one of the 3 legs of a stator. This re-creates the earth's field relative to the direction of the flux valve as shown in Figure 16.11, around the direct drive shaft from the gyro to the heading indicator compass card.

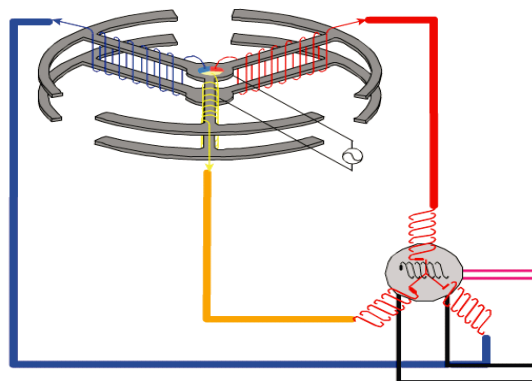

Figure 16.11 Connection of flux valve to stator legs

ERROR SIGNAL COMPARISON

Earlier we said that if there were any difference between the gyro shaft alignment and the magnetic field detected by the flux valve, an error signal would be generated which would be amplified to precess the gyro so that it takes up the alignment of the magnetic heading. This error signal detection is achieved by rotor-stator comparison.

A wound coil is mounted on the gyro drive shaft. This coil is known as a rotor. If the coil is in line with the AC field generated by the stators, a secondary AC voltage will be induced in the rotor (similar to the situation shown in Figure 16.10). If the rotor is at 90° to the AC field, no secondary voltage is induced. This is known as the **null position**. At any position other than the null, some secondary voltage is induced. This secondary induced voltage is passed to the **precession amplifier** where it is amplified, phase detected, and rectified to DC.

Amplified. The reason for the amplification is that the un-amplified error signal is not powerful enough to drive the precession motor.

Phase Detected. It is important that the precession motor 'knows which way to turn'. Suppose that the gyro shaft is misaligned 2° clockwise from the null. The motor should rotate the shaft 2° anti-clockwise, not all the way round 358° clockwise. Otherwise, the system would go into continuous rotation. The purpose of phase detection is to detect the sense of the error.

Rectified. The mechanism of the precession motor is an electromagnetic solenoid acting on a permanent magnet. This requires DC. The amplified AC is therefore rectified to DC which, depending on the phase detected, will either be in a positive or a negative direction, turning the shaft either clockwise or anti-clockwise for the shortest route for error correction.

HEADING INDICATOR

The Heading Indicator dial (compass card) is directly driven by the shaft from the gyro. The compass card rotates as heading changes and the heading is read against the index line in the 12 o'clock position (the **lubber line**).

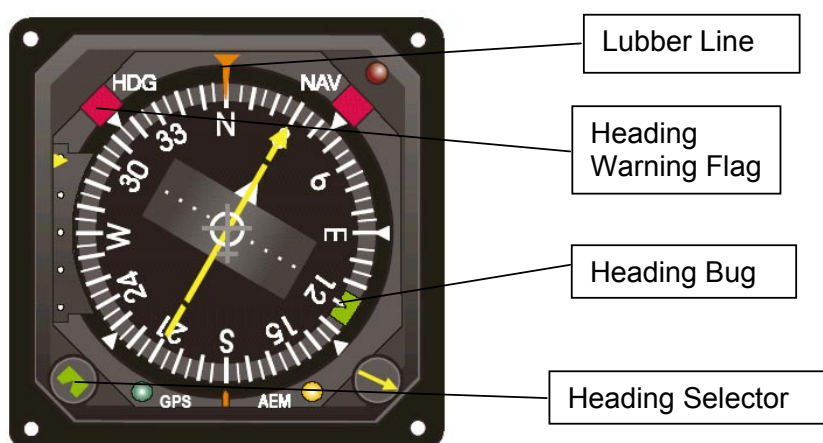

Figure 16.12 Typical Heading Indicator

A **desired heading** can be selected by the pilot by rotating the **heading selector control**. The **heading select marker** (usually called a 'bug') indicates the selected heading. If the **magnetic input from the flux valve fails**, a warning is given in the form of a **heading warning flag**.

OPERATION AS A DGI

If the magnetic input from the flux valve should fail or if it becomes unreliable due to proximity to one of the Earth’s magnetic poles, it is possible to operate the gyro-magnetic compass in gyro mode only, in which case it acts as a DGI and will need to be re-set periodically to a directional reference such as a standby compass or other source of aircraft heading. When it operates as a DGI, this is referred to as **FREE** mode, whilst its normal magnetically monitored operation is referred to as **SLAVED** mode.

Figure 16.13 shows a typical modern compass controller. With the **FREE/SLAVE** switch at **SLAVE**, the compass operates as previously described, with the gyro slaved (in the long term) to the input from the flux valve. If the switch is moved to **FREE** the magnetic signal from the flux valve is disconnected, the rotor/stator comparison ceases, and the gyro is no longer tied in azimuth and so acts as a free gyro (DGI).

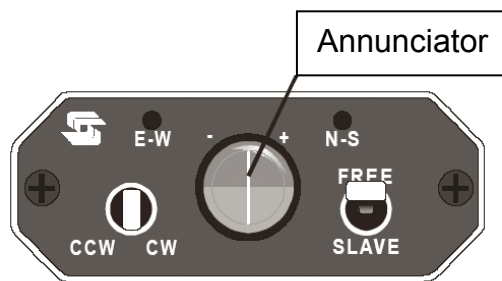

When the Heading Indicator in **FREE** the pilot adjusts the indicated heading in order to correct it to an external datum heading by use of the CCW/CW (counter-clockwise/clockwise) control switch, which is spring-loaded to the central position.

Figure 16.13 Compass Control Panel

ANNUNCIATOR

During normal flight in **SLAVE** mode there is usually continuous slight motion due to oscillations of heading and to vibration which means that rotor/stator comparison of the magnetic flux valve signal against the gyro shaft position continuously generates very small error signals. The error signal and therefore the precession amplifier are continuously ‘hunting’. This is normal, and is how the system is designed to work.

These error signals pass through an indicator on their way from the amplifier to the precession motor. This indicator is called an **annunciator** and an example is shown in Figure 16.13.

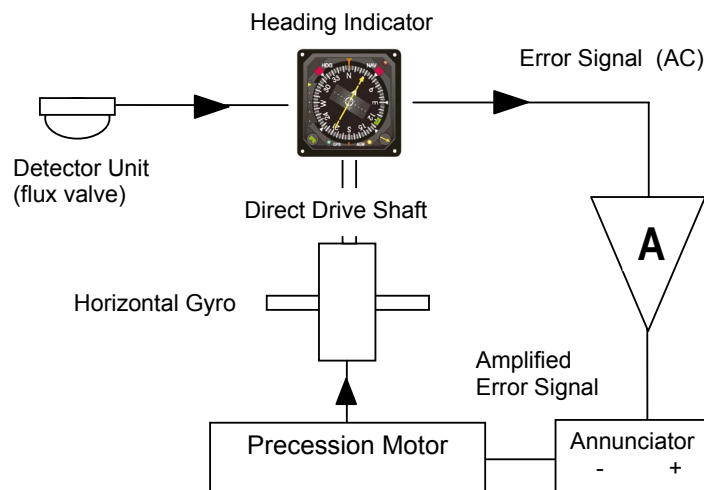

Figure 16.14 Annunciator in Circuit

The annunciator is useful to the pilot for 2 main reasons:

- It is an indication that magnetic monitoring of the gyro is taking place. It shows that **the compass is 'synchronised'**.
- On systems where it is necessary for the pilot to synchronise manually, it indicates **which way to turn** the compass.

KEEPING THE GYRO AXIS HORIZONTAL

Gyro wander can take 2 forms - drift and topple. The tendency to drift is overcome, as already described, by slaving the gyro to the flux valve output, thereby making it a tied gyro in azimuth.

However, the gyro would still topple, over a period of time, unless prevented from doing so. It therefore needs to be tied, either to the aircraft yaw axis, or to gravity in order to keep it erect. Both the yaw axis and the vertical as defined by gravity have been used as the datum in various models of compass. Both systems use a **levelling switch** and a **torque motor**.

To tie the gyro to the yaw axis, the inner and outer gimbals are maintained at 90° to each other by a system of commutators, insulating strips and brushes. To tie the gyro to the vertical, mercury gravity switches are used. Either way, the correcting signals are passed to a torque motor which applies a rotational force to the gyro in the yaw axis. The resulting precession causes the gyro to return to the horizontal, but at a slow precession rate, so that it does not react wildly to temporary departures from the horizontal such as turns, accelerations, climbs and descents.

TRANSMITTING HEADING OUTPUT TO OTHER INSTRUMENTS

One of the advantages of the gyro-magnetic compass over the simple direct reading compass is the facility to electrically transmit heading information to use as an input into other instruments. The information is picked off from the drive shaft between the gyro and the compass card. The transmitting and receiving device is called a Selsyn Unit.

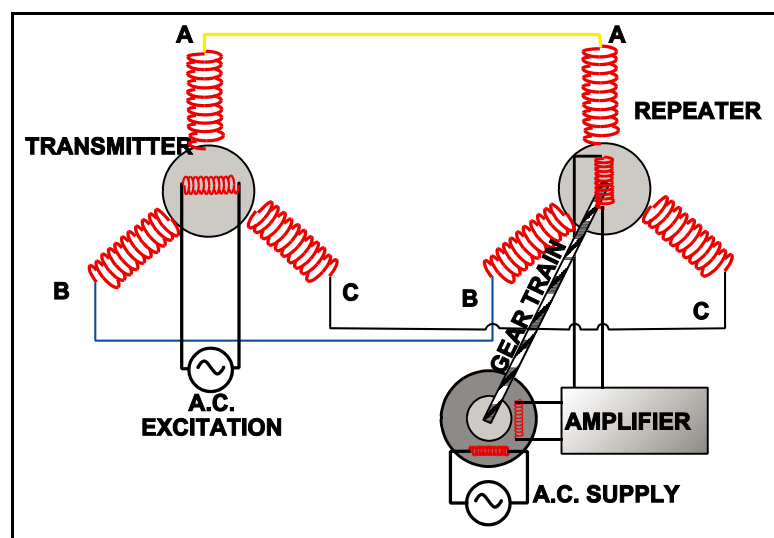

Figure 16.15 Selsyn Unit

The rotor of the transmitter (shown in Figure 16.15) is attached to the heading drive shaft and rotates with it. The orientation of the rotor is therefore the heading which is to be transmitted. The rotor is supplied with a constant primary excitation AC voltage, which induces a field in the stators. The stators are directly connected by 3-strand wire to the 3 stator arms of the repeater, so an identical field is reproduced there.

If the rotor of the repeater is not perpendicular to the field in the repeater stators, an AC voltage will be induced in this repeater rotor. This is passed to an amplifier and then to a motor to turn a shaft on which the repeater rotor is mounted. The repeater shaft will turn until no further voltage is detected. The repeater shaft therefore follows any heading changes in the main gyro drive shaft.

OTHER FACILITIES (NOT FOUND IN ALL GM COMPASSES)

There are some facilities and functions which may be found in some gyro-magnetic compasses but not in others, depending on the complexity and the vintage of the particular model.

Correction for Variation. A compass measures magnetic heading, but an earlier generation of automatic navigation equipment needed to operate with an input of True heading. Many compasses have been designed with a facility to correct for variation. The principle is simple. The crew member turns a knob with a graduated dial on it to the desired value of variation E or W. This turns a shaft which offsets the angle at which the stators receiving the flux valve field are set, by the amount of variation. Thus, the new null position for the rotor will be the magnetic field plus the variation and so the gyro will take up True, not magnetic, heading. All indications in the aircraft are True, which is more satisfactory for the navigation equipment but, since ATC invariably work in magnetic headings, the crew have to remember to correct back to magnetic for ATC instructions and other communications. Later magnetic compasses had a TRUE/MAG switch, which allowed the pilot to have magnetic heading displayed, if required, whilst True was passed to the navigation equipment. It was still necessary, for both types, for the crew to remember to keep the variation updated as the isogonals changed along their route.

This facility has become less popular recently because the modern generation of area nav equipment tend to be digital computers (often of little more complexity than a scientific calculator) and it is a simple matter to leave the compass in magnetic for ATC purposes and have automatic arithmetical addition of variation in the present position computer.

Acceleration and Bank Cut-out Switches. Turning and acceleration errors are greatly reduced in the slaved gyro compass, compared with the direct reading compass because of the rigidity of the gyro. Nevertheless, because the Hooke's joint is pendulous the detector unit will swing back from the vertical in accelerations and swing out from a turn because of centrifugal force. However, because of the slow slaving rate these turning and acceleration errors affect the gyro very little, and only for a short length of time, and the error is slowly corrected out again by slaving once straight and level unaccelerated flight is regained.

These errors, small though they are, can be reduced by **disconnecting the slaving whilst turns and accelerations take place**. Some GM compasses have longitudinal accelerometers and bank cut-out switches, much like the electric artificial horizon. An **acceleration of 0.18g or a bank angle of 10° or more** causes the signal from the flux valve to be disconnected and the system operates as a DGI during the turn. Once the bank or acceleration is over, slaving takes place again and, if any error was introduced during the turn through gyro drift, it should be less than that which would have been introduced by the (very small) turning and acceleration errors, and is soon slaved out again.

Two –Indicator One-Gyro Systems. Some compass systems use 2 heading indicators (for a 2-pilot aircraft) but only one gyro. The second heading indicator is aligned to the gyro by a follow-up amplifier. The diagram is below, in Figure 16.16.

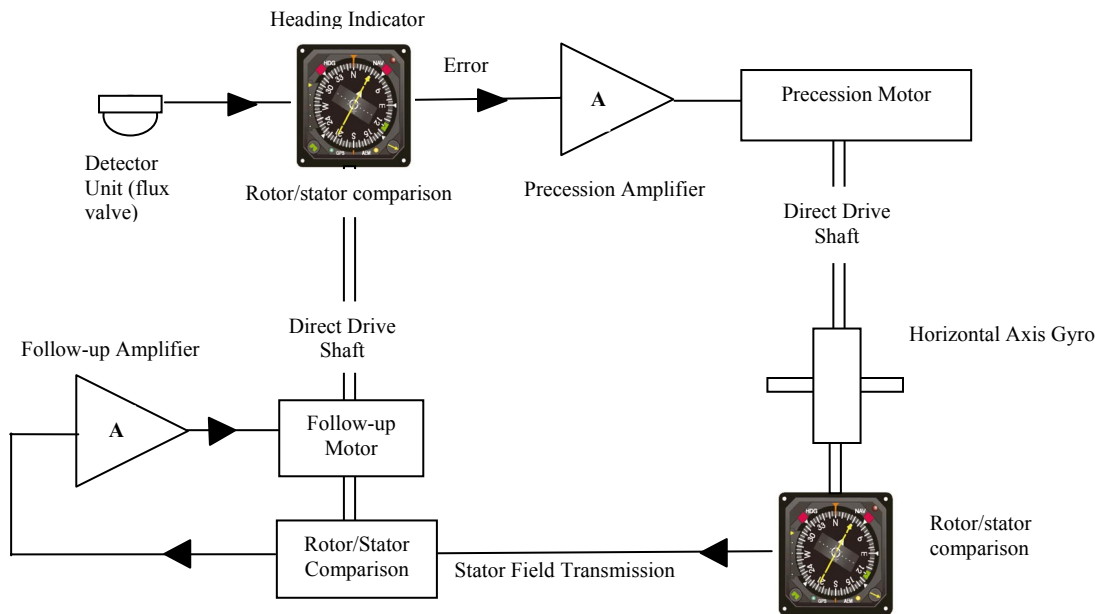

Figure 16.16 Two Heading Indicators Driven by One Gyro

The Earth's magnetic field is detected at the flux valve and reproduced in the stators in the first Heading Indicator. If the rotor on the direct drive shaft from the follow-up motor is not in the null position an error signal is detected and passed to the precession amplifier and precession motor in order to precess the gyro. This will rotate the shaft on the second Heading Indicator, re-positioning a rotor on this shaft. This induces a field in the stators which is reproduced in another set of stators on the first heading indicator. Rotor/stator comparison takes place and any error is passed to the follow-up amplifier and motor, which re-positions the direct drive shaft, thereby moving it to the null position and removing the original difference between the follow-up shaft and the flux valve.

The precession to the gyro is at a slow rate – typically, 3° a minute - since, except for initial synchronisation, the gyro should be in the correct orientation and only needs to be prevented from drifting. Therefore the precession amplifier and precession motor have a **slow** correction rate.

However, there is no gyro on the follow-up shaft. This shaft is turned by the follow-up motor and has to follow the turn rates of the aircraft, which may be 500 to 600° a minute. The follow-up amplifier and follow-up motor are therefore designed to have a **fast** follow-up rate.

Remote Systems. Some systems have very high-grade gyros indeed. These could be found in a high-quality twin gyro platform, or the platform of an inertial navigation system. In this case, the gyros drift rate may be as low as between $0.1^\circ/\text{hour}$ and $0.01^\circ/\text{hour}$ and any attempt to precess the gyro using magnetic monitoring would actually degrade it. Nevertheless, there is still value in comparing it with a flux valve in order to pick up any gyro failure or rapid degradation. In this case, a system of comparing the magnetic and gyro outputs which does not disturb the gyro by precessing it is used.

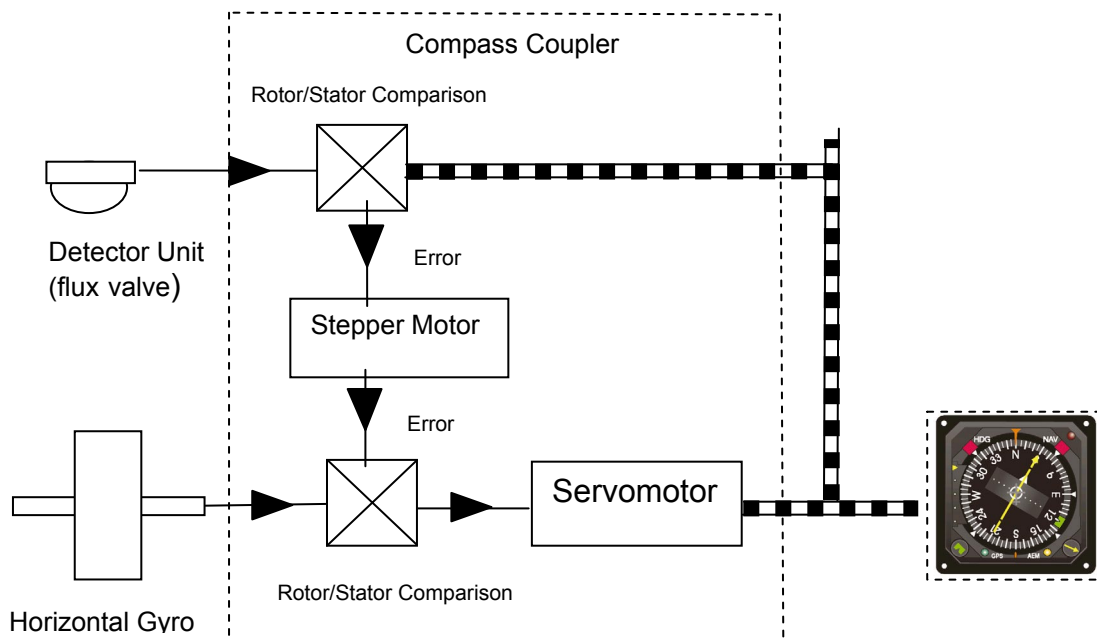

Figure 16.17 Remote System with Compass Coupler

Instead of precessing the gyro the output of the gyro is fed to a comparison system called a **compass coupler**. To see how the comparison takes place, start by assuming that the compass is synchronised and that the main shaft output to the heading indicator is the same as the input from the gyro. The output from the main shaft is compared with the output from the flux valve. If there is any difference, an error signal is fed to a **stepper motor**. This is a device with a **slow follow-up rate** (in order to avoid reacting rapidly to minor routine fluctuations from the flux valve). This error signal is now added to the output of the horizontal gyro and the combined signal is passed to the servomotor to slowly adjust the main shaft to correspond to the flux valve output. This results in a system which maintains magnetic monitoring in the long-term, but only allows the stable output of the gyro to be corrected slowly.

If the gyro were to drift (which should not happen to any significant degree) the servomotor will turn the shaft. There will now be an error between the flux valve and the shaft which will be passed through the stepper motor slowly and will be added to the output from the gyro, and the combined signal will be passed to the servomotor, repositioning the shaft to the long-term flux valve magnetic output. The gyro output is adjusted and corrected to the magnetic source whilst still maintaining the advantage of gyro stability and without precessing the gyro.

Dual Systems. Dual systems are simply 2 gyro-magnetic compasses together. They can operate either independently (**NORMAL** switch position) or, in the event of a failure in one system, both heading indicators can be fed from the other gyro-magnetic compass (**BOTH ON 1** or **BOTH ON 2**).

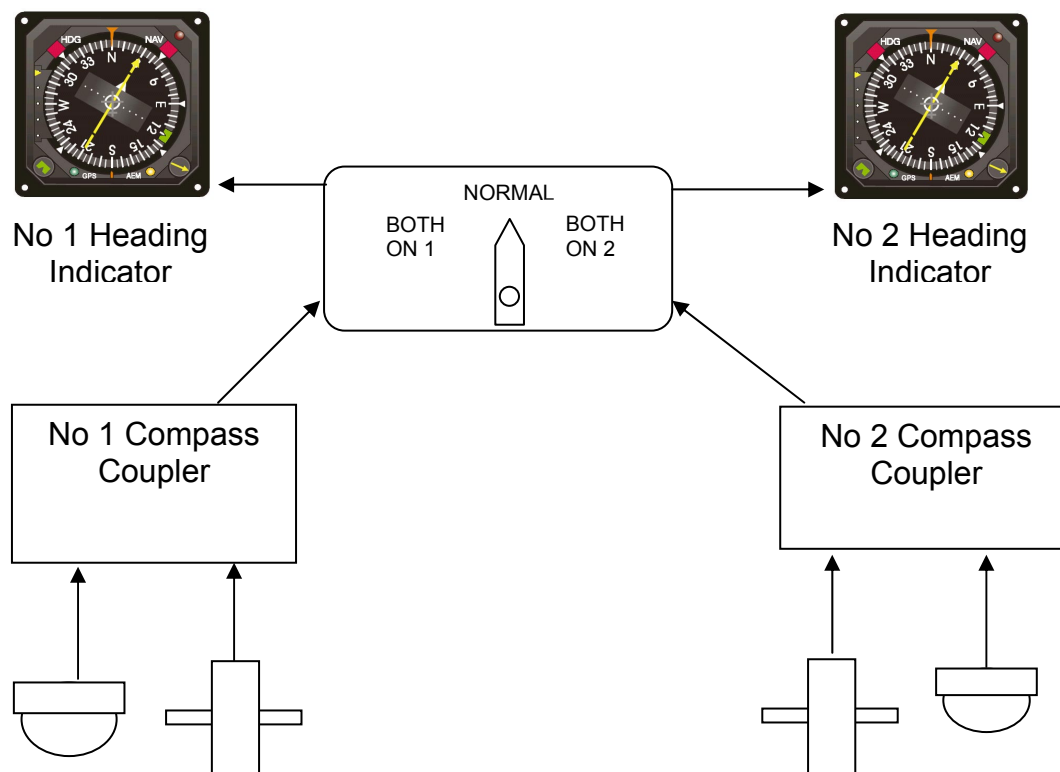

Figure 16.18 Typical Dual System

SUMMARY

The gyro magnetic compass system overcomes the weaknesses of the direct reading compass (turning and acceleration errors, magnetic element close to source of deviations, no feed to other equipments) and of the directional gyro (no magnetic monitoring).

The gyro magnetic compass system combines the short term stability of a gyroscope with the long term directional stability of the earth's magnetism.

QUESTIONS

- 1 A gyro-magnetic compass or magnetic heading reference unit is an assembly which always consists of :
- 1- a directional gyro
 - 2- a vertical axis gyro
 - 3- an earth's magnetic field detector
 - 4- an azimuth control
 - 5- a synchronising control
- The combination of correct statements is :
- a 2 and 5
 - b 1, 3 and 5
 - c 2, 3 and 5
 - d 1 and 4
- 2 A slaved directional gyro derives its directional signal from:
- a a direct reading magnetic compass
 - b the flight director
 - c the flux valve
 - d the air data computer
- 3 The gyro-magnetic compass torque motor:
- a causes the directional gyro unit to precess
 - b causes the heading indicator to precess
 - c feeds the error detector system
 - d is fed by the flux valve
- 4 The heading information originating from the gyro-magnetic compass flux valve is sent to:
- a error detector
 - b erector system
 - c heading indicator
 - d amplifier
- 5 The input signal of the amplifier of the gyro-magnetic compass resetting device originates from the:
- a directional gyro erection device
 - b error detector
 - c flux valve
 - d directional gyro unit
- 6 Heading information from the gyro-magnetic compass flux gate is transmitted to the:
- a amplifier
 - b error detector
 - c erecting system
 - d heading indicator

7 A flux valve senses the changes in orientation of the horizontal component of the earth's magnetic field :

- 1- the flux valve is made of a pair of soft iron bars
- 2- the primary coils are fed AC voltage
- 3- the information can be used by a "flux gate" compass or a directional gyro
- 4- the flux gate valve casing is dependent on the aircraft three inertial axis
- 5- the accuracy of the value of the magnetic field indication is less than 0.5%

The combination of correct statements is :

- a 2, 3 and 5
- b 1, 3, 4 and 5
- c 3 and 5
- d 1, 4 and 5

ANSWERS

- 1 B
- 2 C
- 3 A
- 4 a
- 5 B
- 6 b
- 7 A

CHAPTER SEVENTEEN
INERTIAL NAVIGATION SYSTEM

Contents

INTRODUCTION225

BASIC PRINCIPLES OF INS226

ACCELEROMETER AND INTEGRATORS226

ACCELEROMETERS227

GRAVITY EFFECTS ON ACCELEROMETER.230

THE INTEGRATING GYROSCOPE231

THE PLATFORM.232

EARTH ORIENTATION.233

APPARENT WANDER233

ALIGNMENT OF THE SYSTEM234

SCHULER PERIOD235

ERRORS OF INS236

BOUNDED ERRORS.236

UNBOUNDED ERRORS236

INHERENT ERRORS237

INS CONTROL AND DISPLAY PANELS237

SUMMARY INS WARNING LIGHTS240

LED DISPLAY240

MANUAL AND AUTOMATIC SYSTEM CHECKS244

QUESTIONS245

ANSWERS248

INTRODUCTION

The fundamental element of this complex system is the Inertial Sensor System (ISS). To make up this system we have a stable platform consisting of high quality gyros and accelerometers and a computer.

The purpose of the computer is to integrate the accelerometer outputs with time to give velocity and then integrate velocity with time to give distance travelled. From this is available pitch and roll attitude, true heading, true track, drift, present position in latitude and longitude, groundspeed and wind. To change all this information from ISS to Inertial Navigation System (INS) we have a further computer which allows us to inject and store waypoints and then compute track angle error, distance and time to go to reach them. This information can be used by the autopilot, flight director or for normal manual flying of the aircraft.

The modern INS was the first self contained single-source of all navigation data; now joined by the similar IRS, Laser Gyro System which will be discussed later. The current state-of-the-art engineering has enabled production of INS with performance, size and weight characteristics which far exceed other older navigation systems.

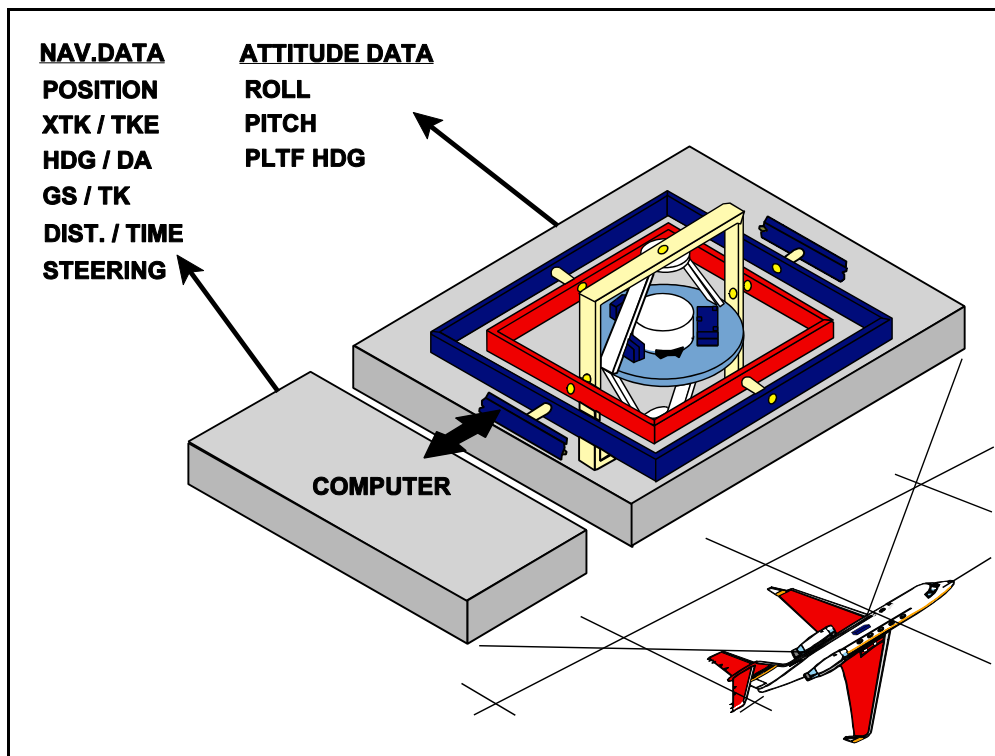

Figure 17.1 Basic Principles of INS

BASIC PRINCIPLES OF INS

Newton's laws of motion state:

- A body continues in a state of rest, or uniform motion in a straight line, unless it is acted upon by an external force.
- The acceleration - rate of change of velocity - of a body is directly proportional to the force acting on the body and is inversely proportional to the mass of the body.
- To every action there is an equal and opposite reaction.

Einstein however, in 1905, totally destroyed the premise of absolute motion. The substance of his new theory was that nothing is at rest and that the term at rest meant merely that the object under observation was moving at the same velocity as some other object, its co-ordinate system and the observer.

The primary measuring device in an INS, the accelerometer, demonstrates this theory for it makes no distinction between at rest and any other fixed velocity. It does however, make distinction between truly fixed velocities and those which we may regard as fixed, but are really fixed speeds along curved paths.

ACCELEROMETER AND INTEGRATORS

Two accelerometers are mounted at the heart of the inertial system. These acceleration measuring devices sense any change in the aircraft's velocity either as an acceleration or deceleration very accurately.

One of the accelerometers ensures the aircraft's acceleration in the North-South direction and the second in the East-West direction.

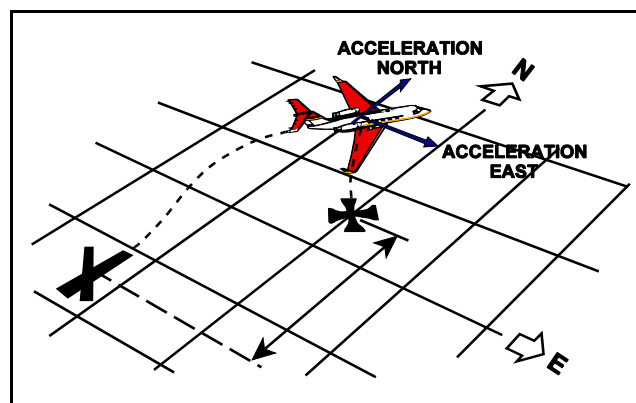

Figure 17.2 Accelerometer and Integrators

The accelerometer is basically a pendulous device. When the aircraft accelerates, the pendulum, due to inertia, swings off the null position. A signal pick off device tells how far the pendulum is off the null position. The signal from this pick off device is sent to an amplifier and current from the amplifier is sent back into a torque motor located in the accelerometer. A torque is generated which will restore the pendulum to the null position. The amount of current that is going into the torquer is a function of the acceleration which the device is experiencing.

The accelerometers would be mounted on a platform, there would be two, one in the North-South direction, the other in the East-West direction (often a third accelerometer is fitted to measure vertical acceleration).

ACCELEROMETERS

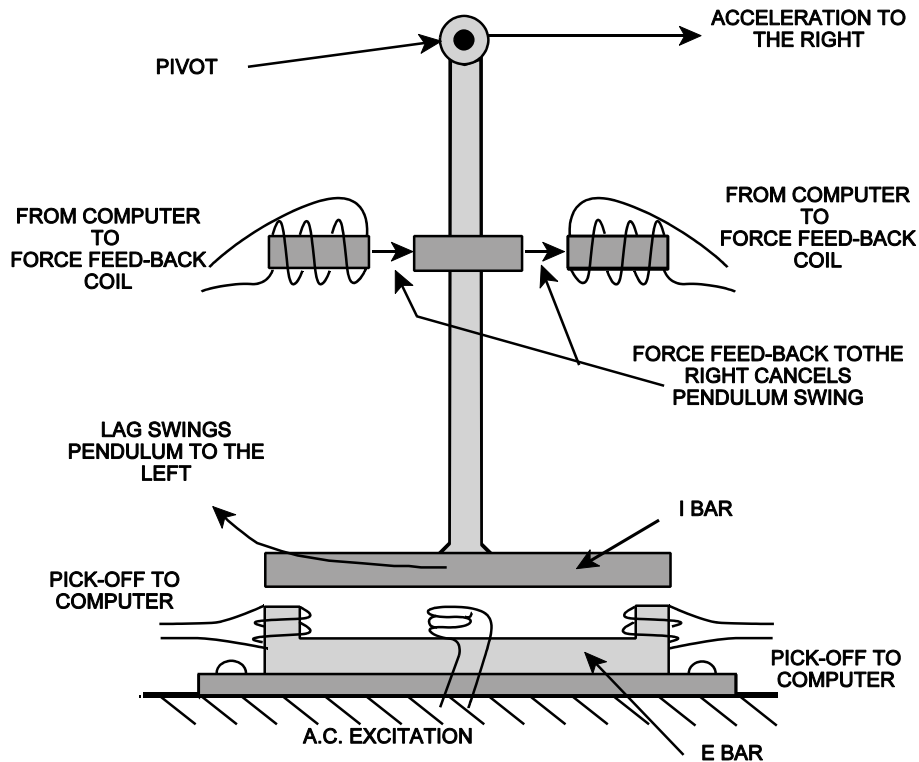

Figure 17.3 Accelerometer

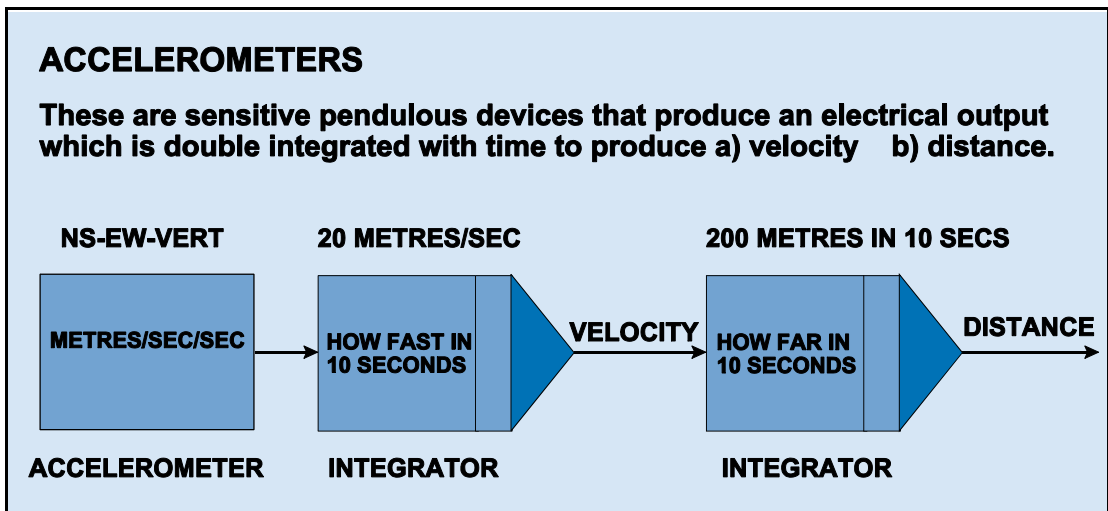

Figure 17.4 Accelerometers

The acceleration signal from the amplifier is also sent to an integrator which is a time multiplication device. It starts out with acceleration which is in feet per second squared. In the integrator, it is literally multiplied by time and the result is a velocity in feet per second.

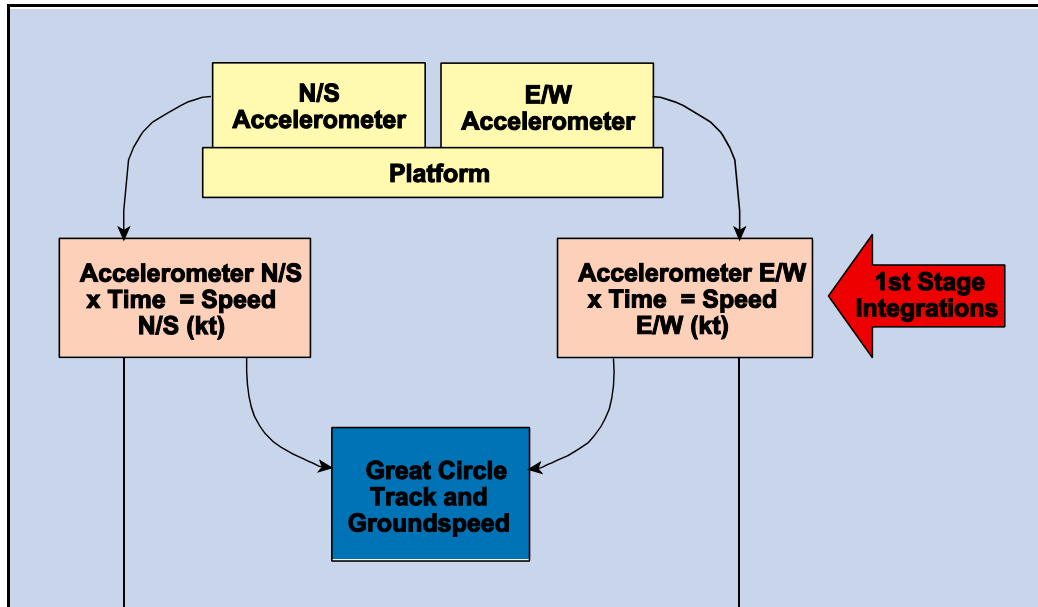

Figure 17.5 Accelerometers and Integrators

It is then sent through a second integrator, and again, it's just a time multiplier. With an input of feet per second which is multiplied by time, the result is a distance in feet or nautical miles.

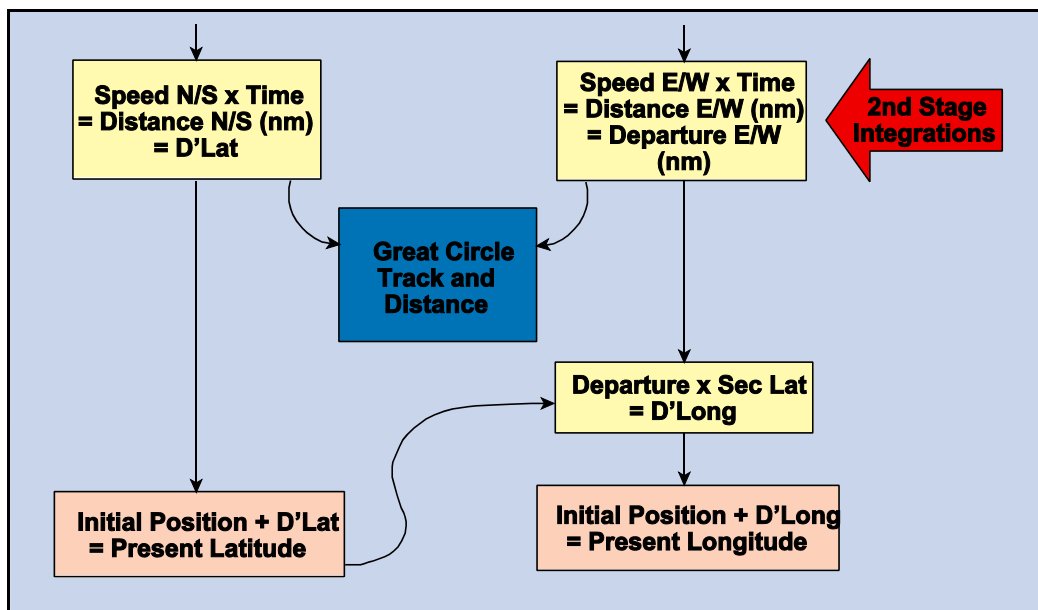

Figure 17.6 Accelerometers and Integrators

The accelerometers would be mounted on a platform, there would be two, one in the North-South direction, the other in the East-West direction (often a third accelerometer is fitted to measure vertical acceleration).

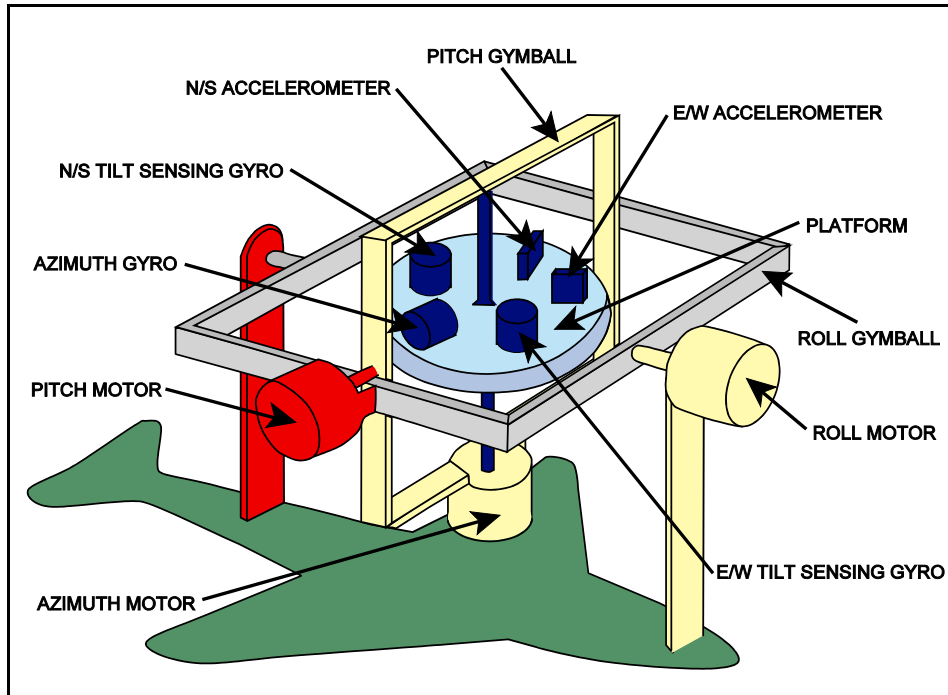

Figure 17.7

The computer associated with the inertial system knows the latitude and longitude of the take-off point and calculates that the aircraft has travelled so far in the North direction and so far in an East direction. The computer can then compute the new position of the aircraft and give a digital read out which we should note is to tenths of a degree.

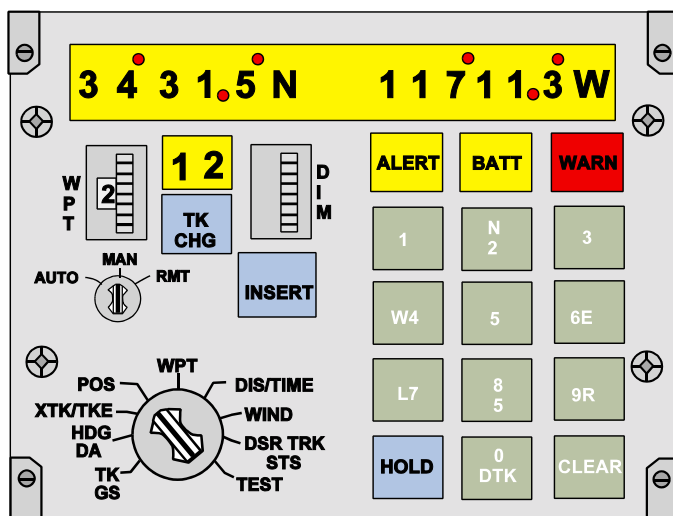

Figure 17.8 POS (Present Position)

In like manner using stored velocity, and present positions the system is able to calculate additional navigation data and display it as requested by the operator. The information is chosen for display through the rotary switch at the bottom left of the control unit: the information that may be obtained will be described in full later.

GRAVITY EFFECTS ON ACCELEROMETER

Normally the accelerometer is part of the gyro stabilised platform, but if it was hard mounted to the aircraft it could suffer problems in the pitch and roll planes.

The fact that the device has been tilted makes the pendulum swing away from the null position through the effects of gravity.

If this were to take place it would obviously output an erroneous acceleration signal which would in turn result in an erroneous velocity and distance travelled. Therefore, if we allow this there will be a false acceleration problem caused by the pitch or roll angle. If the accelerometer was kept earth horizontal this would not happen and no error would occur.

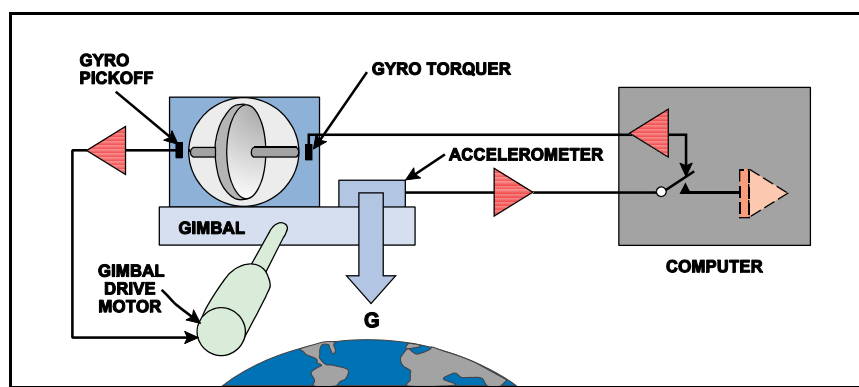

Figure 17.9 Gravity Effects on Accelerometer

THE INTEGRATING GYROSCOPE

An integrating gyroscope used in INS's is a one degree of freedom gyro using viscous rather than mechanical (spring) restraint as seen in the more commonly found rate gyroscope

Figure 17.10 shows a simple rate- integrating gyro. It is basically a can within which another can (the inner gimbal) is pivoted about its vertical axis. The outer can (frame) is filled with a viscous fluid which supports the weight of the inner gimbal so reducing bearing torques.

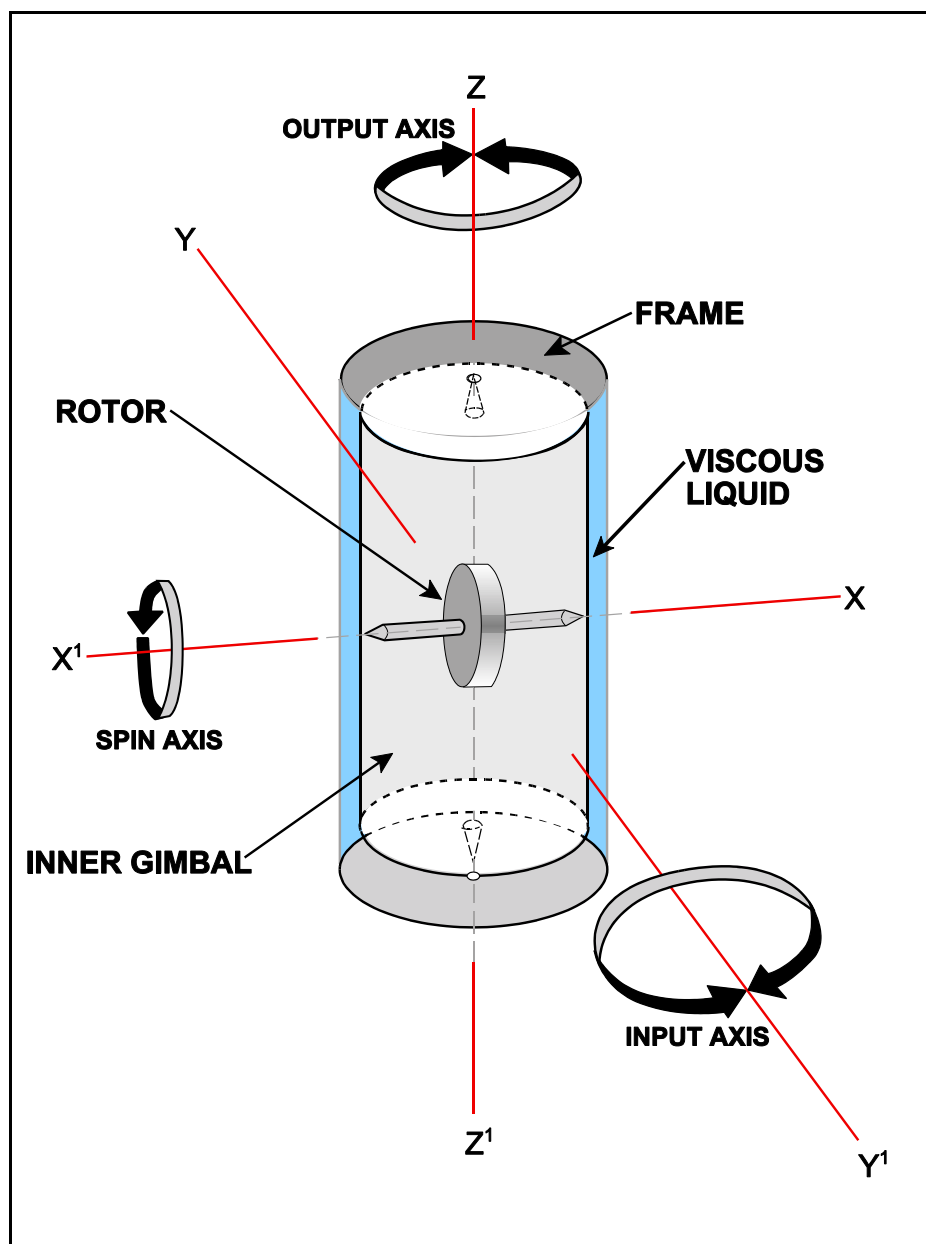

Figure 17.10 Rate-Integrating Gyroscope

THE PLATFORM

To keep the accelerometer level, it is mounted on a gimbal assembly, commonly called the platform. The platform is nothing more than a mechanical device which allows the aircraft to go through any attitude change and yet the very inner element of the platform on which the accelerometers are mounted is able to stay earth level. Gyroscopes which are used to stabilise the platform are also mounted on the inner-most element of the platform. They provide inputs to amplifiers and motors which control the gimbals and keep the accelerometers level.

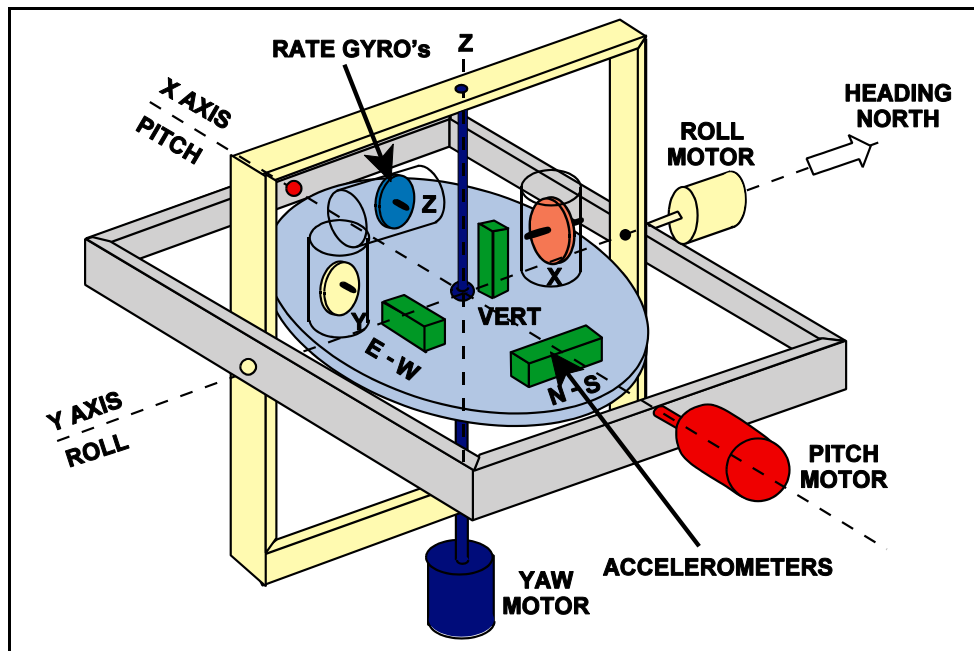

Figure 17.11 The Platform

The gyro and the accelerometer are mounted on a common gimbal. When this gimbal tips off the level position, the spin axis of the gyro will remain fixed. The case of the gyro, then, is moved off level and the amount that the case is tipped will be detected by the signal pick off in the gyro. That signal is then amplified and sent to a gimbal drive motor which restores the gimbal to the level position again. Since the accelerometer is always kept level, it does not sense a component of gravity and is able to sense only the horizontal accelerations of the aircraft as it travels across the surface of the earth.

In reality, three integrating gyros are mounted on the inertial platform, with their input axis mutually perpendicular. Three gimbal motors drive the platform gimbal rings about the pitch, roll and vertical axes respectively. The gyros sense incipient displacement of the platform and activate the appropriate motors to provide for the relative movement of the gimbal rings, as the aircraft moves about the stable platform.

EARTH ORIENTATION

The previously described gyro stabilised platform would remain fixed in space, but the aircraft is not operating in space. It is operating on an earth which is rotating and an earth which is assumed to be round. In order to keep the accelerometers level with respect to the earth so that they sense acceleration of the aircraft in a horizontal direction only, some compensation must be made for the earth rotating and the earth being assumed to be round.

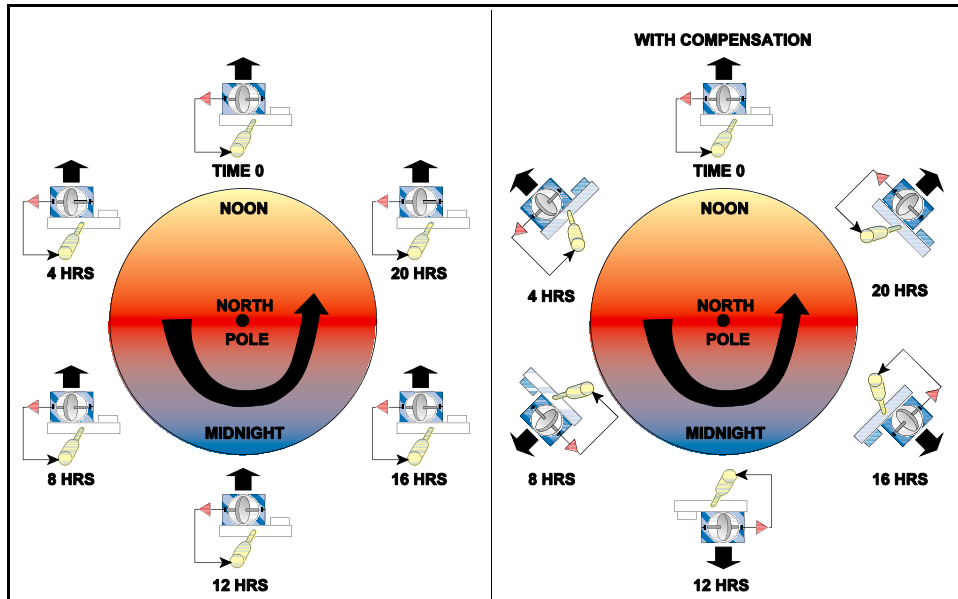

Figure 17.12 Earth Orientation

APPARENT WANDER

Corrections must be made to gyroscopically stabilised platforms to allow for apparent wander due to earth rotation and aircraft movement over the earth. The required earth rate compensation is a function of latitude since what is being compensated for is the horizontal component of the earth rate felt by the gyros, and that varies with latitude. At the equator, this value is Zero degs per hour and with travel either further North or South, it increases until it becomes a maximum of +/- 15.04 at the poles.

Transport rate compensation is developed using the velocity signal. The electronics through which it is sent contain a term proportional to the earth's radius. So, in reality, the transport rate signal torquing the gyro is the velocity of the aircraft divided by the earth's radius.

Both the earth rate and transport rate compensations are compensated by torquing the gyro. The following diagram should be used to follow the system as explained

There are a number of compensations generated within the system..

Coriolis and Centrifugal effects must be compensated for within the system. Other compensations are necessary because the earth is not a perfect sphere

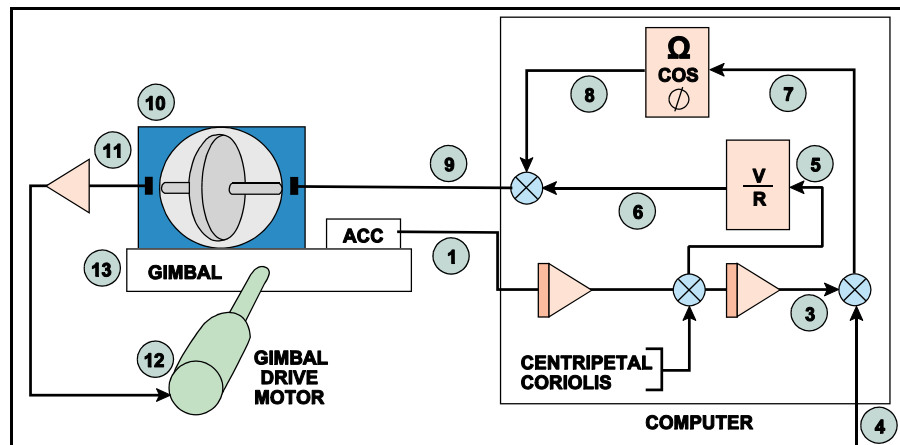

Figure 17.13

- Centrifugal accelerations caused by platform rotation to maintain the local earth vertical.
- Coriolis accelerations caused by the aircraft following a curved path in space when flying normal earth referenced flights.

ALIGNMENT OF THE SYSTEM

● ACCELEROMETERS MUST BE LEVELED (VELOCITY SET TO ZERO)

Initial levelling. If the platform is not Earth horizontal one or both of the accelerometers will sense an output which is due solely to gravity (since the aircraft is stationary). These tilt-induced outputs from the accelerometers are used to drive the appropriate torque motors (pitch and / or roll) to level the platform.

● PLATFORM MUST BE ORIENTED TO TRUE NORTH (GYROCOMPASSING) (POSITION VERIFIED)

Initial alignment (Gyro-Compassing). Once the platform is levelled, the alignment process is automatically commenced, using a technique which is known as Gyro-Compassing. The platform is now earth horizontal, but will not remain so because of the earth's own rotation about its spin axis.

Figure 17.14 Accelerometers and Integrators

The stable element in an INS must be accurately aligned in both azimuth and attitude to allow the accelerometers to measure accelerations along their chosen axes.

- **Warm up** period - the first stage in any alignment sequence is to bring the fluid-filled components to the correct operating temperature. This phase normally takes between 3 to 4 minutes.
- **Coarse alignment** - the platform is roughly leveled and aligned in azimuth, this removes gyro alignment errors and cuts the time to a minimum.
- **Coarse leveling** - pitch and roll driven until they are at 90° to each other. The platform is then roughly levelled using either the aircraft frame as reference, or using the outputs from gravity switches or the horizontal accelerometers.
 - Coarse azimuth alignment - is achieved by turning the platform until the heading output agrees with the aircraft's best known True Heading.
 - Coarse alignment level and aligns the platform within 1° - 2° in a few seconds.
- **Fine leveling** - with zero output from the accelerometers fine levelling is achieved. The process takes anything up to 1 to 1½ minutes, levelling the platform to within 6 seconds of arc.
- **Gyro compassing** - the platform can be aligned in azimuth by connecting the gyro normally used to stabilise the platform about an East-West axis, to the azimuth gimbal motor. With the platform correctly aligned in azimuth the East gyro should not be subject to rotation of its input axis due to earth rotation; when the platform is out of alignment the East gyro will detect a component of earth rotation and the resultant output signal can be used to torque the azimuth gyro until the table is aligned.
- Accelerometers must be levelled (velocity set to zero).
- Platform must be orientated to True north - gyro compassing (position verified).

SCHULER PERIOD

Schuler postulated an earth pendulum with length equal to the radius of the earth, it's bob at the earth's centre and point of suspension at the earth's surface. If the suspension point were accelerated around the earth, the bob would remain vertically below the suspension point because it is at the earth's centre of gravity.

A platform mounted on the suspension point tangential to the earth's surface, ie horizontal would therefore remain horizontal irrespective of the acceleration experienced.

The vertical defined by the normal to the platform is therefore unaffected by acceleration. If, for any reason the bob on the earth pendulum became displaced from the earth's centre, the pendulum would start to oscillate. The oscillation period would be 84.4 minutes.

The INS stable element is maintained normal to the local vertical by feeding back the aircraft's radial velocity as levelling gyro signals, and in this way the North and East accelerometers are prevented from detecting components of the gravity acceleration.

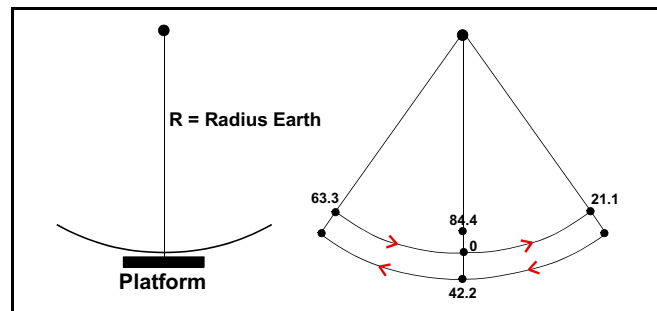

Figure 17.15 The Schuler Period

The control signals are the V/R and U/R terms for vehicle movement. By mechanising the platform to remain horizontal, an analogue of the earth pendulum of period 84.4 minutes is produced. Should the platform be displaced from the horizontal it would oscillate with a period of 84.4 minutes, which is known as the Schuler Period.

ERRORS OF INS

Errors can be conveniently considered under the following headings:

Bounded errors

- Unbounded errors
- Inherent errors

BOUNDED ERRORS

Errors which build up to a maximum and return to zero within 84.4 minutes Schuler cycle, are termed bounded errors. The main cause of these errors are:

- Platform tilt due to initial misalignment
- Inaccurate measurement of acceleration by accelerometers
- Integrator errors in the first stage of integration

UNBOUNDED ERRORS

Unbounded errors - are either cumulative track errors or distance errors:

- Initial azimuth misalignment of the platform
- Wander of the azimuth gyro

Errors which give rise to cumulative errors in the recording of distance run:

- Wander in the levelling gyros. This causes a Schuler oscillation of the platform but the mean recorded value of distance run is increasingly divergent from the true distance run.
- Integrator errors in the second stage of integration.

INHERENT ERRORS

The irregular shape and composition of the earth, the movement of the earth through space and other factors provide further possible sources of error. Such errors vary from system to system depending upon the balance achieved between accuracy on one hand and simplicity of design, reliability, ease of construction and cost of production, on the other.

INS CONTROL AND DISPLAY PANELS

There are many makes and models of INS currently on the market. The “state-of-the-art” trend is towards a single control/display unit with a standard keyboard, but with a single small video screen (rather than the various individual LED windows which are shown in the following illustrations). With the modern video screen presentation, the loading and extraction of information is achieved by selecting a “page number”, with each page (which is displayed on the screen) dealing with associated functions. One major advantage of this type of system is that hundreds or even thousands of waypoints can be “stored” in the machine memory. These waypoints (normally airway reporting points such as VORs and intersections) are automatically loaded from a master disc, which is supplied and regularly updated by specialist agencies.

Because of the high capital investment which was involved in the last generation of INS systems, and because they are proving to be extremely reliable, you are perhaps more likely to encounter the traditional type of control/display units described below. Another good reason for considering this system, rather than the modern one, is that the JAA examination questions are based on the older type of INS.

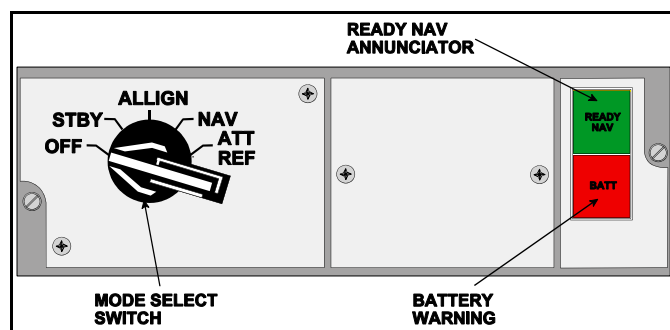

Figure 17.16 Mode Selector Unit

In any event, please appreciate that the following paragraphs are intended only as a general guide and not as a definitive operating instruction for any particular model of INS.

The traditional INS system employs two panels for control and display. The simpler of the two, the mode selector panel, is shown at Figure 17.16.

The function of the mode selector panel is straightforward:

- In the standby mode the power is supplied to all parts of the system. It is normal to insert the start position (the aircraft’s ramp position in lat/long to the nearest tenth of a minute of arc) whilst the equipment is in this mode.
- In the alignment mode the platform is levelled and aligned (gyro-compassed), and when these processes are complete and **READY NAV** illuminated. The equipment can now be switched into the Nav mode, and the aircraft is free to taxi without degrading the accuracy of the INS.

- There may be occasions when full navigation computing is not available but the gyros are serviceable. This could be in the event of a computing malfunction so that earth rate and transport wander corrections cannot be calculated or it could be after an alignment failure in flight.

However, on many aircraft the gyros are used as primary attitude information as well as for inertial navigation and it may be possible to retain gyro information. This is done by selecting ATT REF on the MSU.

Selecting ATT REF disconnects computing and loses alignment, if this has not already happened anyway. The accelerometers now act as gravity switches, as they do during the levelling phase of alignment and the gyros become gravity-tied in the long term - earth gyros. The system now gives attitude information and a limited form of heading. The gyros are normally very accurate, but there is no correction for earth rate and transport wander and the heading needs to be reset periodically to an independent (usually magnetic) source. In effect, the gyros are acting a super-accurate form of DGI and as an attitude indicator.

Should the aircraft electrical supply to the INS cease for any reason the INS will automatically switch to its own battery pack. For as long as a satisfactory level of power is being supplied by the internal battery, the INS Bat light will be illuminated on the Control and Display Unit. As the power from the battery starts to fail, the Bat warning light on the Mode Selector Unit will illuminate, indicating that the INS is about to fail. If you are half way across the Pacific Ocean at this time, this could spoil your whole day, since of course the INS cannot be re-levelled and/or re-aligned in flight (for this the aircraft must be stationary, and the exact position known). The control/display unit (CDU) is shown at Figure 17.17.

The reader who has completed his or her studies of the radio syllabus will undoubtedly notice the similarity between this CDU and the control/display panel of a similar vintage VLF/Omega receiver. Although the inputs for the two equipments are vastly different, the presentation of navigational information to the pilot is more or less identical in both cases.

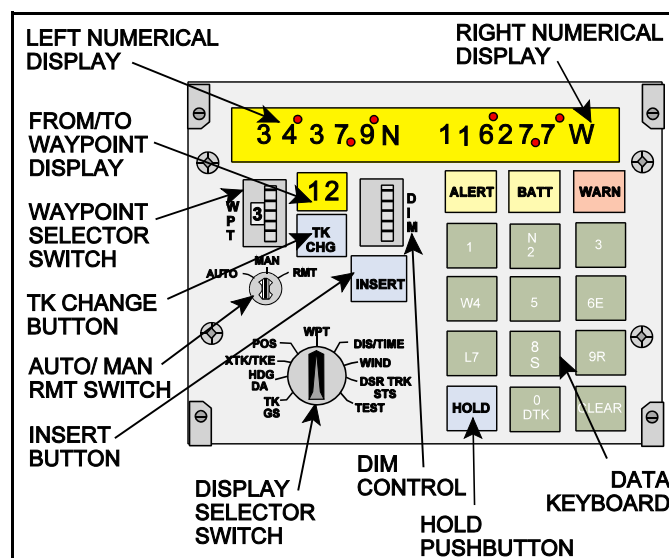

Figure 17.17 Control Display Unit (CDU)

As already mentioned, these notes are not intended as an operator's brief, but rather to help you pass an examination. Please appreciate that, although other INS panels may look dissimilar to the one shown at Figure 17.17 the information given by the system will be basically the same.

Using the panel shown at Figure 17.17 lets start at the top left hand corner and look at the function of each of the displays and controls.

The two large windows at the top of the panel (labelled left and right numerical displays) comprise the principal outputs of the system. Glance now at the function selector (bottom left hand corner), we'll start with the selector in the seven o'clock position (TK/GS) and work anti-clockwise through the functions considering the values shown in the two LED windows as we go.

The waypoint selector switch is thumbed to the appropriate waypoint number (shown in the window to the left of the thumbwheel) when loading the waypoint lat/longs before flight, reloading new waypoints in flight, or checking that waypoints are correctly loaded.

The **FROM/TO** waypoint display shows the two waypoints between which the INS assumes that it is flying. All digital readouts flight director displays and autopilot commands will be based on this information, and so you can imagine the consequences of either giving the equipment the wrong to/from waypoint numbers or feeding the system with the wrong waypoint lat/long to begin with.

The Track change push button enables the operator to tell the system between which two waypoints the aircraft is required to fly (in the event that the system is not set up to fly sequentially through the loaded waypoints).

The Dim control governs the brightness of the LED displays and the panel lighting.

The Alert annunciator warns the operator that the aircraft is approaching the next waypoint. In **AUTO** mode the alert light will come on, steady, 2 minutes to run to the waypoint, and will extinguish as the track changes overhead the waypoint. In **MANUAL** mode the alert light will come on, steady, 2 minutes to run to the waypoint; the light will then flash 30 seconds before the waypoint, and will continue to flash until the track is changed. The annunciator will not illuminate below a set speed (typically either 100 kts or 250 kts).

The Battery annunciator will illuminate when the INS is operating on internal power.

The Warning annunciator illuminates when a system malfunction occurs.

The Auto/Manual/Remote switch determines the level of pilot intervention necessary to fly the aircraft. In the automatic mode the INS will automatically switch from one track to the next as each waypoint is overflown. In the manual mode the operator is required to update the waypoint from/to readout as each waypoint is overflown. The exact function of the remote position will depend on the complexity of the INS computer programme, and is outside the scope of this syllabus but in general terms it allows for simultaneous insertion of waypoints into more than one INS from one CDU.

The Insert pushbutton is used in conjunction with the data input keyboard to enter information into the system.

Finally, the Hold pushbutton is used primarily for updating the INS position when overflying a reliable fix, such as a VOR overhead. The **HOLD** button is depressed as the fix is overflown the function switch is placed in the POS (position) mode, the exact lat/long of the radio fix (in this case the lat/long of the VOR) is punched into the machine, and the hold button is then released. Appreciate that if this is done, the radial error rate assessment (discussed shortly) will be invalid, unless the position update vector is accounted for.

SUMMARY INS WARNING LIGHTS

	LIGHT INDICATION	ACTION REQUIRED
READY NAV (MSU)	Green light, indicates alignment complete.	Select 'NAV'
BATT (MSU)	Red light, indicates battery power too low for operation.	Check power supplies
ALERT (CDU)	Amber light, indicates approaching (overflying in a MAN) a waypoint.	None, unless in MAN mode when TK CHG is initiated
BATT (CDU)	Amber light, indicates INS operating on back up power.	Check power supplies.
WARN (CDU)	Flash red light, indicates system malfunction.	Set selector to DSR TK/STS note action code and consult users guide for appropriate action.

LED DISPLAY

Note: All of the following descriptions are based upon a Desired Track between waypoints of 060°.

Track & Groundspeed

The INS derived aircraft track (°T) is shown to the nearest tenth of a degree in the LH window.

The INS derived groundspeed is shown to the nearest knot in the RH window.

The track is 040°T and the groundspeed 502 kts at Figure 17.18.

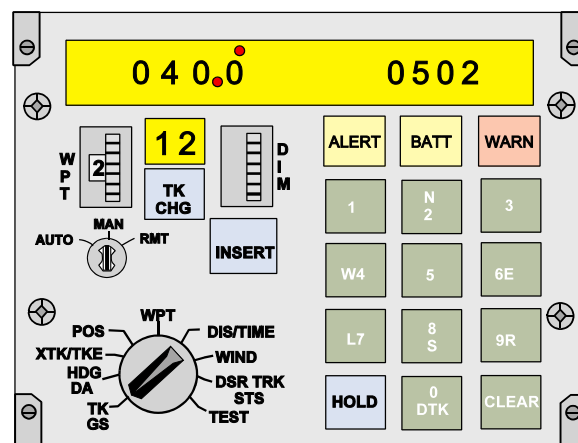
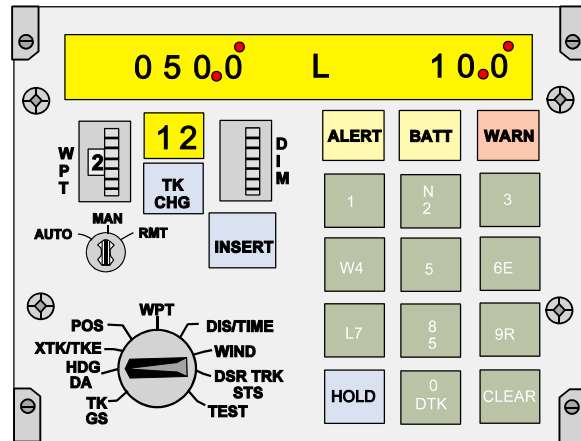

Figure 17.18 TK / GS (Track and Groundspeed)

Heading & Drift

The INS derived true heading (the angle between the north-south axis of the platform and the aircraft fore and aft axis in a north aligned system) is shown to the nearest tenth of a degree in the LH window.

The INS derived drift angle is shown to the nearest tenth of a degree is shown in the RH window, and is preceded by an L(left / port drift) or an R(right / starboard drift).



The heading is 050°T and the drift 10°. Figure 17.19 HDG / DA (Heading and Drift Angle)

Cross Track Error & Track Keeping Error

XTK/TKE (Cross track distance and track error angle). The cross track distance (the displacement of the aircraft perpendicularly from the direct great circle track between the two waypoints selected) is shown to the nearest tenth of a nautical mile in the LH window. This figure is preceded by an L or an R to indicate that the aircraft is left or right of the direct track.

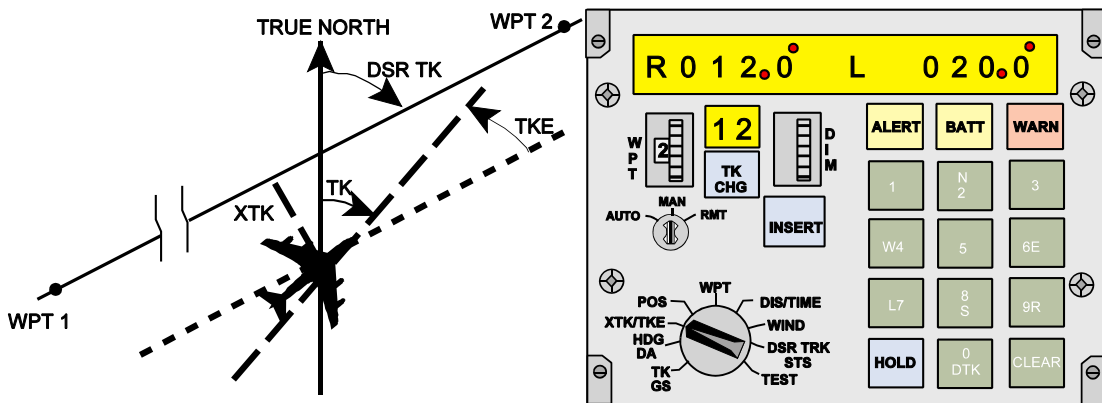

Figure 17.20 XTK / TKE (Cross track distance and track error angle)

The track angle error (the angle between the track which the aircraft would require to make good were it flying along the great circle route between the specified waypoints and the track which it is actually making good) is shown to the nearest tenth of a degree in the RH window. The L or R which precedes this value indicates that the actual track is to the left or right of the required track. In this case, remembering that we desire a track of 0600, we must be “making good” a track of 0400 because we have an indication that we are tracking 200 to the left of our desired track between consecutive waypoints.

In summary the cross track error is 12nm to the Right and the track angle error is 20° to the Left in the situation also shown at Figure 17.20

Present Position

The aircraft's present latitude is shown to the nearest tenth of a minute of arc in the LH window.

The aircraft's present longitude is shown to the nearest tenth of a minute of arc in the RH window.

The aircraft's position is therefore shown as 34°31.5'N 117°11.3'W.

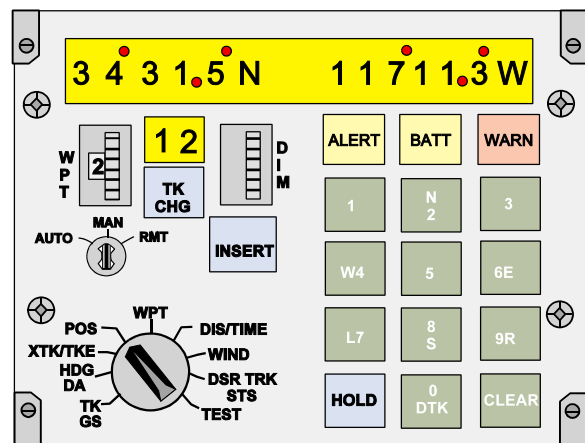

Figure 17.21 POS (Present position)

Waypoint Positions

The waypoint positions are shown in Latitude (LH window) and Longitude (RH window) to the nearest tenth of a minute of arc.

In the system which we are considering there are 10 possible waypoint selections (0 through 9). Waypoints 1 through 9 are simply selected turning points, and are normally placed into the system by the operator before the flight.

Waypoint 0 represents the aircraft's position at the last time a track change from present position to a specified waypoint was selected by the operator.

Waypoint 4 shown as 36°01.4'N 115°00.0'W

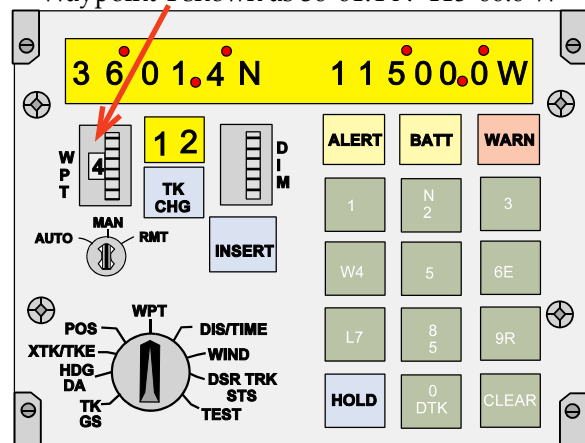

Figure 34.22 WPT (Waypoint positions)

Let us consider briefly how this could be useful.

Suppose that you are half way between, say, waypoints 3 and 4 and air traffic control clear you direct to waypoint 6. By selecting a track change from waypoint 0 (the aircraft's present position) to waypoint 6 and inserting it, the aircraft will fly you to directly to Wpt 6 if coupled to the flight director/autopilot.

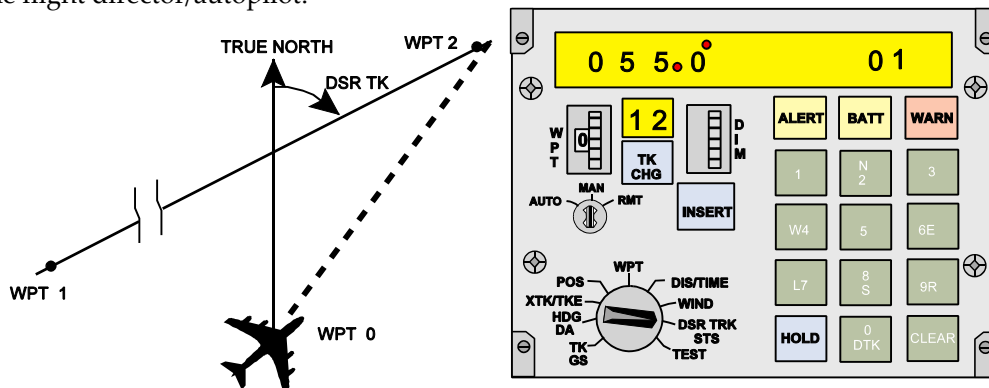

Figure 17.23 Waypoint Zero

Waypoint Zero is reserved for the computer to establish a track from the aircraft's present position and will not accept operator entered waypoint coordinates.

Distance and Time

The distance to go from the aircraft's present position direct to the next selected waypoint is shown to the nearest nautical mile in the LH window.

The lapsed time from the aircraft's present position to the next waypoint is shown to the nearest tenth of a minute in the RH window.

The distance to go here is shown as 140nm and the time as 16.7 minutes.

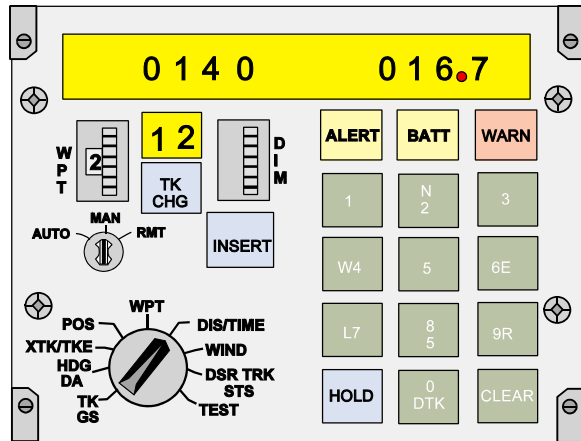

Figure 17.24 DIS / TIME

Wind Speed and Direction

The INS derived wind direction (°T) is shown to the nearest degree in the LH window.

INS derived wind speed is shown to the nearest knot in the RH window.

The W/V is shown as 155°(T)/85 kt.

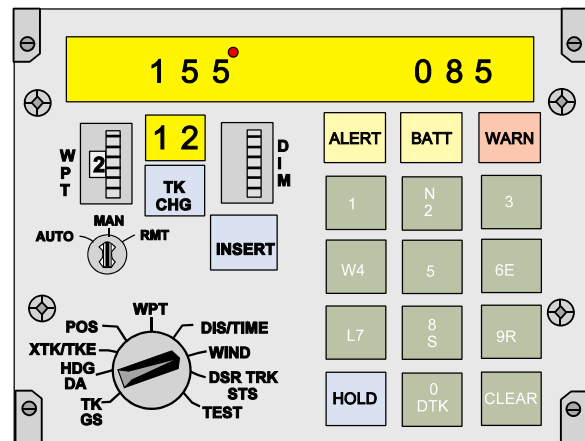

Figure 17.25 WIND (Wind velocity)

Desired Track and Status

The desired track (assuming that the aircraft is on the direct great circle track between the two selected waypoints) is shown in degrees true to the nearest tenth of a degree in the LH window.

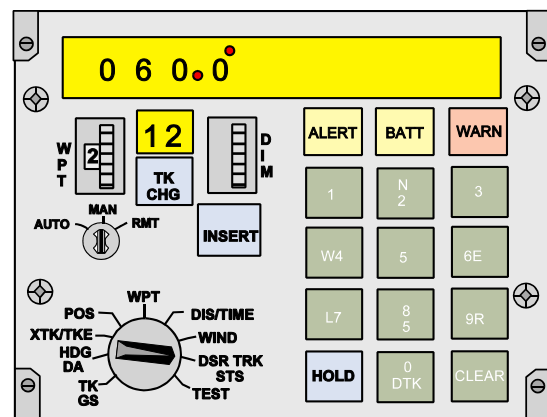
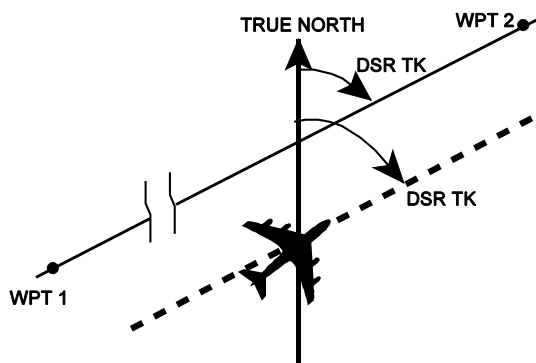

Figure 17.26 DSR TK / STS (Desired track and status)

The RH window will normally be blank, since the status check is generally only available with the equipment in the alignment mode.

The desired track is $060.0^\circ(T)$ which allows us to see the relationship between the aircraft's current position and track and the direct track between the two selected waypoints. You may by now have reached the conclusion that the programme upon which the INS computer operates assumes that the INS will normally operate coupled to the flight director / autopilot, so that across track errors do not occur.

Test

The diagram at Figure 17.27 shows the function switch in the test position resulting in all of the digits on the various displays being illuminated either showing a figure or letters. This enables the operator to check that all of the functions are operating.

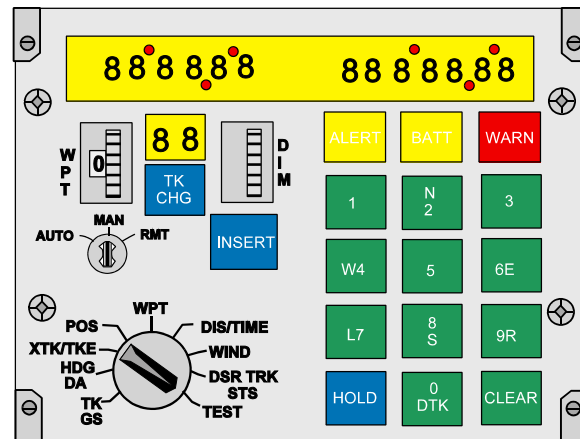

Figure 17.27 TEST (Light emitting diode test)

MANUAL AND AUTOMATIC SYSTEM CHECKS

At the initial setting up stage the start position must be fed into the INS computer with a high degree of accuracy. If the initial latitude is slightly in error the platform will not remain Earth horizontal once the equipment is switched into the navigation mode, since the torque motors will be tilting the platform at an inappropriate rate, due to computer calculations based on incorrect latitude. Likewise, and for the same reasons, the platform will not remain directionally aligned with respect to north.

If the initial latitude setting is grossly in error the system will detect the error and warn the operator (this is one of the principal functions of the warning annunciator on the CDU whilst the equipment is in the align mode). The equipment is able to sense a gross latitude input error since the apparent drift and topple rates sensed by the rate gyros will not correspond to the corrections being applied by the torque motors.

An incorrect operator input of longitude will not affect the stability of the platform, but obviously the track and distance from the departure point to the first waypoint will be incorrectly computed. Furthermore, all subsequent indications of longitude will be in error by the amount of the initial input error.

An incorrect input of the lat / long of any of the waypoints will have serious consequences. The INS will navigate very accurately between waypoints, but it is incapable of detecting operator malfunctions (finger trouble)! In order to check that the waypoints have been correctly inserted they should be recalled from store onto the LED display, and rechecked before flight.

A second check is to call up the initial great circle track(TK / GS) and distances(DIS / TIME) between consecutive waypoints, and to compare these values against those shown on the flight log/flight progress log/flight plan.

QUESTIONS

1. INS errors are classified as “Bounded errors” and “Unbounded errors”.
 - a. An “Unbounded error” is an error that increases with time, an example being the distance gone error due to a ground speed error.
 - b. An “Unbounded error” is an error that increases with time, an example being an increasing ground speed error due to the platform not being levelled correctly.
 - c. A “Bounded error” is an error that is subject to sudden unpredictable random changes. Most notable during pitching manoeuvres and when raising or lowering flap and U/C.
 - d. A “Bounded error” is an error that is “tied” to the real wander rates of the gyros on the platform.
2. Two checks that can be carried out to check that two selected sequential waypoints have been entered correctly are:
 - a. select DSR.TK/STS and check that the status is less than 4; select DIS/TIME and check that the time agrees with the flight plan time.
 - b. select DIS/TIME and check that the distance agrees with the distance on the flight plan; then check that the time agrees with the flight plan time for the leg.
 - c. select DIS/TIME and check that the distance agrees with the distance on the flight plan; select DSR.TK/STS and check that the track agrees with the flight plan track for the leg.
 - d. select DIS/TIME and check that the distance agrees with the distance on the flight plan; select HDG/DA and check that the heading agrees with the flight plan heading for the leg.
3. In an INS the E/W accelerations are converted into an E/W speed (kt) at the first stage of integration and into E/W distance gone (nm) at the second stage of integration. This gives:
 - a. departure which is multiplied by Cosine of the present latitude of obtain d'long (min) which is used to automatically up-date the present longitude.
 - b. d'long (min) which is used to automatically up-date the present longitude.
 - c. departure which is multiplied by Secant of the present latitude to obtain d'long (min) which is used to automatically up-date the present longitude.
 - d. departure which is multiplied by Sine of the present latitude to obtain d'long (min) which is used to automatically up-date the present longitude.
4. At the second stage of integration E/W speed is converted into E/W distance gone. To convert this departure into change of longitude is has to:
 - a. be divided by Secant of the latitude.
 - b. be multiplied by Secant of the latitude.
 - c. be divided by Tangent of the latitude.
 - d. be multiplied by Cosine of the latitude.

5. The amber ALERT light on an INS control and display unit:
- illuminates steadily 2 minutes, in AUTO mode, before reaching the next waypoint.
 - start flashing 2 minutes before reaching the next waypoint and goes out at 30 seconds to run.
 - illuminates if power from the aircraft bus bar has been lost and the system is operating on standby battery.
 - illuminates steadily after passing a waypoint in manual mode, until the next leg is programmed in.
6. With reference to Inertial Navigation Systems, the functions of the integrators are:
- at the second stage of integration to suppress unbounded errors (when in the NAV mode).
 - at the first stage of integration to convert acceleration, with respect to time, into speed, (when in NAV mode).
 - at the second stage of integration to convert speed, with respect to time, into distance gone, (when in the NAV mode).
 - to align the platform (when in the level and align modes).
- all the above statements are true.
 - only (ii), (iii) and (iv) of the above statements are true.
 - only (i), (ii) and (iii) of the above statements are true.
 - only (ii) and (iii) of the above statements are true.
7. The computer of a north referenced Inertial Navigation System (INS) in flight, provides compensation for:
- aircraft manoeuvres, real wander, apparent wander, transport wander.
 - coriolis, real wander, apparent wander, transport wander.
 - earth rotation, transport wander, coriolis.
 - transport wander, apparent wander, coriolis, magnetic variation.

The diagram below shows the situation after an aircraft, equipped with INS, has passed over waypoint 2 and is tracking along the line TK (dashed).

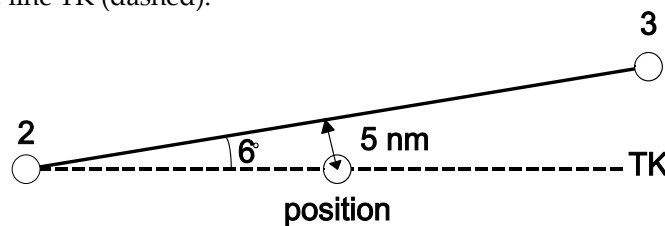

Using the information given in the diagram and the fact that with DA/HDG selected on the control and display unit (CDU) of the INS, the display shows 6L/080, answer the following two questions:

8. When DSRTK/STS is selected on the CDU, the left window will show:
- 074
 - 086
 - 068
 - 080

9. When XTK/TKE is selected on the CDU, the display will show (to the nearest whole number):

	LEFT DISPLAY	RIGHT DISPLAY
--	--------------	---------------

- | | | |
|----|----|----|
| a. | 5L | 6R |
| b. | 5R | 6R |
| c. | 5L | 6L |
| d. | 6R | 5L |
10. During initialisation of an INS the aircraft must not be moved until:
- The ramp position has been inserted and checked.
 - The platform is levelled.
 - The gyros and accelerometers are in the "null" position.
 - The green "ready NAV" light has been illuminated and the mode selector switch has been set to the "NAV" position

ANSWERS

- 1 A
- 2 C
- 3 C
- 4 B
- 5 A
- 6 D
- 7 C
- 8 C
- 9 B
- 10 D

CHAPTER EIGHTEEN
INERTIAL REFERENCE SYSTEM

Contents

INERTIAL REFERENCE SYSTEM251
INERTIAL NAVIGATION.251
INERTIAL REFERENCE UNIT.252
INERTIAL INFORMATION252
THE PRIMARY SOURCES OF INFORMATION252
THE LASER GYRO.253
PRINCIPLES OF LASER GYROS AND IRS.253
CONSTRUCTION AND OPERATION253
LIMITATIONS AND ACCURACY254
PLATFORM / STRAP DOWN PRINCIPLES255
PLATFORM ALIGNMENT255
ADVANTAGES.256
QUESTION256

INERTIAL REFERENCE SYSTEM

The **laser gyro** has caused a technological revolution in the design of **inertial reference** and **navigation systems**. This solid state high precision angular rate sensor is ideally suited for highly reliable strap down system configuration. It eliminates the need for gimbals, bearings, torque motors, and other moving parts, and consequently changes the system operation considerably from conventional **inertial navigation systems**.

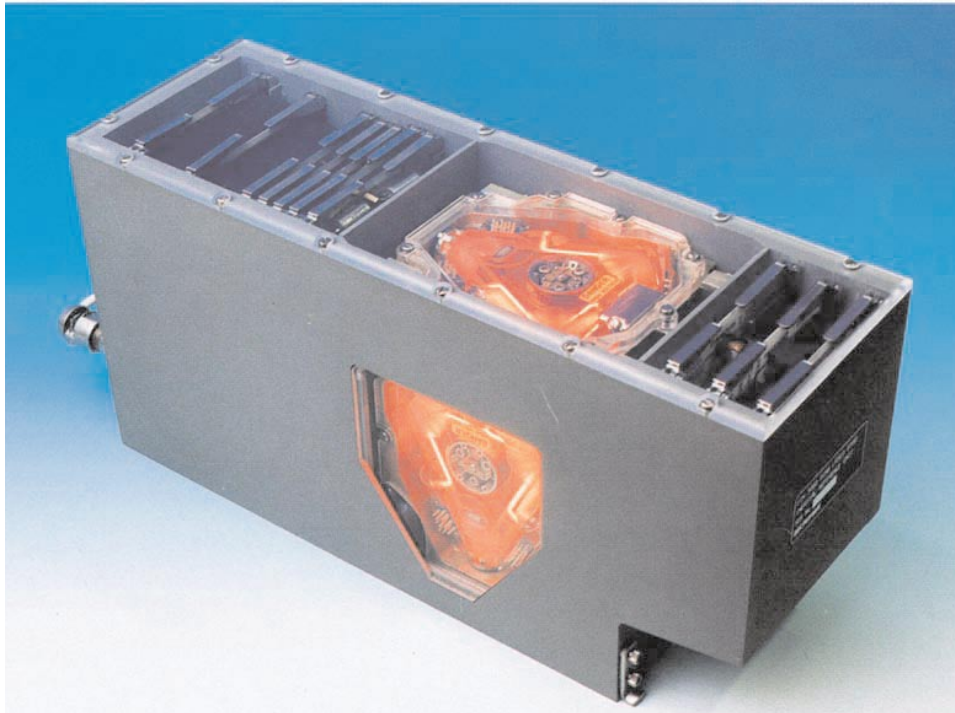

Figure 18.1 GEC-Marconi FIN3060 Commercial Aircraft Inertial Reference

INERTIAL NAVIGATION

Inertial Navigation means the determination of a vehicles location without the aid of external references. **Strap down inertial navigation** goes a step further by enabling navigation without the use of a mechanically stabilised platform. This has been achieved through the advent of **laser gyros / rate sensors** and powerful, high speed microprocessors. The **laser gyros** allow a micro processor to maintain a stable platform mathematically, rather than mechanically.

INERTIAL REFERENCE UNIT

The **Inertial Reference Unit** (IRU) is the heart of the **Inertial Reference System** (IRS). It provides all required **inertial reference** outputs for the aircraft's avionics.

Outputs are:

Primary attitude	Pitch and roll
Heading	True, Magnetic
Accelerations	Lateral, Longitude, Normal
Angular rates	Pitch, Roll, Yaw
Inertial velocity	N/S, E/W, GS, TA, Vertical rate
Position	Latitude, longitude, inertial altitude
Wind data	Wind speed, wind angle, drift angle
Calculated data	Flight path angle and acceleration Along and across track acceleration Inertial pitch and roll rate Vertical acceleration Potential vertical speed.

INERTIAL INFORMATION

Inertial information is used by:

- Flight management computer
- Flight control computer
- Thrust management computer
- Stability augmentation system
- Weather radar
- Anti skid auto brake systems
- Attitude direction indicator
- Horizontal situation indicator
- Vertical speed indicator
- Radio direction magnetic indicator
- Flight data recorder

THE PRIMARY SOURCES OF INFORMATION

The primary sources of information for the IRU are its own internal sensors three **laser gyros**, and three **inertial accelerometers**. The only other inputs required are initial position, barometric altitude, and True Air Speed (TAS).

Initial position is required because present position is calculated from the distance and direction travelled from the initial start position entered.

Barometric altitude stabilises the vertical navigation, and thereby stabilises the vertical velocity and inertial altitude outputs.

The TAS input allows the IRU to calculate wind speed and wind direction.

THE LASER GYRO

The **laser gyro** is an example of the application that uses the characteristics of light to measure motion. This device operates based on the SAGNAC effect. One beam rotates in one direction and the other beam in the opposite direction. One of the conditions that must be satisfied to maintain **lasing** is that the number of wavelengths in the beams path length must equal a whole number. When the wavelengths change there is a concurrent change in the lights frequency. This means that in a rotating gyro, one laser beam will exhibit an increase in frequency, whereas the other beam will exhibit a frequency decrease. The frequency difference between the two beams is easily and accurately measured along optical paths.

PRINCIPLES OF LASER GYROS AND IRS

Laser (Light Amplification and Stimulated Emission of Radiation) gyros measure rotation by comparing two laser beams created and directed to rotate in opposite directions within a very narrow tunnel. Photons are emitted within the laser cavity in **all directions** but only the light that radiates backwards and forwards between the mirrors is reinforced by repeated trips through the **gain medium**: continued passage amplification soon reaches saturation and a steady state oscillation ensues, a **laser beam**.

CONSTRUCTION AND OPERATION

Construction. The laser gyro contains three mirrors to achieve a **rotational** path for two beams that are generated and sent around in a triangular path in opposite directions. The **lasers** are sent around small tunnels drilled parallel to the perimeter of a triangular block of temperature stable glass with reflecting mirrors placed in each corner.

Lasing is achieved by running high voltages through **helium neon** gas between the anodes and the cathode transforming many of the atoms of the gas into light in the **pinkish orange** part of the visible spectrum (this action is helped by the tuned cavity effect of the tunnel in the glass block).

Operation. The laser beam that is created can be described as a high energy beam of coherent light which is said to be of a **pure frequency**. The light will be reflected by the mirrors but light of **unwanted frequencies** (i.e. not at the design frequency) will be absorbed by the mirrors and their coatings. Because the frequency of the light is known it can be measured and modified by adjustment of the path length i.e. "If the path length is decreased, the light is compressed and the frequency will increase - if the path length is expanded the frequency decreases".

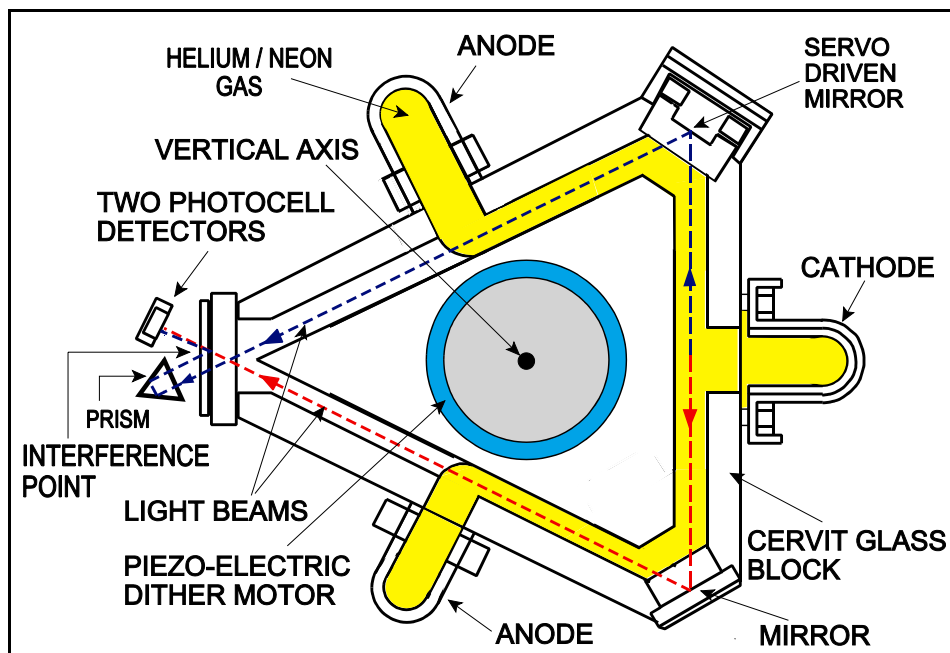

Figure 18.2

The triangular path of the device does not rotate but the two beams of light are caused to travel in opposite directions and will of course travel at the same speed - **the speed of light**.

If there is no movement of the device the beams cancel each other out but when movement is induced one of the beams will take longer to complete its path and the other, in opposition, a measurably shorter length of time to complete its journey. This whole process is measured by devices known as **gain elements** and the rate of rotation can be calculated.

The three mirrors involved are not identical - one makes micro adjustments to keep the physical light path accurately aligned and another is partially transparent to allow the laser light to be detected on the photo cell detectors.

Included with the second mirror is a prism which **flips / redirects** the light beam around causing it to meet and **interfere** with the light beam that is aimed directly at the photo cell. The beams alternately cancel and reinforce each other (known as interference) **thus generating a fringe pattern**.

The photo electric cell detects the direction and speed at which the **fringe pattern** moves. The change in the pattern , moving in one direction or other depends upon which way the **laser gyro** is being rotated. The faster the rotation the faster the **fringe pattern** moves across the photo electric cell - this is then converted to signals used within the aircraft systems.

LIMITATIONS AND ACCURACY

Drift. The principle source of error with this form of device , as with the conventional **gyro stabilised platform INS** device, is associated with random drift. In a conventional gyro this is caused by imperfections of gyro bearings and mass imbalances but with the **laser** system noise is the cause and this is derived almost entirely from imperfections in the mirrors and their coatings.

Accuracy. The accuracy of the **laser** system is directly influenced by the length of its optical path - the longer the path available the greater the accuracy with a small percentage increase in length leading to a substantial increase in accuracy.

Lock in. The most significant potential problem is **lock in**, also known as **laser lock**, which occurs at very low rotation rates.

At very low rotation rates the output frequency can drop to zero as a result of **back scattering** between the two beams which causes the beams to synchronise, that is, no longer indicate the rotation correctly and indeed introduce undesirable errors. This phenomena is overcome by the introduction of a vibration device known as a **piezo electric dither motor** which breaks the lock in. The motor is mounted in such a way that it vibrates the **laser ring** about its **input axis** through the lock in region, thereby unlocking the beams and enabling the optical sensor to detect the smaller movement of the **fringe pattern**. The motions caused by the dither motor are decoupled from the output of the **ring laser gyro / rate sensor**.

PLATFORM / STRAP DOWN PRINCIPLES

Platform. The INS (**platform set in gimbals**) requires three rate integrating gyros and accelerometers to achieve an output that we can use and this process is started by ensuring that the platform is horizontal at the correct Latitude. **IRS (strap down)** attaches the three laser gyro / rate sensors and accelerometers directly to the aircraft chassis.

High speed micro processors then achieve a stable platform **mathematically** rather than mechanically (as per the INS) - this results in greatly improved accuracy and reliability.

Integration. Integration principles are used as per the older INS system.

Gravity. Gravity - the microprocessor subtracts the effect of local gravity from any vertical acceleration to compensate for local effects.

Earth rotation. Earth Rotation Rate - compensated for at the rate of 15.04 degrees as with a gyro (INS) system.

Transport compensation. Transport Rate - **Schuler Tuning** is again required to compensate for oscillation errors as the system is transported over the Earth (this in relation to pendulum theory which results in an 84.4 minute error cycle as described in the older INS).

Calibration. Automatic Calibration - completed automatically by computer to enhance the overall accuracy of the system.

PLATFORM ALIGNMENT

True North. The system, as with the INS, requires to find **true north** to achieve an alignment and this is achieved when the aircraft is stationary on the ground and the only rate of change is that associated with the movement of the Earth. True North is then found.

Latitude. Initial Latitude must be put into the system by the operator, the computer then, after assessing the rotational vectors that it is experiencing compares the Latitude it finds with that entered by the operator during initialization. However, it should be noted that with this system the inbuilt memory function remembers its position at landing and will indicate to the crew any errors of initial position input (lat'or long') upon startup.

Alignment. The computer, after confirming the Latitude, completes a full mathematical levelling process - initial Latitude and Longitude must be entered manually as a **present position** to assist this align - **THE AIRCRAFT MUST NOT BE MOVED DURING THIS PROCESS.**

This process is called **Establishing the Trihedron.**

ADVANTAGES

Activation. Almost no spin up time, one second activation for the rate sensor.

Manoeuvring. Insensitive to "G" attitude, rolling, pitching manoeuvres.

Construction. Mechanically simple and highly reliable.

Range. Wide dynamic range.

Drift. Very small drift rates - greatest errors induced by the operator.

QUESTION

Dither is used in a laser gyro in order to:

- a. Enhance the accuracy of the gyro at all rotational rates.
- b. Increase the maximum rotational rate that can be sensed by the gyro.
- c. Stabilise the laser frequencies at peak power output.
- d. Break the frequency lock which would prevent small rotational rates from being sensed by the gyro.

Correct answer d.

CHAPTER NINETEEN

AIR DATA COMPUTER

Contents

INTRODUCTION259
PITOT - STATIC SYSTEM259
AIR DATA COMPUTER.259
SYSTEM REDUNDANCY261
BUILT IN TEST EQUIPMENT (BIT OR BITE).262
ADVANTAGES OF AN AIR DATA SYSTEM..262

INTRODUCTION

In many large aircraft currently in service, the conventional pressure instruments which show altitude, airspeed and Mach Number(MNo) are replaced by indicators displaying information generated by a central computer, the Air Data Computer (ADC). The computer unit and displays, together with the sensors of the basic data of pitot pressure, static pressure and air temperature, and a power-pack, form the aircraft's Air Data System (ADS). Whilst such a system is self-contained, its outputs are essential to the operation of the aircraft's Automatic Flight Control System (AFCS). ADS outputs may also be used in the altitude transponder, flight data recorder, navigation computer and more.

A number of different aircraft types may use the same basic Air Data Computer and this device will need to be integrated into the aircraft systems and this is achieved by a "**Configuration Module**". The module can be calibrated to take into account differences in pressure / temperature gathering efficiencies due to positioning of the gathering probes and this information can then be entered into the computer to obtain the most accurate indications possible.

The standard ADS instruments show altitude, vertical speed, airspeed and MNo. Additional instruments can display Total Air Temperature (TAT), Static Air Temperature (SAT) and TAS. The ADC outputs required for other systems are various and may include TAS, Altitude, Log Mach No, Reciprocal Mach No and Log Vertical Speed. The ADC fitted to Concorde computes Angle of Attack and Side-slip as well as more standard data. A schematic diagram of a conventional ADS is shown in Figure 19.3.

PITOT - STATIC SYSTEM

In a typical aircraft, identical sets of air data instruments are provided on the Captain's and First Officer's instrument panels. Each set of instruments is connected to one of two (allowing redundancy) ADC's fed from independent pitot and static sources, which can be cross connected, as shown in Figure 19.2. In addition to the indicators powered by the two ADC's there is a standby barometric altimeter and a standby airspeed indicator, fed direct from pitot and static sources separate from those used for the ADC's. Each of the three independent pitot-static systems makes use of cross coupled static vents located on each side of the fuselage. This arrangement is designed to reduce error due to side-slip or yaw.

AIR DATA COMPUTER

The Air Data Computer in current aircraft is a device that uses analogue or digital computing techniques to convert pressure and temperature data into electrical signals which are transmitted to the display instruments and to other systems.

The two types of ADC system found are described as either **Analogue** or **Digital** from the method of assessment and transmission of information used.

The Analog type uses continuous physical variables, such as voltage or pressure, to assess and represent the measurements obtained. The illustration at **Fig 19.1a** shows an Airspeed assessment device from an **Analogue ADC** indicating the inputs of Static and Pitot Pressure. The pressures are joined together mechanically and, using a **Pressure Transducer**, transmitted forward for use through the rotation of a shaft driven by a 2-phase Servo Motor which in turn is connected to a CX Synchro where angular position can be measured and read off as an airspeed.

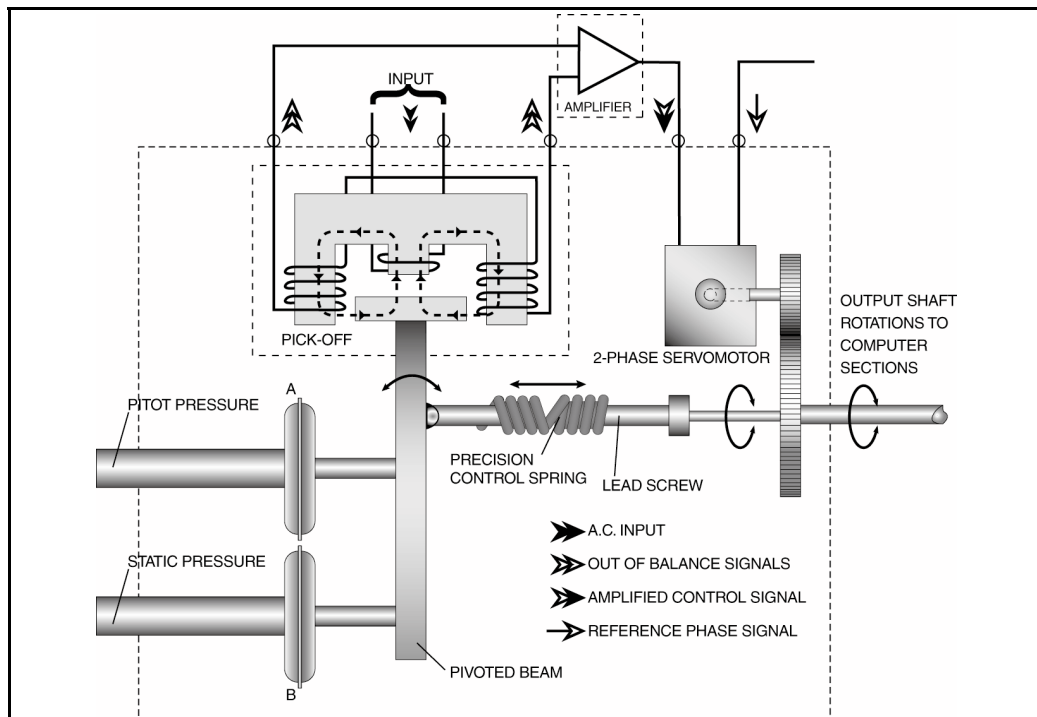

Figure 19.1 Analogue ADC - Airspeed Assessment

An Analogue Air Data Computer may internally be split into the following modules for assessment and onward transmission of data obtained through the Temperature, Static and Pitot Pressure gathering devices - **Altitude, Computed Airspeed, Mach speed, True Air Speed** and using data from the altitude module via a **Rate of Climb** module will give vertical speed.

The relationships between TAS, Mach No, Temperature, Pitot and Static pressures can be expressed as mathematical formulae. The ADC resolves these formulae continuously to produce the required outputs from pressure and temperature inputs in the form of shaft rotations or electrical signals.

The Digital system uses digital data (binary data) in its assessment and transmission of information. The **Analogue to Digital Converters**, at the input side of the ADC, use measurements of Pressure, Temperature and AOA and change them from the Analogue form to Digital form for use within the ADC and onward transmission to the flight deck.

(Both forms of computer system are discussed in the lessons relating to Basic Computers elsewhere in the course.)

SYSTEM REDUNDANCY

Provision for blockages and / or failure of an ADC is made through change-over cocks that permit an alternative static source to be connected to the computer or by the use of electrical switching that enables the Captain's instrument to be fed from the First Officer's ADC and vice versa. These arrangements are illustrated in Figures 19.2 and 19.4.

In some aircraft the ADS is designed so that the outputs from each computer are not directed exclusively to instruments on one side of the panel. By mixing the sources of air data to each side, the possibility of an undetected malfunction is reduced.

In the event of total failure of both ADC's due perhaps to loss of power supply, the flight can be continued by reference to the standby instruments.

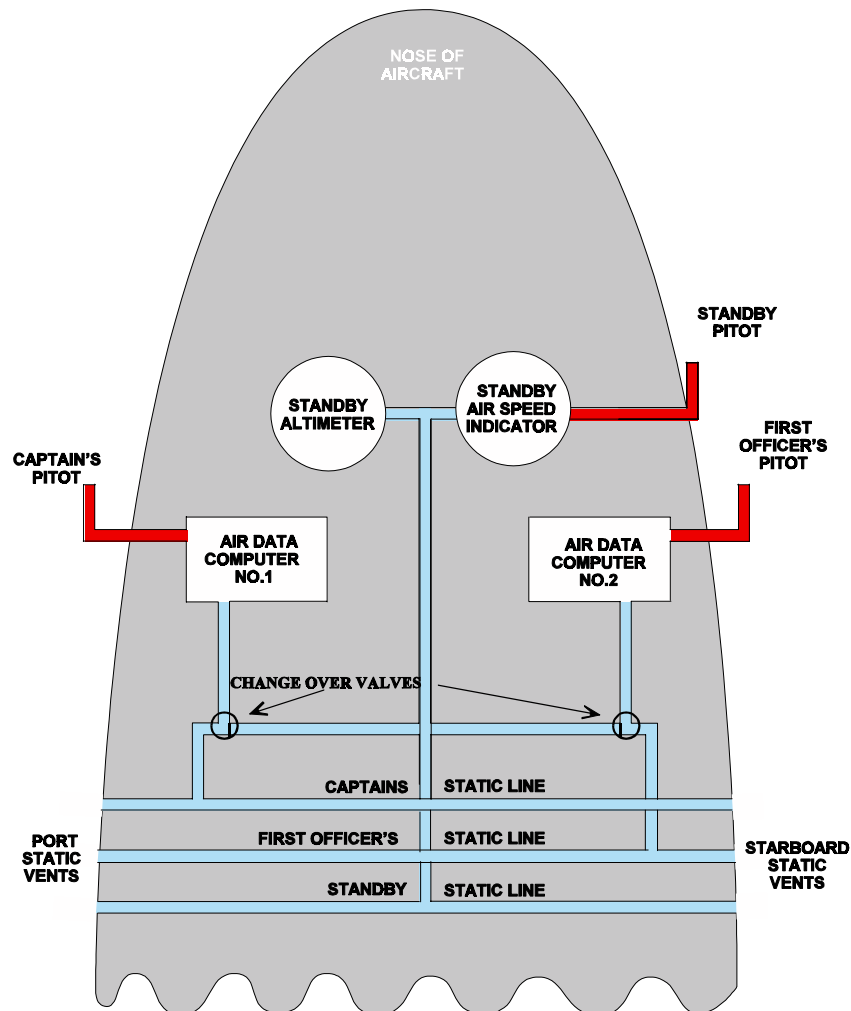

Figure 19.2

BUILT IN TEST EQUIPMENT (BIT OR BITE)

There is no provision made for the manual input of data into the ADC in the event of any failure, but the Built In Test Equipment will give prompt indication of any malfunction that might occur. (See 'Failure Warning' below). In any ADC there will be three types of BITE process:

Power Up BITE

This functions when power is applied to the ADC on start up or after a break. A check is made on the Microprocessor, the Memory Store and the Air Data functions.

Continuous BITE

This is an automatic check of all stages of input and output carried out throughout the operation of the ADC about once every second.

Maintenance BITE

This enables maintenance crew to carry out checks on the ground using a Test or Test/History switch (current or post failures).

ADVANTAGES OF AN AIR DATA SYSTEM.

An ADS has certain advantages when compared with conventional mechanical instruments:

Improved Displays

Electrically-servoed instrumentation allows the manufacturer complete freedom to design new displays that are easier to read and unambiguous. These include digital, moving tape and combined displays.

Reduced Instrument and Lag Errors

The major cause of instrument error in conventional mechanical instruments is friction loss within the linkage. The limited response rate of such linkages gives rise to lag error. Both problems are largely overcome with ADS's by the use of servomotors.

Error Correction

Computation of height, airspeed and other variables within one computer permits error corrections to be applied through especially shaped cams appropriate to the particular aircraft. For example, position error correction (PEC) can be calculated within the Mach No computer channel for additional use within the height and airspeed channels.

Central Source for Other Systems

The ADC provides not only the conventional information displayed on the instrument panel but also air data in many forms as required for other systems.

Clean Design

The use of electrically-driven instruments reduces the amount of pneumatic plumbing required behind the instrument panel to only those lines connected to the standby airspeed indicator and altimeter. In addition to space saving and easier maintenance, the use of shorter pitot/static line reduces error-producing acoustic effects.

Failure Warning

A comparison monitor can be incorporated to compare the outputs of the ADC's and to give automatic warning to the pilot of malfunction. With a purely mechanical system, comparison between left-hand and right-hand instruments must be carried out visually. A warning flag will appear on the appropriate ADS instrument if there is loss of valid data or if an internal failure occurs. In addition, a light will illuminate either on the instrument warning panel or on the central warning system indicator

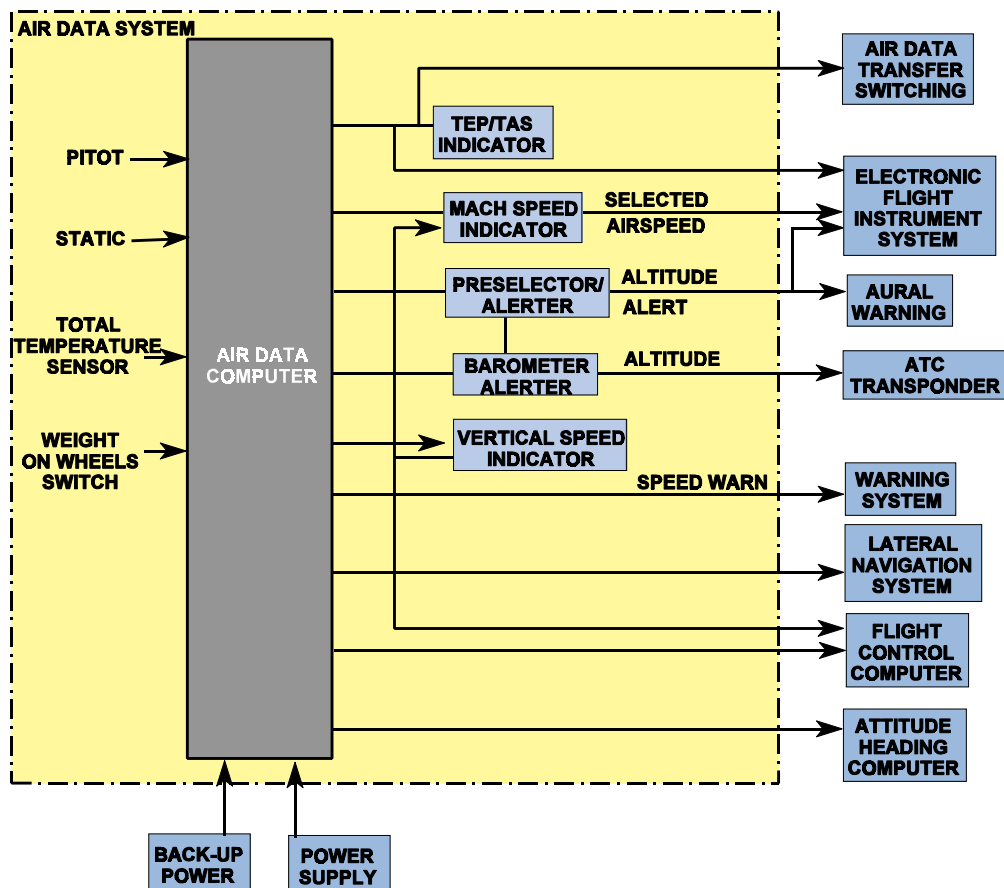

Figure 19.3 Conventional System

Notes: The weight on wheels switch decouples the stall warning system when the aircraft is on the ground.

AOA may also be an input to the ADC for use in some aircraft systems.

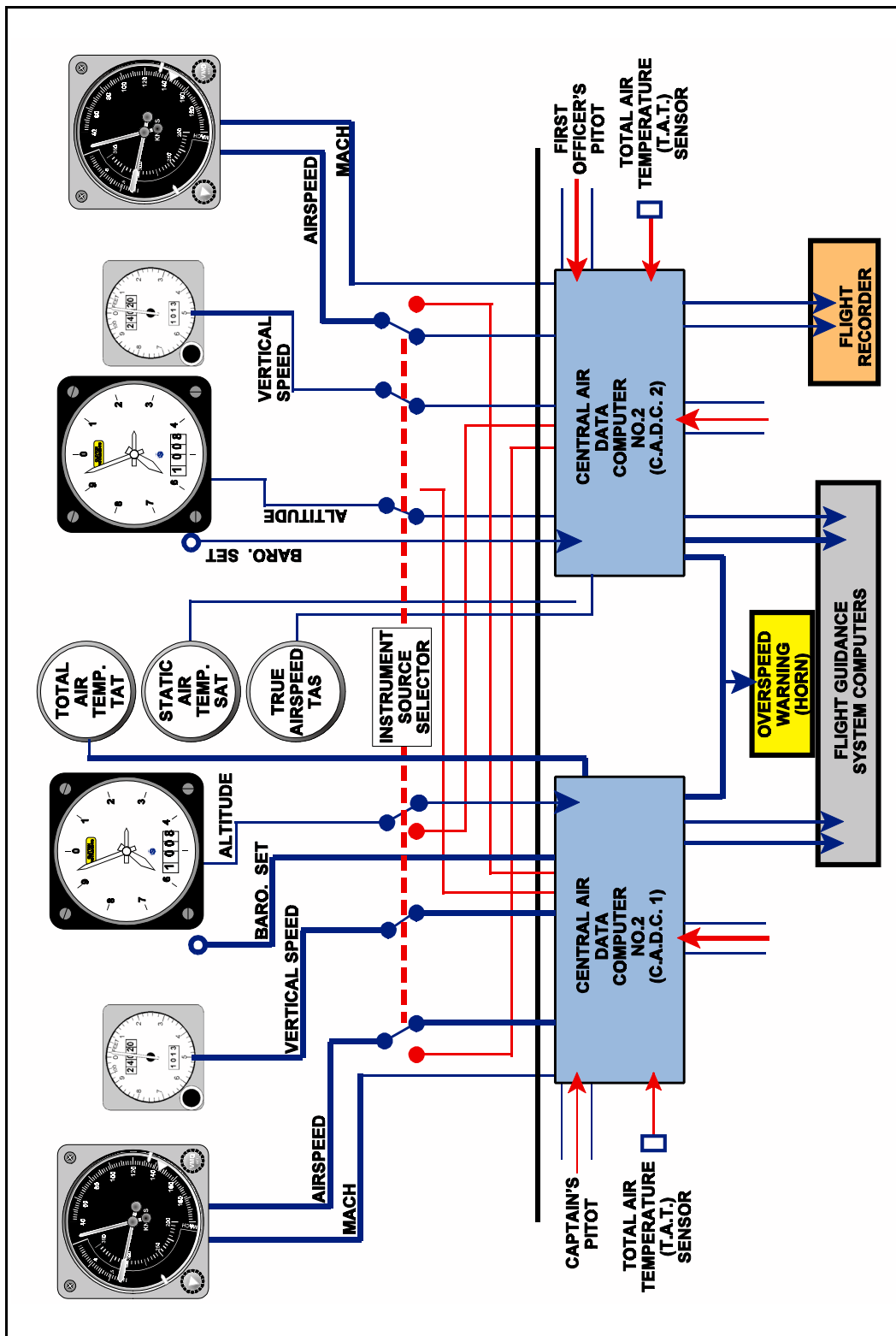

Figure 19.4 Combined Air Data System

CHAPTER TWENTY

RADIO ALTIMETER

Contents

INTRODUCTION267
FREQUENCIES.268
BASIC INDICATOR268
EFIS INDICATOR - BOEING STYLE.269
DIGITAL READOUT - BOEING STYLE270
EFIS INDICATOR - AIRBUS STYLE270
RANGE AND ACCURACY.271
AIRCRAFT INSTALLATION DELAY271

INTRODUCTION

The Radio Altimeter is a device capable of measuring the height of an aircraft above ground with a high degree of accuracy. Apart from providing a flight deck display of height Above Ground Level (AGL), the radio altimeter has two other important functions. It supplies the automatic flight system with data to affect automatic landings when used in association with the ILS / MLS.

The Radio Altimeter furnishes height information and rate of change of height, to the Ground Proximity Warning System (GPWS), and is a crucial component of this system

The instrument makes use of primary radio principles transmitting a Frequency Modulated Continuous Wave (FMCW) in an elliptical pattern vertically below the aircraft.

The Radio Altimeter determines the time taken for a radio wave to travel from the aircraft to the ground directly beneath the aircraft and back again. During this time the transmitted frequency changes at a known rate from its start level to +50MHz and back again to complete a "cycle".

The carrier frequency cannot be increased indefinitely and so after half a wavelength the change is reversed, the frequency then being decreased at a constant rate down to a specified value before being increased again. The complete "modulation cycle/frequency sweep" is illustrated in Fig 20.1.

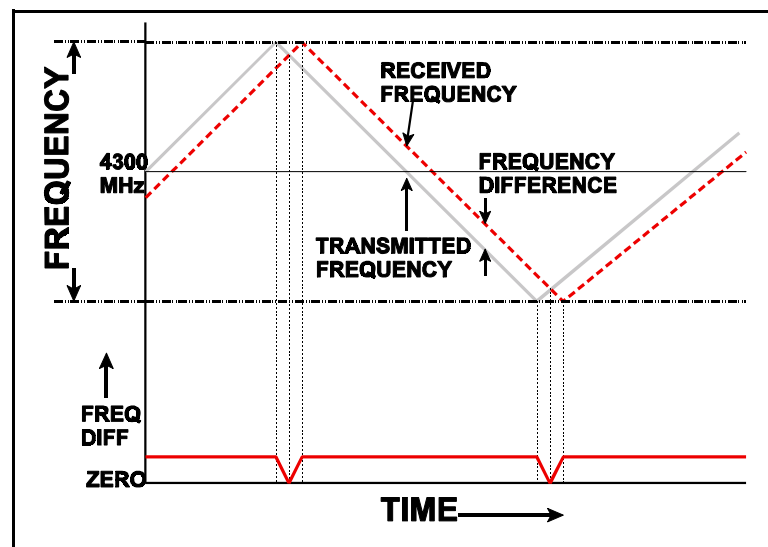

Figure 20.1

The equipment compares the frequencies of the transmitted and received signals and since the rate of frequency change is known, the frequency difference becomes a measure of the time taken for the radio wave to travel to and from the surface. From the information gained aircraft height may be determined.

The breakdown of frequency difference, which occurs when the transmitter changes the direction of its frequency sweep, is overcome by relating aircraft height to the average beat frequency (the difference between transmitted and received frequency) observed over a short sampling period. The frequency changeover points are thereby ignored.

FREQUENCIES

Two frequency bands have been used in the past, but only the SHF band is used at present:

4200 MHz to 4400 MHz - SHF band

1600 MHz to 1660 MHz - UHF band

The total sweep of the carrier frequency is automatically varied ± 50 MHz 300 times a second. At very low altitude with the reflection returning almost instantaneously, a wide sweep is necessary to give a measurable frequency difference. The signal is transmitted downwards from a flush mounted horn antenna. The conical / elliptical beam generated is wide enough to always allow some portion of the beam to travel vertically even with pitch angles of $\pm 30^\circ$ and roll angles of $\pm 60^\circ$. The height will be determined from the shortest path to the ground which, of course, will always be vertically below the aircraft.

Transmission being continuous, it is necessary to use a separate antenna, similar to the transmitting antenna for reception. The receiver antenna needs to be positioned far enough away to avoid interference with the transmitted signal.

Radiated power generated is of the order of One Watt.

BASIC INDICATOR

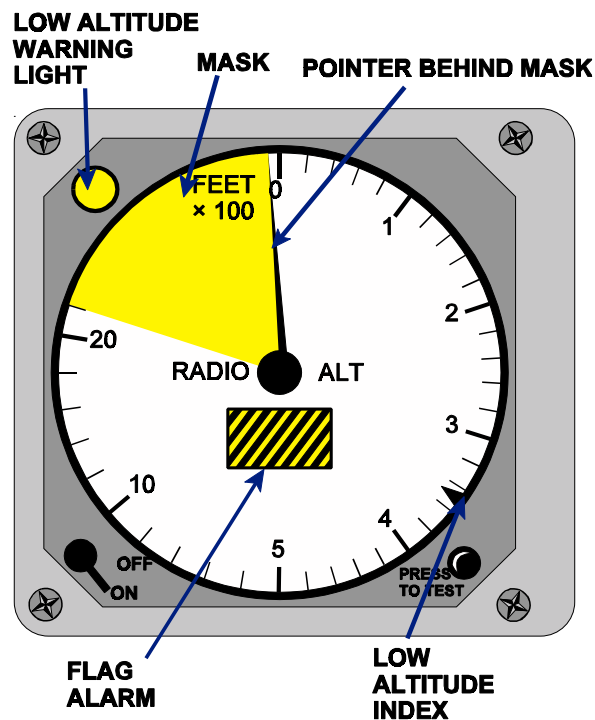

Figure 20.2

Height Scale

The scale is logarithmic being expanded from zero to 500 feet and at a reduced non-linear scale from 500 to 2500 feet.

Mask

The height pointer disappears behind a mask:

- when altitude exceeds 2500 feet
- when there is any fault in the transmitted signal
- when the altimeter is switched off

Failure Warning Flag

The flag appears when there is too much radio noise which will corrupt the returning signal, or if local reflections are received from the airframe itself, or in the event of a loss of power to the equipment.

Press to Test Button

When this button is pressed, the height pointer swings round to a known pre-set altitude. This provides a confidence check for the user indicating that the equipment is likely to operate satisfactorily.

Low Height Warning

The warning light illuminates if the aircraft is flown below any pre-selected height set by the pilot. The pilot sets his desired height on this instrument by means of the moveable index (DH) control knob on the face of the device. This occurrence is also audibly marked by the sudden cessation of an alert tone which will sound with increasing loudness from approximately 100 feet above the decision height setting

EFIS INDICATOR - BOEING STYLE

Figure 20.5

DIGITAL READOUT - BOEING STYLE

A digital read-out, and when below 1,000 feet a pictorial image of an altimeter dial, is drawn on some EFIS displays. The colour of this icon (which also shrinks in size below 1,000ft indicating height change) changes from white to flashing amber as decision height is approached. One further function of the radio altimeter is to desensitise the Auto-pilot and Flight Director response to the ILS glidepath in the latter stage of an approach.

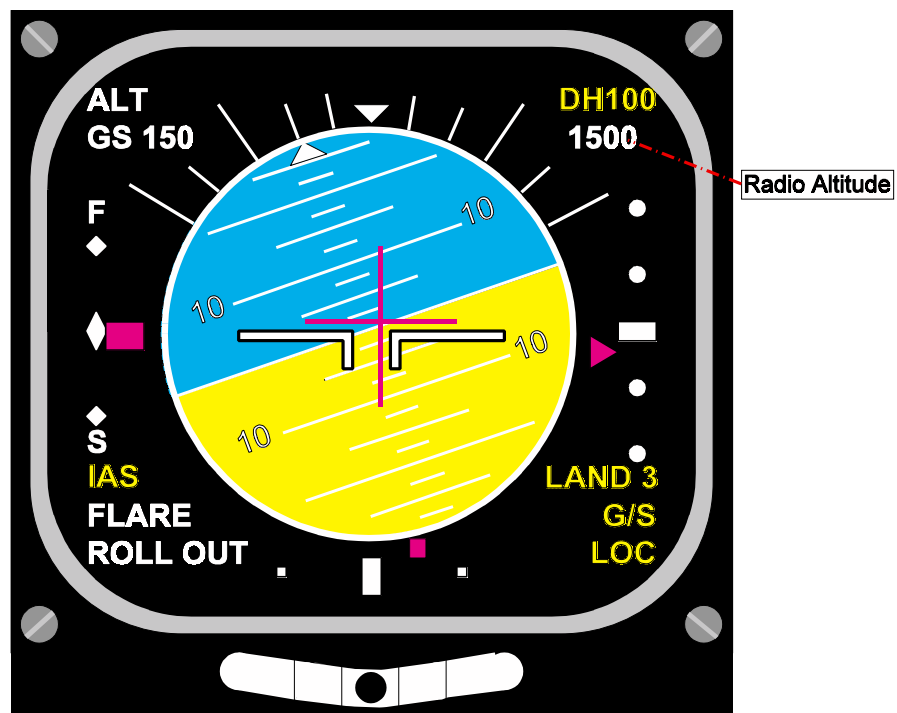
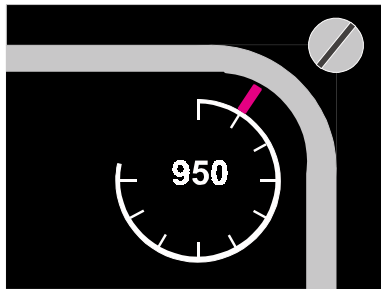

Figure 20.3

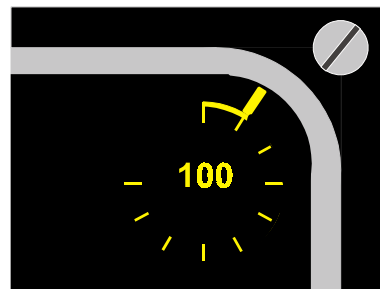
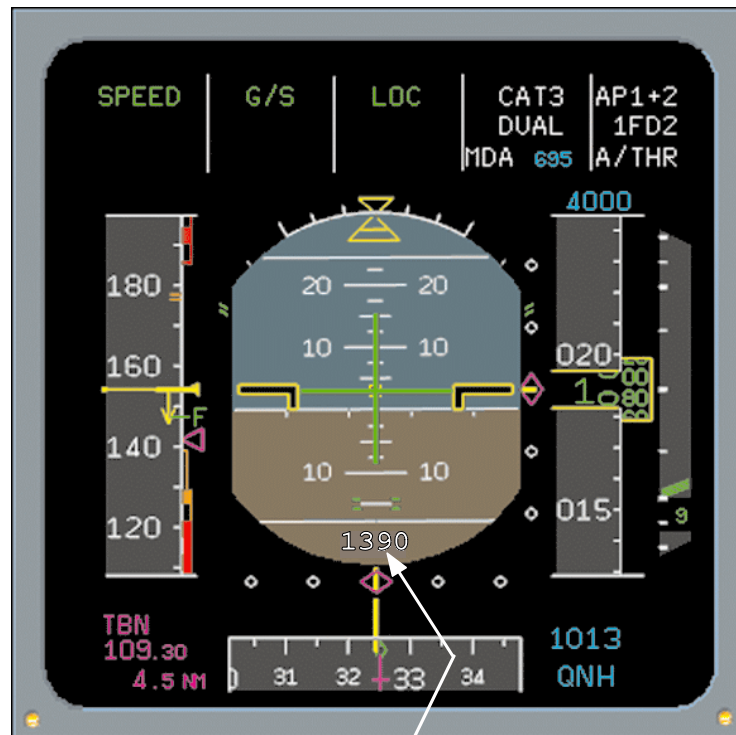

Figure 24.4

EFIS INDICATOR - AIRBUS STYLE



RADIO ALTIMETER - green above DH, amber below DH and bigger numbers

Figure 20.5a

On some more modern systems, such as that used by the A300, the indication of height is given at the base of the EADI / PFD attitude display. This height indication changes colour from Green to Amber and the numbers also grow in size as Decision Height is passed. It is also important to note that the Radio Altimeter is a major component of the Ground Proximity Warning System(GPWS).

RANGE AND ACCURACY

The instrument can be used between zero and 2500 feet above the surface with an overall expected accuracy of $\pm 3\%$ of indicated height or $\pm 1\text{ft}$ whichever is the greater. The figures include various error contributors, principally Doppler Shift, Step Error in the digital counting circuits, and Height Lag.

AIRCRAFT INSTALLATION DELAY

The Radio Altimeter is required to indicate zero height AGL as the main wheels touch down on the runway, because of this it has to be extremely accurate and in practice is designed to perform to an accuracy of \pm one foot. However, in practice a single manufacturer's product may be found in multiple aircraft types from the very large Boeing 747 to a much smaller corporate commuter jet and this must be catered for. At either extreme the aircraft weight and oleo compression will vary and this leads to the need for compensation to cater for this variable. The height difference between the antennae on the fuselage and the bottom of the trailing wheels on the main landing gear bogeys, on the approach to a touchdown, is known as the Residual Height. In addition, the different physical sizes of the aircraft concerned will create differences in cable run length between the Avionics Bay and the position of the antennae on the underside of the aircraft fuselage. When investigating the larger aircraft this distance may be as much as 100ft or, in the smaller jet, as little as 6ft. If compensation for cable length is not catered for in the larger aircraft an error would be generated and this would be seen as an error of height (perhaps to 100ft in the example above).

The Aircraft installation delay is therefore adjusted to compensate for Residual Height and Cable Length (times two - Tx Antennae/Rx Antennae to Avionics Bay) this is done to ensure that at touchdown with the main bogeys trailing the Rad' Alt' reads zero.

Additionally, it should be noted that when on the ground, the radio altimeter may show a small negative altitude. The reason for this is that the equipment has been adjusted to indicate zero when the main wheels first touch the runway surface on landing and therefore when the aircraft is level on the ground the antenna will be below its calibrated position relative to the aircraft landing attitude. The effect is particularly noticeable with aircraft such as the B747 (which actually indicates -8ft) which have multi-wheel assemblies which are inclined at an upward angle when deployed in flight and thereby create a larger difference between antenna position and wheels at the point of touchdown.

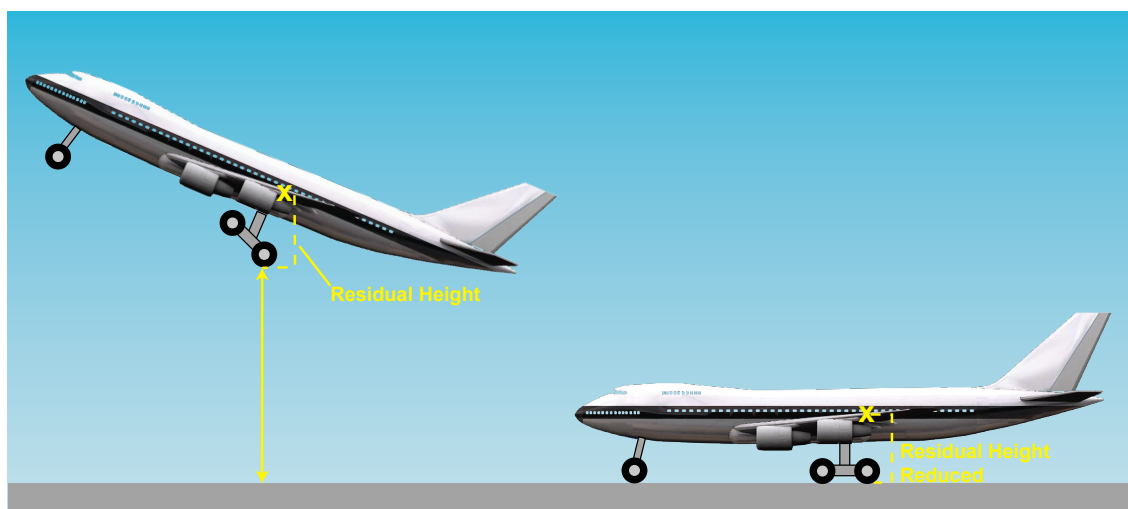

Figure 20.6 Undercarriage Residual Height

CHAPTER TWENTY ONE
FLIGHT MANAGEMENT SYSTEM

Contents

PRINCIPLE OF OPERATION.275

CONTROL AND DISPLAY UNIT (CDU)275

DATA BASE.276

OPERATIONAL PROCEDURES - INITIAL ACTIONS277

SUMMARY278

OPERATIONAL PROCEDURES - CLIMB VERTICAL NAVIGATION (VNAV)278

 - CRUISE LATERAL NAVIGATION (LNAV)279

 - DESCENT279

 - ACCURACY279

 - CONTROL AND DISPLAY UNIT280

PRINCIPLE OF OPERATION

Flight management systems are designed to improve navigation, aid fuel efficiency and to reduce crew workload. Computers are used to fly aircraft along complex routes using Lateral Guidance (LNAV).

Vertical Guidance (VNAV) enables the system to calculate optimum cruise altitudes and to determine the best combination of auto-throttle control and speed during climb and descent.

At all times when the crew are not actually controlling the aircraft by hand, they use the FMS controls to “fly” the aircraft. The controls of a FMS are, in effect, a miniature flight deck with fingertip control.

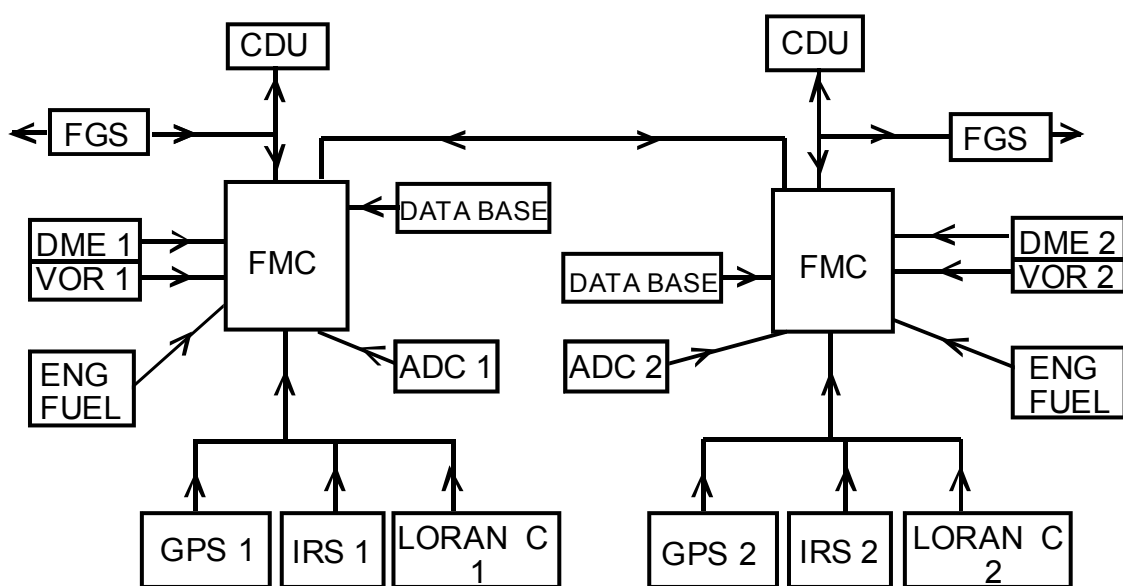

Figure 21.1 Schematic layout of a typical system

Legend:

- CDU - Control and Display Unit
- FGS - Flight Guidance System
- FMC - Flight Management Computer
- ADC - Air Data Computer
- IRS - Inertial Reference System
- GPS - Global Positioning System

CONTROL AND DISPLAY UNIT (CDU)

The primary function of the CDU is to act as the interface between the aircraft and the crew. The CDU can be used to command completely automatic control of the aircraft or semi-automatic with varying degrees of pilot involvement including full manual control.

Two CDUs are usually fitted either side of the centre console with the left CDU normally being the master (in the B747-400 they are joined by a third CDU placed upon the centre console for use primarily by engineering staff). They comprise of a monochrome or coloured cathode ray tube (CRT) display on which different “pages” of selected data can be shown, and a selector key panel.

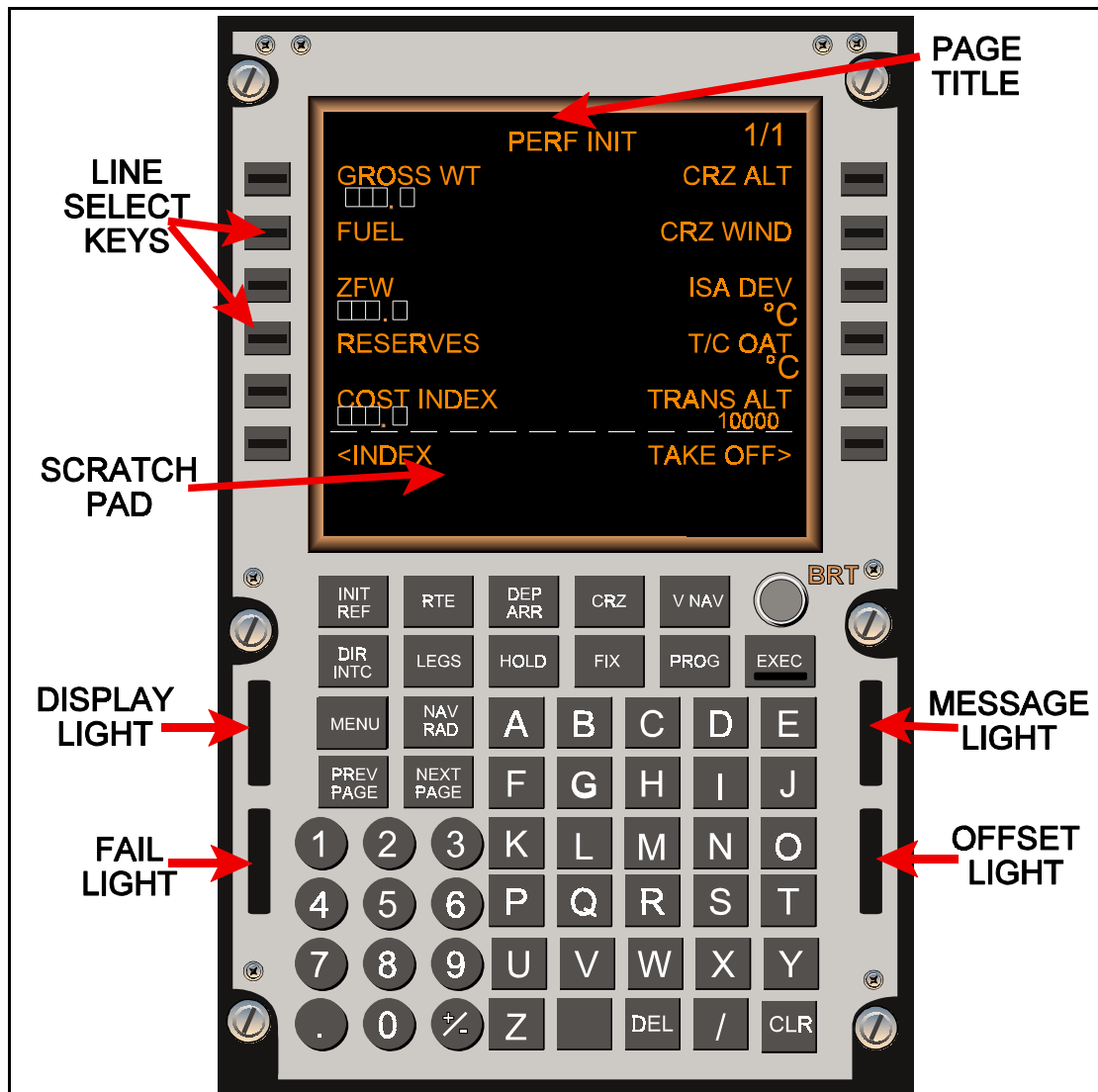

Figure 21.2

The FMCs may be decoupled to provide fully **Independent Mode** operation. This is not usual in that there will be no safety/cross check between the two FMCs.

When operating in **Dual Mode** (the norm for ordinary flight profiles) both FMCs independently process pilot entries on both MCDUs and **compare** the results to ensure that crucial information is consistent on both systems. The same output is then passed to both FMCs.

If there is a failure of an FMC the second system can be expected to operate the aircraft successfully on its own - this is known as **Single Mode**. The failed FMC may be selected out of the system to allow single mode operation of the "surviving" FMC if required by the crew.

DATA BASE

The information stored in the FMC is called its data base. The data base is divided into two major sections. One contains **performance** related information and the other contains information dealing with **navigation**.

The purpose of the performance data base is to reduce the need for the flight crew to refer to the Cruise Control Manual during flight and to provide the FMC with information required to calculate pitch and thrust commands. All reference data normally required can be displayed on the FMS-CDU. The data stored in the data base includes aircraft drag and engine characteristics, maximum and minimum speeds. Maintenance can refine the data base for each aircraft by entering factors for drag and fuel flow.

The FMC navigation data base includes most information that would normally be determined by referring to navigation charts. This information may be displayed on the FMS-CDU / AMD and eliminates most of the cockpit chart reading in aircraft without an FMC. The geographic area covered includes all areas where the aircraft is normally flown. The stored information includes the location of navigation aids, airports, runways and other airline selected information such as SIDs, STARs, approaches and company routes.

The FMC contains two sets of navigation data, each valid for 28 days. Each set corresponds to the normal revision cycle for navigation charts. During preflight the flight crew can select which set is active. The FMC uses the active set for navigation calculations. The contents of the navigation data base are **updated by maintenance** every 28 days. When the navigation chart revision date arrives, the new data is already in the FMC and ready for selection.

OPERATIONAL PROCEDURES - INITIAL ACTIONS

IDENT Page: Upon application of power to the aircraft the FMS immediately executes a self- test procedure and upon its successful self completion the IDENT page of the system is displayed. The IDENT page of the FMC allows the crew to confirm aircraft details on start-up and this in turn initiates a series of prompts to direct the crew through the route procedures that need to be generated for their flight. Importantly on this page we have confirmation of the Navigation Data Base in operation and an indication of the date of changeover to the next programme - if the data base is out of date it will tell us to change to the in date programme.

POS INIT Page: When we have checked the IDENT page we will be directed to the POS INIT page where we must check the FMS clock time against the aircraft clock to ensure synchronisation between the systems: data is saved on the FDR against time and of course ETAs are generated by the FMC and need to be in line with times indicated by the aircraft clock. As we complete this task we must also ensure that the airfield datum or gate position, if available, is entered accurately to allow for IRS alignment (this position will be suitable for alignment but is often updated at the take-off point to obtain the best possible initial position for use in flight).

RTE Page: After completing our tasks upon the POS INIT page we will be directed to the RTE page where we will enter our starting and destination airport ICAO Designators. We may then expect to enter our flight number details and identify a "standard" company route to take us to our destination: if a standard route is not available other actions will have to be taken to input the information into the system.

PERF INIT Page: We may now move on to the PERF INIT page to update the aircraft to its current performance / weight configuration for the route to be flown. On this page we may input details of fuel weight, fuel reserves required, cruise altitude and even, in the case of the B747, if we are carrying a fifth engine to our destination upon its suspension point on the wing. At this stage we may also enter Cost Index requirements related to our flight as discussed later in the chapter.

SUMMARY

The following is a summary of the initial pages that you may expect to see on the Boeing series of aircraft currently in use but of course this information may vary from company to company as they modify the system for their own use:

IDENT page -

- Aeroplane Model / Configuration
- Operational Programme Identifier
- Drag / Fuel Flow Factors
- Navigation Data Base identifier / cycle

POS INIT page -

- IRS Position Reference
- IRS Heading Reference
- GMT / UTC / Time Zone Display

RTE page -

- Origin Airport
- Destination Airport
- Flight Number

Route Activation

PERF INIT page -

- Gross Weight
- Fuel Quantity
- Zero Fuel Weight
- Fuel reserves
- Cost Index
- Cruise altitude
- Spare (fifth) engine carriage (B747 specific)
- Altitude Step Size

OPERATIONAL PROCEDURES - CLIMB VERTICAL NAVIGATION (VNAV)

Entering a cost index of "ZERO" provides economy speeds representing a maximum range cruise. The VNAV profile that the FMC commands is a climb with climb thrust to remain within all airspeed and altitude constraints that are part of the SID entered into the active route, then climb at economy speed to the entered cruise altitude.

If when flying the climb speed profile it would cause a violation of an altitude constraint the UNABLE NEXT ALT message is displayed. The pilot must then select a different speed on the FMS-CDU that provides a steeper climb angle. Reaching cruise altitude, the FMC commands cruise at economy speed until the top of descent point.

A number of Cost index modifications are allowed until passing Top of Descent point (TOD) for example Long Range Cruise (LRC) and "selected speed" cruise may also be entered.

Notes: *Time Related Cost is a function of speed selected, the higher the speed in climb, cruise or descent the higher the "trip fuel cost" but the lower the "trip time cost".*

Economy Cruise Mode will yield the lowest operating cost based on the cost index.

Cost Index is determined by dividing aeroplane operating cost (\$ / £ per hour) by fuel cost (\$ / £ per pound or litre). A cost index of Zero results in "minimum trip fuel operation" and so will include cruise at "maximum range" cruise and a low speed descent.

OPERATIONAL PROCEDURES - CRUISE LATERAL NAVIGATION (LNAV)

LNAV guidance outputs from the FMC are normally great circle tracks between the waypoints making up the active route. However, when a procedure stored in the FMS data base is entered into the active route the FMC can supply commands to fly a constant heading, track or follow a DME arc, as required to comply with the procedure.

FMC determines present position by using inputs from the IRS / INS, DME, VOR and other navigation systems fitted. It uses its calculated present position to generate lateral steering commands along the active leg to the active waypoint. To function, the FMC requires position information from at least one IRS / INS. While the aircraft is on the ground, the FMC calculates present position based only on information received from the IRS / INSs.

The FMC present position is normally the combination of all IRS / INS positions and since inertial systems accumulate position errors as a function of time, the position information being used by the FMC is slowly accumulating errors. These position errors can be detected by observing the various positions of the individual IRS / INS s on the CDU. If an extended ground delay occurs and a significant map error is noticed, the IRS / INS should be realigned and present position re-entered.

OPERATIONAL PROCEDURES - DESCENT

When a programmed "arrival" is entered, the FMC calculates a descent path based on the procedure's airspeed and altitude constraints and the End of Descent (E/D). The E/D is a waypoint with an altitude and airspeed constraint that coincides with a final approach fix or runway threshold.

For VFR and non-precision approaches, the FMC computed path is built to a point that is 50 feet over the approach end of the runway. It is the flight crews' responsibility to not descend below "DH" until adequate visual contact has been achieved. During a missed approach, LNAV guidance is available to the missed approach point and altitude.

OPERATIONAL PROCEDURES - ACCURACY

Radial error rates of less than 0.05 nm/hour are not uncommon. Introduction of Ground Positioning by Satellite(GPS) as a navigation input will improve overall performance. It must be stressed however that the skill of the operator and the need for constant and careful monitoring will always be a deciding factor.

OPERATIONAL PROCEDURES - CONTROL AND DISPLAY UNIT

CDU Key Groups. The keys on the lighted switch panel of the CDU perform various functions and may be broken down into three major groups:

- Alphanumeric
- Function and Mode
- Line Select Keys (LSK)

The function of each of the keys is briefly described below:

Alphanumeric Keys -Pressing any alphanumeric key results in that character appearing in the scratch pad.

Function and Mode Keys -Used for initialising the system, access to flight planning functions and status, and modifying the flight plan. Select climb, cruise or descent information for preplanning or modification.

CLB	CLB (climb) - displays current or alternate climb mode for assessment and selection. Cruise altitude is enterable, as is a speed / altitude restriction.
CRZ	CRZ (cruise) - displays current or alternate cruise mode for assessment and selection. Information about optimum altitude, step-climb savings, and turbulence penetration N1 targets is also available.
DES	DES (descent) - displays current or alternate descent mode for assessment and selection. Target speed is enterable, as is a speed / altitude restriction. Flight Path Angle(FPA), Vertical Speed(V/S), and Vertical Bearing(V/B). Information is provided for crew reference.
INIT REF	INIT/REF (initialisation / reference) - allows access to data pages required for start-up of the FMCS and IRS. Also, the operator may select various reference data and maintenance pages.
N1 LIMIT	N1 Limit - permits manual command of the active N1 limit, and selection of any Reduced Climb N1 Limit that may apply. (Allows the crew to select an engine, "LP Turbine", RPM.)
MENU	The N1 Limit key may be shown as a menu key on the master (left hand) CDU and can be used to find data within the system.
DEP ARR	DEP/ARR (departures / arrivals) - used for selection of the procedures and runways at the origin and destination airports.

RTE	RTE (route) - permits flight plan data entries. A primary means for lateral flight plan alteration.
LEGS	LEGS (route legs) - displays and accepts entries of detailed data concerning each leg of the flight plan, for both the lateral and vertical paths.
HOLD	HOLD - permits planning or initiation of holding at a designated waypoint.
DIR INTC	DIR/INTC (direct / intercept) - provides data capability to proceed direct to any point desired, or to intercept any leg presently in the flight plan.
FIX	FIX (fix information) - displays range and bearing data from the present position to an entered fix. Facilitates creation of fixes for use in flight planning.
PROG	PROG (flight progress) - displays current flight status information such as ETA, fuel remaining at waypoint, navigation radio tuning status, wind, and path errors.
====	Line Select Keys (LSK) - entry of data from the scratch pad into the selected line and field is accomplished by using the LSKs. There are twelve LSKs on the CDU panel, six each to the left and right of the CRT display. Data entries are permitted only on lines adjacent to the LSKs. Data can also be duplicated into the blank scratch pad by pressing the LSK adjacent to the desired data line.
EXEC	EXEC (execute) - used to incorporate data displayed on the CDU as part of the active flight plan. The EXEC key is operable when its annunciator bar is illuminated. The key is used for activating the flight plan, changing the active flight plan, changing the active guidance mode, or inserting data which will affect the active flight plan, guidance mode, or data base. Illumination of the white annunciator bar indicates that a valid set of data is on display and may be made active for guidance of the aircraft.
+ / -	Change Sign Key - changes data in the scratch pad from positive to negative and back again. May also be used to insert a hyphen for specialised data entries.
PREV PAGE	Page Select Keys - when multiple-page displays are shown, pressing the NEXT PAGE key advances the display to the next higher page number. Pressing PREV PAGE backs up the display to the next lower page number. Page access wraps around.
NEXT PAGE	
CLR	Clear Key - the scratch pad's contents can be edited or cleared by pressing the CLR key. When an entry is present in the scratch pad, a brief depression of the CLR key will clear the last character in the entry. If the CLR key is held down for more than one second, the entire entry in the scratch pad will be cleared. The CLR key is also used to clear advisory and alerting messages from the scratch pad.

DEL

Delete Key - the delete (DEL) key is used to remove data from a display (and thus a flight plan) after it has been line selected and accepted into a data field. If the scratch pad is empty, depression of the DEL key writes ("DELETE") into the scratch pad. The delete process is then completed by line-selecting (LSK) the data item to be removed. If the deletion is a valid one, the data field reverts to its default value (box prompts, dashes, or a system-generated value). The system prevents invalid use of the DEL key.

Illuminated Annunciators

There are four annunciators on the front of the CDU as shown in the illustration:

MSG	Illuminates white in colour; indicates an alerting or advisory message or pending messages.
FAIL	Illuminates amber in colour; lit if FMC failure is detected.
DISPLAY	Illuminates white in colour if the page displayed is not related to the active flight plan leg or to the current operational performance mode.
OFFSET	Illuminates white in colour when a parallel offset is in use (ie. the aeroplane is flying parallel to, but a fixed distance from, the FMS preprogrammed track).

CHAPTER TWENTY TWO

ELECTRONIC FLIGHT INFORMATION SYSTEM (EFIS)

Contents

THE ELECTRONIC FLIGHT INSTRUMENT SYSTEM (EFIS)285
THE UNITS OF A SYSTEM285
SYMBOL GENERATORS (SGs).285
DISPLAY UNITS286
THE COLOUR DISPLAY SYSTEM.286
THE REMOTE LIGHT SENSOR287
THE CONTROL PANEL287
THE 'EADI' SECTION OF THE CONTROL PANEL.288
DECISION HEIGHT (DH)288
THE 'EADI' DISPLAY PRESENTATION288
THE 'EHSI' SECTION OF THE CONTROL PANEL290
SYSTEM SYMBOLS291
THE 'EHSI' DISPLAY PRESENTATION.292
FULL VOR MODE293
EXPANDED VOR294
FULL ILS MODE.295
EXPANDED ILS296
MAP MODE297
PLAN MODE.298
DATA SOURCE SELECTION.298
FAILURE ANNUNCIATION299
NAVIGATION DISPLAYS.299
EXAMPLE DISPLAYS303
QUESTIONS304
ANNEX A.307
ANSWERS308

THE ELECTRONIC FLIGHT INSTRUMENT SYSTEM (EFIS)

The Electronic Flight Instrument System presents attitude and navigation information to the pilot on two electronic display units in a format that is easier to read and less likely to be misinterpreted than some older mechanical instruments.

As far as the pure basic functions and number of display units are concerned, this system, (which is generally referred to as 'EFIS'), is fully integrated with digital computer-based navigation systems, and utilises colour Cathode Ray Tube (CRT) or Liquid Crystal Display (LCD) types of **Attitude Director Indicator (ADI)** and **Horizontal Situation Indicator (HSI)**.

The system is therefore extremely advanced, not only in terms of physical construction, but also in the extent to which it can present attitude and navigational data to the flight crew of an aircraft.

THE UNITS OF A SYSTEM

As in the case of a multi crew conventional flight director system, a complete EFIS installation is made up of left (Captain), and right (First Officer), systems.

Each system in turn is comprised of:

- Electronic Attitude Director Indicator (EADI) or Primary Flight Display (PFD)
- Electronic Horizontal Situation Indicator (EHSI) or Navigation Display (ND)
- Control Panel
- Symbol Generator (SG)
- Remote Light Sensor Unit

A third (centre) Symbol Generator is also incorporated so that its drive signals may be switched to either the left or right display units in the event of failure of their corresponding Symbol Generators.

The signal switching is accomplished within the left and right Symbol Generators, using electromechanical relays powered from an aircraft's DC power supply, via pilot-controlled switches.

The interface between EFIS units, data busses and other systems is shown in Figure 22.1

SYMBOL GENERATORS (SGs)

Symbol Generators provide the analogue, discrete, and digital signal interfaces between an aircraft's systems, the display units, and the control panel, and they also perform symbol generation monitoring, power control and the main control functions of the 'EFIS' overall.

The interfacing between the card modules of an SG is shown in Figure 22.1.

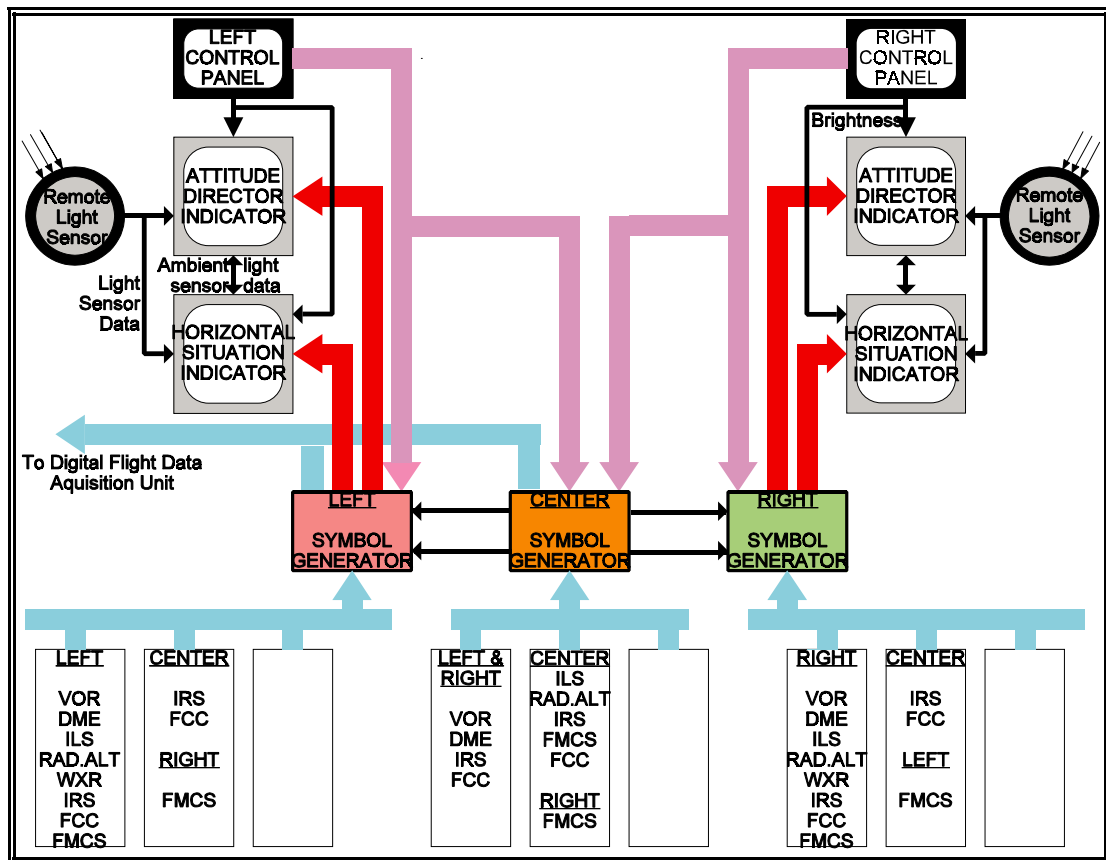

Figure 22.1 Multi-Crew EFIS Units and Signal Interfacing

DISPLAY UNITS

The display units may be Cathode Ray Tubes (CRT's) or Liquid Crystal Displays (LCD's). LCD's have the advantage of being smaller and generate less heat therefore need less cooling. The PFD and ND are usually identical units to facilitate spares commonality and are often interchangeable with the systems display units (EICAS or ECAM).

THE COLOUR DISPLAY SYSTEM

There is no set colour standard and so colour displays may vary slightly.

In a typical display system, 5 colours are usually assigned for the display of the many symbols, failure annunciators, messages and other alphanumeric information, with a sixth colour (RED) for weather (WXR):

- WHITE** Display of present situation information.
- GREEN** Display of present situation information where contrast with white symbols is required, or for data having lower priority than white symbols. Engaged autoflight modes
- MAGENTA** All 'fly to' information such as flight director commands, deviation pointers, active flight path lines.

- CYAN** Sky shading on an EADI and for low-priority information such as non active flight plan map data.
- YELLOW** Ground shading on an EADI, caution information display such as failure warning flags, limit and alert annunciators and fault messages.
- RED** For display of heaviest precipitation levels as detected by the weather radar (WXR).

THE REMOTE LIGHT SENSOR

The Remote Light Sensor is a photodiode device which responds to ambient light conditions on the flight deck, and automatically adjusts the brightness of the CRT displays to an acceptable level.

THE CONTROL PANEL

A control panel is provided for each system, and are typically, as shown in Figure 22.2, the switches are grouped for the purpose of controlling the displays of their respective **EADI** and **EHSI** units.

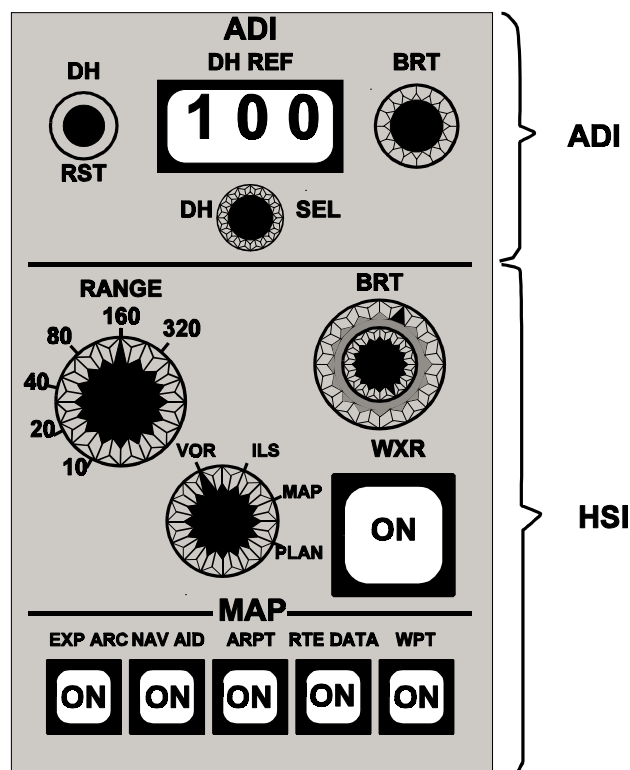

Figure 22.2 An EFIS Control Panel

THE 'EADI' SECTION OF THE CONTROL PANEL

Brightness Control(BRT).	Used to adjust the brightness of the ADI display to the desired level.
Decision Height Selector(DH SEL).	Used to select desired decision height for DH alerting.
Decision Height Reset Switch(DH RST).	When pressed it resets a DH alert on the associated ADI . It changes the RA display from yellow to white.
Decision Height Reference Indicator(DH REF).	This displays the selected decision height on the controller, and on the EADI .

DECISION HEIGHT (DH)

Decision height is the wheel height above the runway elevation by which a go-around must be initiated unless adequate visual reference has been established and the aircraft position and approach path have been assessed as satisfactory to continue the approach and landing in safety.

THE 'EADI' DISPLAY PRESENTATION

The 'EADI' (Figure 22.3) displays normal pitch and roll attitude indications plus

- Attitude data from an Inertial Reference System (**IRS**)
- Flight director commands
- Localizer and glide slope deviation
- Ground speed
- Radio Altitude
- Decision height
- Automatic Flight Control System (**AFCS**) and Auto-throttle modes
- Speed error scale (Difference between commanded and actual)

Note: The autoland status, pitch, roll-armed and engage modes are selected on the **AFCS** control panel.

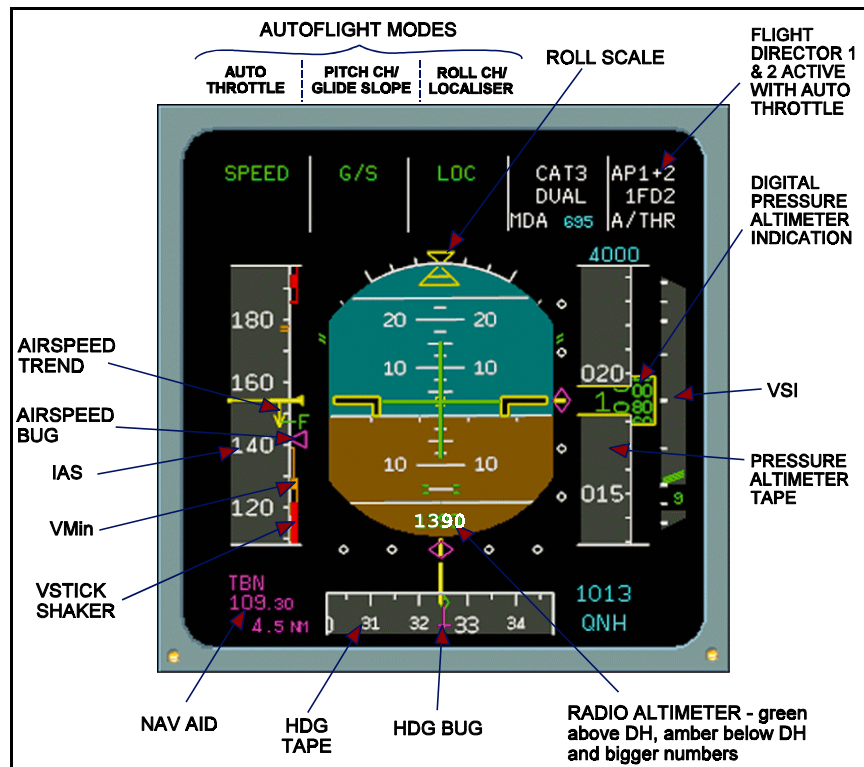

Figure 22.3 An A300 PFD

Decision height (DH) is selected on the ADI control panel and shown on both the ADI and on the control panel.

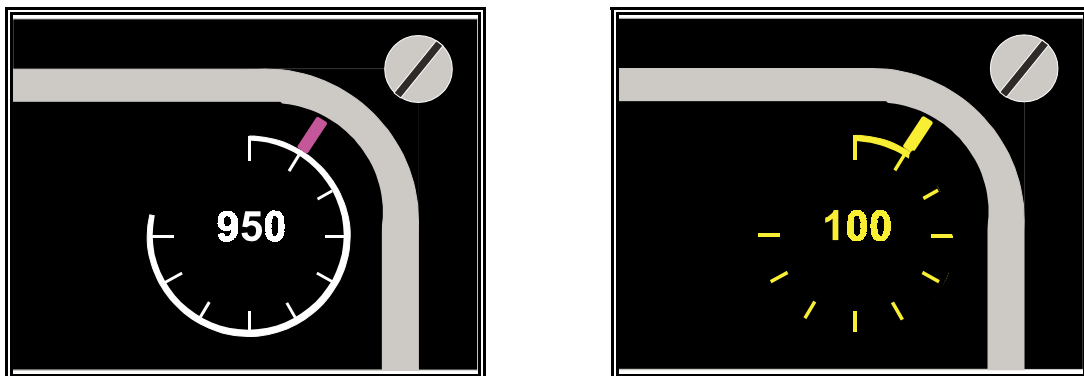

Figure 22.4. Decision Height and Radio Altimeter Presentation Below 1,000 Feet.

At Decision Height

Radio altitude on some systems is digitally displayed during when the aircraft is between 2,500ft and 1,000 ft above ground level.

Below 1,000 ft the display automatically changes to a white circular scale calibrated in increments of 100 ft, and the selected decision height is then displayed as a magenta-coloured marker on the outer scale. The radio altitude also appears within the scale as a digital readout. As the aircraft descends, segments of the altitude scale are simultaneously erased so that the scale continuously diminishes in length in an anti-clockwise direction.

On the descent, at decision height plus about 50 ft, an **aural alert chime** sounds at an increasing rate until decision height is reached.

On reaching **DH** the marker and scale flash and change from magenta to amber or yellow. Pressing the **EADI** control panel **DH RST** button will cancel the alert chime, stop the marker flashing and change the **DH** displays back to their normal colour.

Deviation beyond normal Localiser and Glide slope limits cause the scales to change colour to amber and the pointer to flash, which ceases if the aircraft returns to within limits.

Note: The **A300** system currently in use differs from the above by using digital readout only. This system, which is also found on some other aircraft types, displays Rad Alt at the base of the PFD centre display using Green numbers above Decision Height and Amber, slightly bigger numbers below. The digital readout is enhanced by a voice warning system which will give aural indications of height passing to the pilot. The aural warnings will be given at significant heights as decided by the manufacturer working with the airline company at time of system build.

The **Speed Error Display** consists of a pointer which moves relative to a deviation scale to show difference between actual speed and commanded speed.

THE 'EHSI' SECTION OF THE CONTROL PANEL

RANGE	Selects range for displayed navigation data and WXR .
MODE SELECTOR	Selects display appropriate to mode required: VOR , ILS , MAP , PLAN .
BRT (BRIGHTNESS)	Outer knob sets main display brightness. Inner knob sets WXR display brightness.
MAP switches	Used in MAP mode. When selected, they cause their placarded data to be displayed on the EHSI :- NAV AID (NAVIGATION AID), ARPT (AIRPORT), RTE DATA (ROUTE DATA), WPT (WAYPOINTS).
EXP ARC	Selects VOR or ILS mode to show an Expanded Arc
WXR	When pushed in, WXR data is displayed during all modes except PLAN , or when the VOR / ILS mode is selected to present the FULL compass rose.

SYSTEM SYMBOLS



Active Waypoint (Magenta)
the waypoint the aircraft is
currently navigating to.



Inactive Waypoint (White)
a navigation point making up
the selected active route.



Airports (Cyan).



Off Route Waypoint (Cyan)



Tuned Navaid (Green).



Unused Navaid (Cyan)



Wind Direction (White) with respect to
map display orientation and compass
reference. Symbol shown in white against the
black of the screen.

THE 'EHSI' DISPLAY PRESENTATION

The EHSI presents a selectable, dynamic colour display of flight progress and a plan view orientation. Four principal display modes may be selected on the EFIS control panel:-

- VOR
- ILS
- MAP
- PLAN

Of these VOR and ILS can be displayed as full or expanded compass displays.



Figure 22.5 PFD and ND as fitted to the A300 series of aircraft.

The orientation of the displays may be **Magnetic** or **True**, **Track** or **Heading** as selected.

FULL VOR MODE



With a VOR frequency selected, the EHSI displays a full compass rose with the VOR source in the lower left and the frequency in the lower right.

Course selection is displayed by the magenta course needle the tip pointing to the selected course (150). Course deviation is shown by the traditional deviation bar moving across a two dot left and two dot right scale.

A TO / FROM Pointer is shown in addition to the TO /FROM annunciation.

DME distance displayed in the top left corner

Current heading is shown in the window and by the lubber line at the top of the compass rose (130), the current selection is Magnetic Heading as shown either side of the window

Current track is shown by the white triangle on the inside edge of the compass rose.

Selected heading shown by the magenta heading "bug" on the outer scale of the compass rose

Wind speed and direction are shown in the lower left corner orientated to the display selection (Heading or Track, Magnetic or True)

Weather Radar displays are not available.

EXPANDED VOR

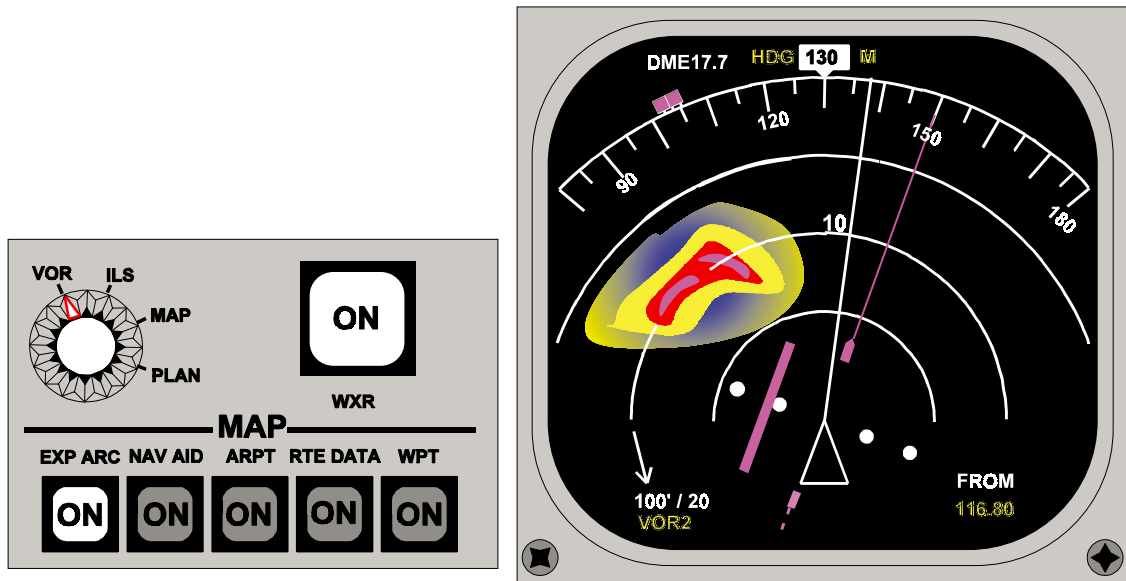

With a VOR frequency selected, the EHSI displays about 90° of compass rose with the VOR source in the lower left and the frequency in the lower right.

The white triangle at the bottom of the display is the aircraft symbol

Selected course (track) is displayed by the magenta course needle the tip pointing to the selected course (150). The course selectors are usually on either side of the autoflight main control panel

(one for the Captain and one for the First Officer). Course deviation is shown by the traditional deviation bar moving across a two dot left and two dot right scale.

A TO /FROM annunciation is shown.

DME distance displayed in the top left corner

Current heading is shown in the window and by the lubber line at the top of the compass rose (130), the current selection is Magnetic Heading as shown either side of the track window. Current track is shown by the white line from the tip of the aircraft symbol to the compass arc. Selected heading shown by the magenta heading "bug" on the outer scale of the compass rose. Wind speed and direction are shown in the lower left corner orientated to the display selection (Heading or Track, Magnetic or True).

Weather Radar displays are available, when selected "on" range arcs are also visible. Weather Radar shows three colours green, yellow and red, green being the least turbulence, red being the worst. If turbulence mode is available it is shown as magenta, the area of greatest activity in the cloud. The range of the display can be selected on the control panel, half scale range is displayed (10 Nm) so this display is selected to 20 Nm. The outer arc of the compass rose is the furthest range from the aircraft.

FULL ILS MODE



With an ILS frequency selected, the EHSI displays a full compass rose with the ILS source in the lower left and the frequency in the lower right.

Course selection (Localiser) is displayed by the magenta course needle the tip pointing to the selected course (150). Localiser deviation is shown by the traditional deviation bar moving across a two dot left and two dot right scale.

Glide slope deviation shown by a magenta coloured triangle moving up and down the traditional scale on the right hand side.

DME distance displayed in the top left corner

Current heading is shown in the window and by the lubber line at the top of the compass rose (130), the current selection is Magnetic Heading as shown either side of the window

Current track is shown by the white triangle on the inside edge of the compass rose.

Selected heading shown by the magenta heading “bug” on the outer scale of the compass rose

Wind speed and direction are shown in the lower left corner orientated to the display selection (Heading or Track, Magnetic or True).

Weather Radar displays are not available.

EXPANDED ILS

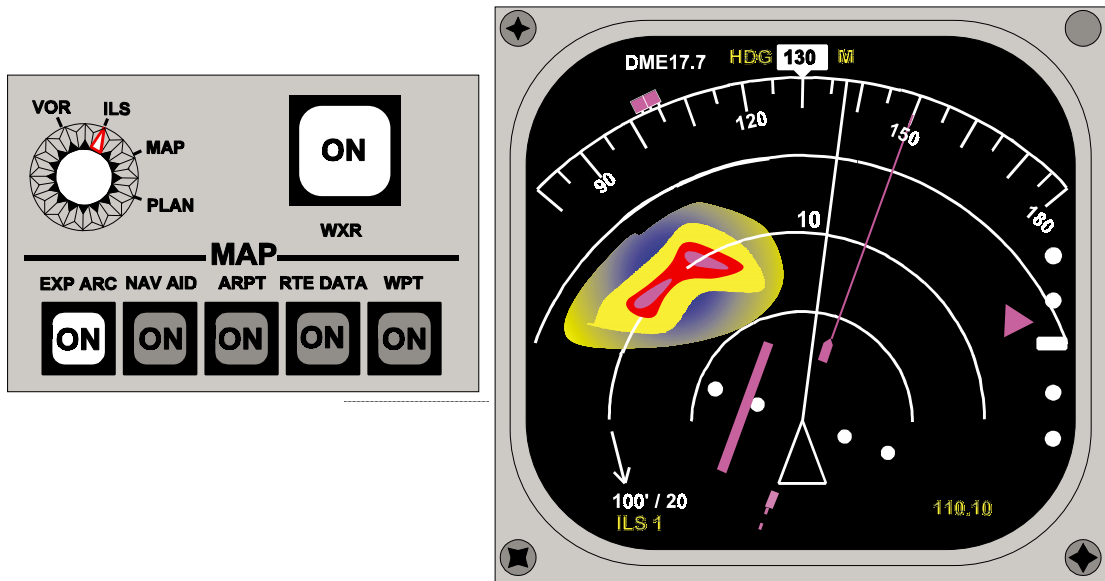

With an ILS frequency selected, the EHSDI displays about 90° of compass rose with the ILS source in the lower left and the frequency in the lower right.

The white triangle at the bottom of the display is the aircraft symbol.

Selected course (track) is displayed by the magenta course needle the tip pointing to the selected course (150). The course selectors are usually on either side of the autoflight main control panel (one for the Captain and one for the First Officer). Localiser deviation is shown by the traditional deviation bar moving across a two dot left and two dot right scale. Glide slope deviation shown on the right again in the traditional fashion.

DME distance displayed in the top left corner.

Current heading is shown in the window and by the lubber line at the top of the compass rose. In this case is the heading is 1300 Magnetic, as indicated by markings either side of the window. Current track is shown by the white line from the tip of the aircraft symbol to the inside edge of the compass rose.

Selected heading shown by the magenta heading "bug" on the outer scale of the compass rose. Wind speed and direction are shown in the lower left corner orientated to the display selection (Heading or Track, Magnetic or True).

Weather Radar displays are available, when selected "on" range arcs are also visible. Weather Radar is shown in three colours green, yellow and red, green being the least turbulence, red being the worst. If **TURBULENCE MODE** is available it is shown as magenta, the area of greatest activity in the cloud.

The range of the display can be selected on the control panel, half scale range is displayed (10 nm) so this display is selected to 20 nm. The outer arc of the compass rose is the furthest range from the aircraft.

MAP MODE

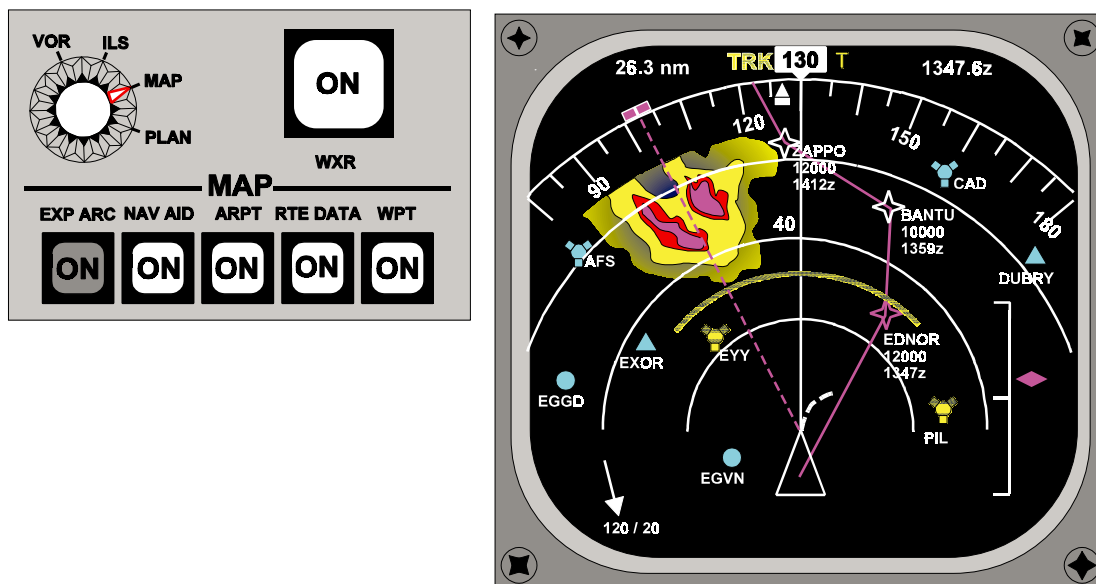

The mode used normally is the **MAP** display, which, in conjunction with the flight plan data programmed into a flight management computer, displays information against a moving map background with all elements to a common scale.

The symbol representing the aircraft is at the lower part of the display, and an arc of the compass scale, or rose, covering 45 degrees on either side of the instantaneous track, is at the upper part of the display.

Heading information is supplied by the appropriate inertial reference system and the compass rose is automatically referenced to magnetic North (via a crew-operated **MAG/TRUE** selector switch) when between latitudes 73°N and 65°S, and to true North when above these latitudes. When the selector switch is set at **TRUE** the compass rose is referenced to true North regardless of latitude.

The aircraft active route as derived from the FMC is shown as a magenta coloured line joining the waypoints. The **active waypoint** (the one the aircraft is currently navigating towards) is shown as a magenta coloured star. The other waypoints making up the active route are called **inactive waypoints** and are shown as a white star. Both identified by name.

Distance to next waypoint and time at next waypoint are shown at the top of the display Weather Radar (WXR) return data and range arcs are displayed when the WXR switch is on. Turbulence mode (+T) may be available as previously described.

Indications of other data such as wind speed and direction, lateral and vertical deviations from the selected flight path are also displayed.

The flight management computer (FMC) can predict events by combining current ground speed and lateral acceleration to show a display of either a curved trend vector, white, (during turns) or a range to altitude arc, green, (during climb or descent). Off route waypoints, Airports, Nav aids can all be shown in their relative position to the aircraft's progress and selected range. Additional waypoint information can be displayed when selected, Altitude, Time etc.

PLAN MODE

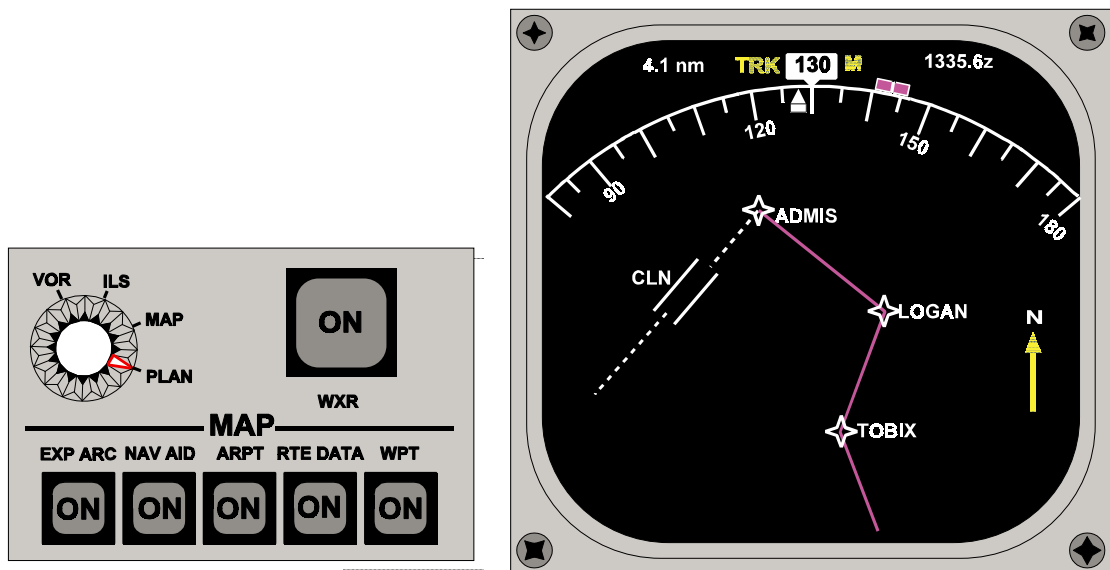

In 'PLAN' mode a **static** map background is used with active route data orientated to **true north**. Any changes to the route may be selected at the keyboard of the Flight Management Computer, and the display shown on the **EHSI**, so they can be checked before they are entered into the FMC.

The top portion of the EHSI remains the same as in the map mode.

This mode allows the pilot to review the planned route by using the FMC / CDU LEGS page.

Weather Radar display data is inhibited.

No wind speed or direction information

DATA SOURCE SELECTION

In the type of system described earlier, means are provided whereby the pilots can independently of each other, connect their respective display units to alternate sources of input data through a data source switch panel. e.g. the left or right Air Data Computer (ADC), the Flight Management Computers (FMC), the Flight Control Computers (FCC), and the Standby Inertial Reference Systems (IRS).

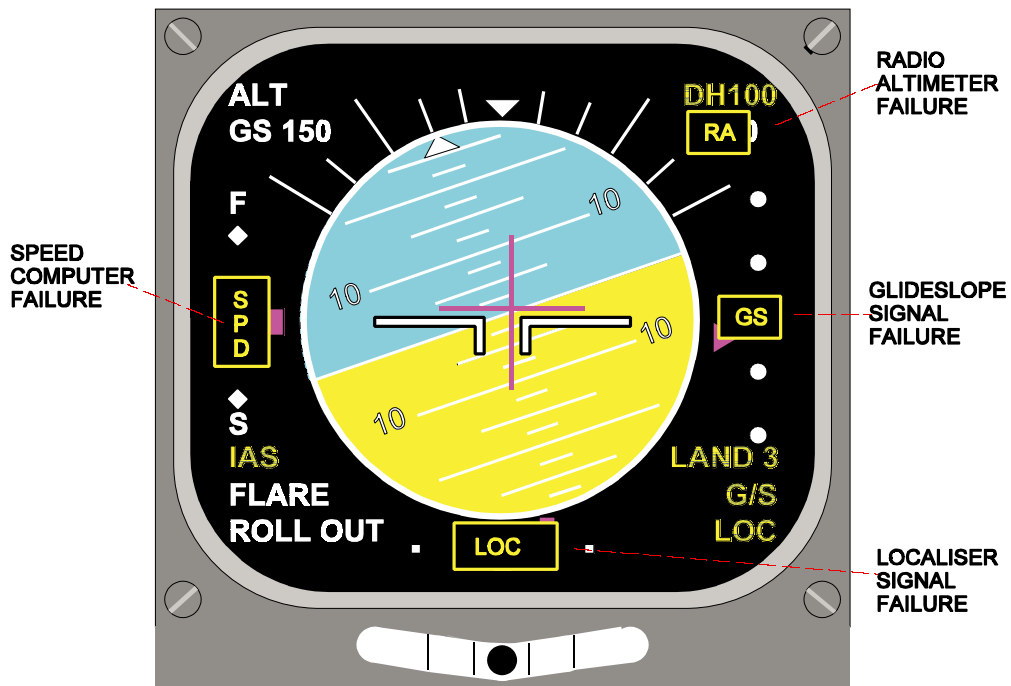

Figure 22.6 Failure Indications

FAILURE ANNUNCIATION



The failure of data signals from such systems as the ILS and radio altimeter is displayed on each EADI and EHSI in the form of yellow flags ‘painted’ at specific matrix locations on their CRT screens.



In addition, fault messages may also be displayed, for example, if the associated flight management computer and weather radar range disagree with the control panel range data, the discrepancy message ‘WXR/MAP RANGE DISAGREE’ appears on the EHSI.



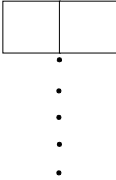

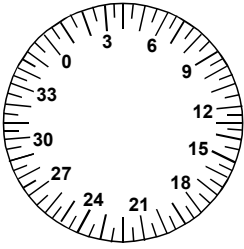
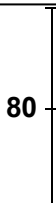
NAVIGATION DISPLAYS

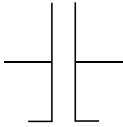
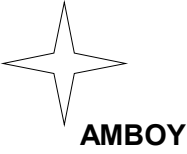
The following symbols can be displayed on each HSI depending on EFI Control Panel switch selection. Symbols can be displayed with different colours but the general colour presentation is as follows:

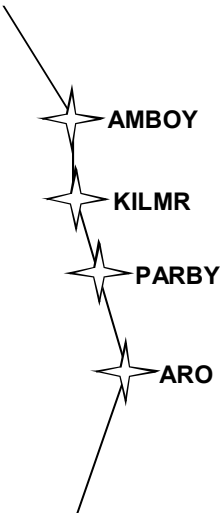
- GREEN (G)** engaged flight mode displays, dynamic conditions.
- White (W) present status situation, scales, armed flight mode displays
- MAGENTA (M)(pink)** command information, pointers, symbols, fly-to condition
- CYAN (C)(blue)** non-active and background information
- RED (R)** warning
- AMBER (A)** cautionary information, faults, flags
- BLACK (B)** blank areas, display “off”

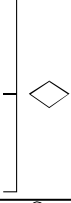
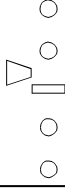
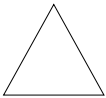
Symbol	Name	Applicable Modes	Remarks
200 nm / 4.4 nm or DME 124 / DME 24.6	Distance Display (W)	PLAN, MAP or VOR, ILS	Distance is displayed to next FMC Waypoint(nm) or tuned Navaid(DME).
HDG  M	HEADING Orientation(G) Indicator(W) Reference(G)	PLAN, MAP VOR, ILS	Indicates number under pointer is a heading - box indicates actual heading. Referenced to Magnetic North between 60deg South and 73deg North if selected and True North when above those latitudes.
0835.4z	ETA Display (M) & (W)	PLAN, MAP	Indicates ETA at active Waypoint based on current ground speed.
	Selected Heading Marker(M)	PLAN, MAP VOR, ILS	Indicates the heading set in the MCP. A dotted line(M) extends from the marker to the aeroplane symbol for ease in tracking the marker when it is out of view (except plan mode).
	Expanded Compass Rose(W)	PLAN, MAP VOR, ILS	Compass Data is provided by the selected IRS (360 deg available but approximately 70 deg is displayed)
	Full Compass Rose(W)	Full VOR, Full ILS	Compass Data is provided by the selected IRS.
	Present Track Line and Range Scale	MAP VOR, ILS	Predicts Ground Track which will result with present heading and winds. Displayed Range Mark is one-half the actual selected range.

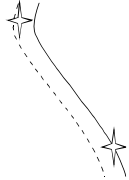
	<p>Aeroplane Symbol(W)</p>	<p>MAP VOR, ILS</p>	<p>Represents the aeroplane and indicates its position at the apex of the triangle.</p>
	<p>Aeroplane Symbol(W)</p>	<p>Full VOR, Full ILS</p>	<p>Represents the aeroplane and indicates its position at the centre of the symbol.</p>
	<p>Waypoint Active(M) Inactive(W)</p>	<p>MAP, PLAN</p>	<p>Active - Represents the waypoint the aircraft is currently navigating to. Inactive - Represents a navigation point making up the selected active route.</p>
	<p>Altitude Range Arc(G)</p>	<p>MAP</p>	<p>When intersected with the track line, it predicts the point where the reference altitude will be reached.</p>
	<p>Trend Vector</p>	<p>MAP</p>	<p>Predicts aeroplane directional trend at the end of 30, 60 and 90 second intervals. Based on bank angle and ground speed. Three segments are displayed when selected range is greater than 30nm, two on the 20nm and one segment when on the 10nm scale.</p>
	<p>Active Route(M) Active Route Mod's(W) Inactive Route(C)</p>	<p>MAP, PLAN</p>	<p>The active route is displayed with continuous lines(M) between waypoints. Active route modifications are displayed with short dashes(W) between waypoints. When a change is activated in the FMC, the short dashes are replaced by a continuous line. Inactive routes are displayed with long dashes(C) between waypoints.</p>

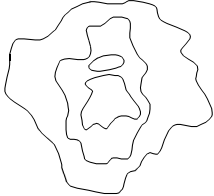
	Vertical Pointer(M) and Deviation Scale(W)	MAP	Displays vertical deviation from selected vertical profile(pointer) in MAP mode during descent only. Scale indicates +/- 400ft deviation.
	Glide slope Pointer(M) and deviation Scale(W)	ILS	Displays Glide slope position and deviation in ILS mode.
	Drift Angle Pointer(W)	Full VOR, Full ILS	Displays difference between FMC track angle and IRS heading.
	Wind Speed and Direction(W)	MAP, VOR, ILS	Indicates wind speed in knots and wind direction with respect to the map display orientation and compass reference.
	Offset Path and Identifier(M)	MAP, PLAN	Presents a dot-dash line parallel to and offset from the active route after selection on the FMC CDU.
	North Pointer(G)	PLAN	Indicates map background is orientated and referenced to true north.
	Altitude Profile Point and Identifier(G)	MAP	Represents an FMC calculated point and is labelled on the flight plan path as "T/C" (top of climb), "T/D" (top of descent) and "S/C" (step climb).
	Weather Radar Returns Mapping Radar Returns (both G,A,R)	MAP, VOR, ILS	Multicoloured returns are presented when either "WXR ON" switch is pushed. Most intense regions are displayed in Red, lesser Amber lowest intensity Green.

EXAMPLE DISPLAYS

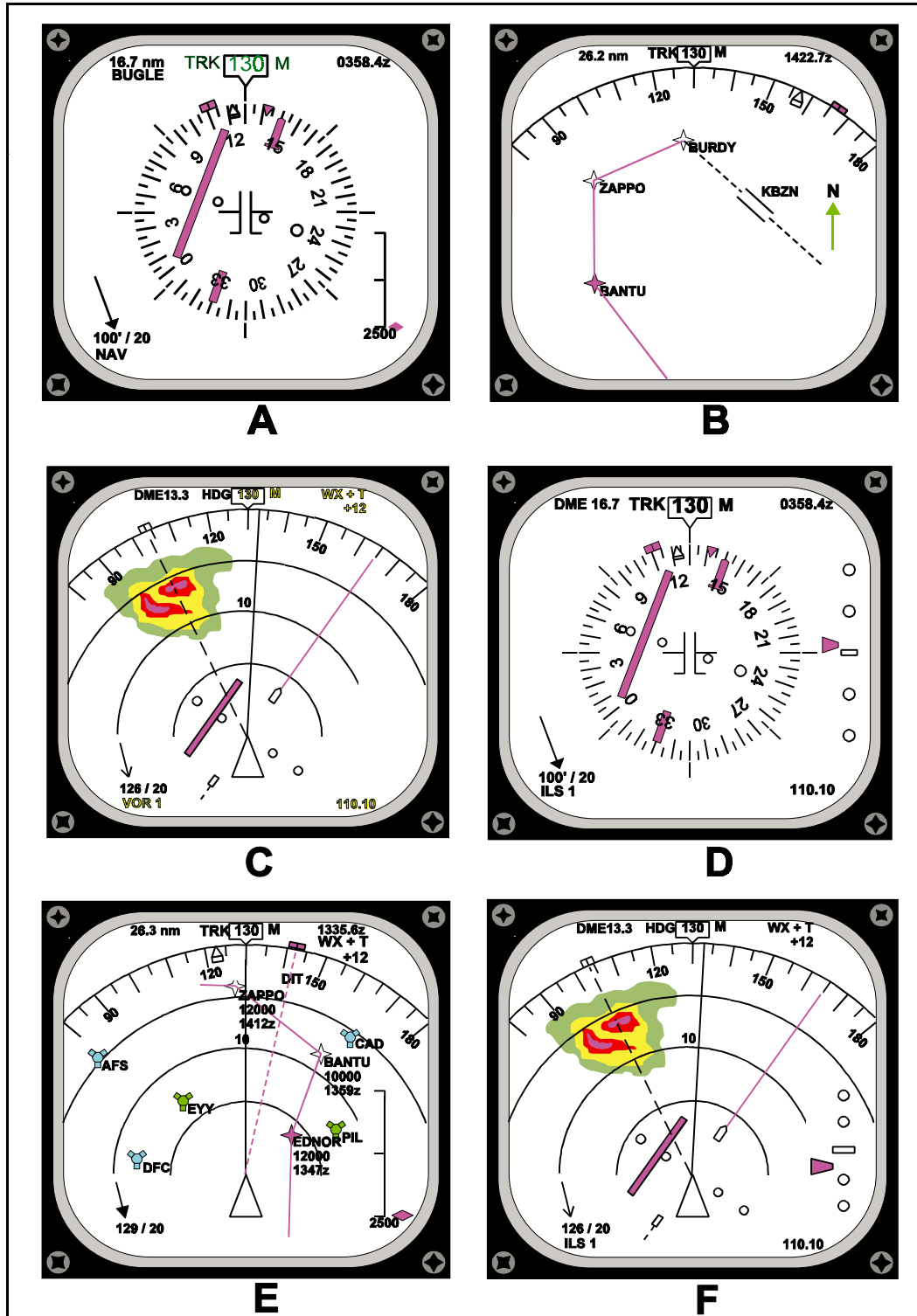

Figure 22.7

QUESTIONS

Refer to Appendix A, showing various EHSI displays and answer the following questions:

1. The displays marked A, B, C, and D are respectively:

a.	Plan	Map	ILS	VOR
b.	VOR	ILS	Expanded ILS	Plan
c.	Map	VOR	ILS	Plan
d.	Map	ILS	Expanded VOR	Plan

2. Refer to the display marked E and identify the correct statement:
 - a. The aircraft is closing the localiser from the right, heading 130°M and is approaching the glide path from above
 - b. When established on the localiser the inbound heading will be 165°M.
 - c. The aircraft's track is 165°M
 - d. The localiser centre line is 133°M.

3. On display D the track from ZAPPO to BANTU is:
 - a. 310°M
 - b. 130°T
 - c. 360°M
 - d. 180°T

4. On display centre C the centre of the weather returns is:
 - a. 106° relative, 18 nm
 - b. 332° relative, 13 nm
 - c. 100°M, 130 nm
 - d. 30 nm left of track, 15 nm ahead.

5. The drawing below is shown on the (i)..... is displaying (ii)..... and (iii).....

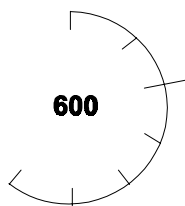

- | | (i) | (ii) | (iii) |
|----|------------------------|-----------------------------|------------------------------|
| a. | Primary Flight Display | 600 kt TAS | 200ft RA |
| b. | Navigation Display | 600ft RA | 200ft DH |
| c. | EADI | 600ft | 200ft |
| d. | EHSI | Radio Altitude
600 kt GS | Decision Height
200ft AGL |

6. This following yellow symbol appears in place of the normal radio altitude display when:



- a. the selected radio altitude has been reached
 - b. the radio altitude needs re-setting on the EHSI
 - c. there is a failure of the radio altimeter
 - d. the aircraft descends below 1000ft AGL.
7. The following symbols A, C, and E are best described respectively as:



A



B



C



D



E

- a. off route waypoint, airport navigation aid.
 - b. next waypoint, navigation aid, airport.
 - c. off route waypoint, navigation aid, a navigation point making up selected route.
 - d. active waypoint aircraft currently navigating to, navigation aid, off route waypoint.
8. When using EHSI, weather radar may be displayed on following settings:
- a. map, VOR/ILS.
 - b. VOR/ILS, map, expanded plan.
 - c. expanded map, VOR/ILS, plan.
 - d. map, expanded VOR/ILS.
9. WXR display is controlled from:
- a. captains EHSI control only.
 - b. co-pilots EHSI control only.
 - c. a special control panel.
 - d. both captains and co-pilots EHSI control panels.
10. Decision height is adjusted and set on the:
- a. flight management computer.
 - b. HSI section of the EFIS control panel.
 - c. ADI section of the EFIS control panel.
 - d. ADI or HSI
11. WXR display is on:
- a. the captains CRT only.
 - b. the co-pilots CRT only.
 - c. a special screen.
 - d. on both the captains and co-pilots CRTs.

12. Airspeed is shown:
- only on the captains EHSL.
 - on both EADIs.
 - on both EHSIs.
 - only on the flight management CRT.
13. With an EFIS flight director using IRS guidance, reference north can be:
- magnetic north only.
 - magnetic north between 73°Nth and 65°Sth and true north above these latitudes.
 - magnetic north between 65°Nth and 73°Sth and true north above these latitudes.
 - magnetic north between 75°Nth and 75°Sth and true north above these latitudes.
14. Modes available for (EFIS) HSI on some units are:
- airspeed and Mach.
 - MAP and PLAN.
 - VOR, ILS, MAP and AUTO TRIM.
 - only from manometric sources.

15. The EFIS symbols for a navaid and enroute waypoint are:

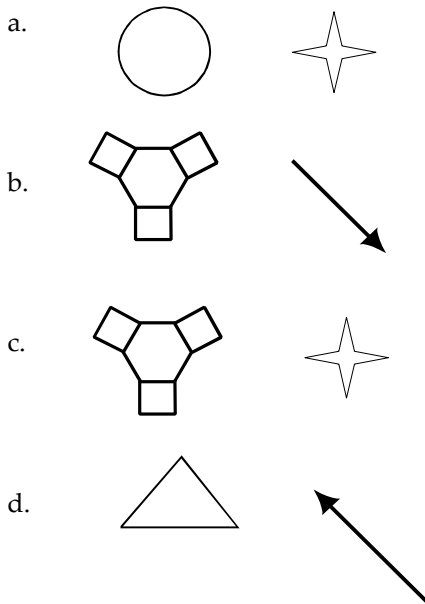

16. An EFIS as well as having a control panel, symbol generators and a remote light sensor also has:
- EADIS and EHSIs
 - EHSIs and altitude indicator
 - EADIs and EICAs
 - EADI and WXR display tubes.

ANNEX A

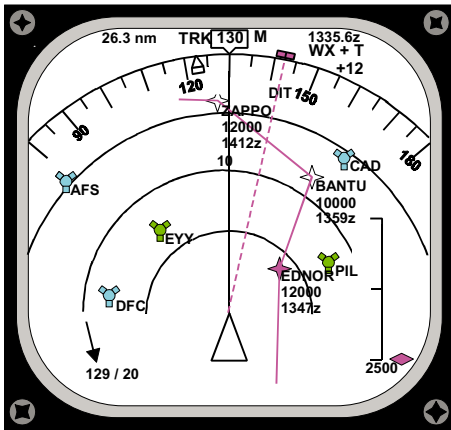

A

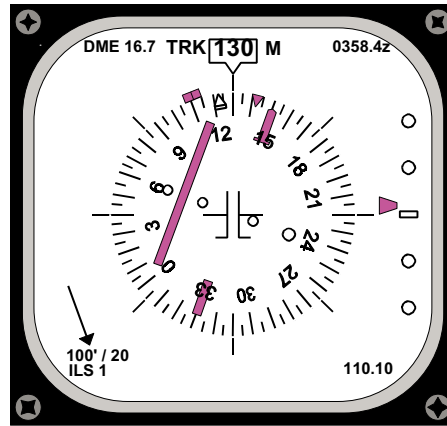

B



C

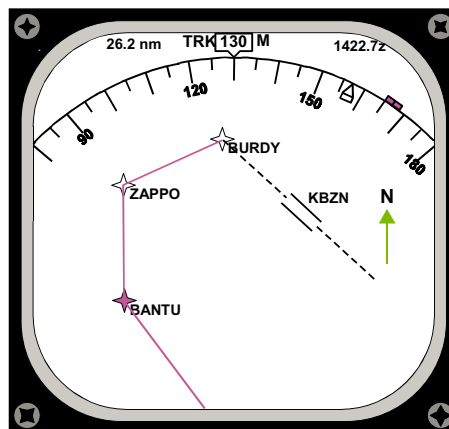

D



E

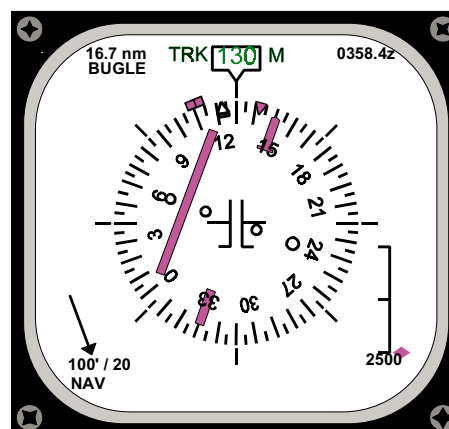

F

ANSWERS

- | | |
|----|---|
| 1 | D |
| 2 | A |
| 3 | D |
| 4 | B |
| 5 | C |
| 6 | C |
| 7 | D |
| 8 | D |
| 9 | D |
| 10 | C |
| 11 | D |
| 12 | B |
| 13 | B |
| 14 | B |
| 15 | C |
| 16 | A |

CHAPTER TWENTY THREE

HEAD-UP DISPLAY

Contents

THE HEAD-UP DISPLAY 311

THE UNITS OF A SYSTEM 312

FLIGHT DATA AVAILABLE 312

THE HUD COMBINER ASSEMBLY 313

HUD INFORMATION AVAILABLE 314

THE AMBIENT LIGHT SENSOR. 314

CONFORMAL DISPLAY 314

RUNWAY APPROACH 316

TAKE-OFF DISPLAY. 317

HORIZONTAL SITUATION INDICATOR 318

NON-CONFORMAL DISPLAY. 319

COURSE DEVIATION INDICATOR. 320

TRAFFIC ALERT AND COLLISION AVOIDANCE 321

WARNING AND CAUTION DISPLAY 321

THE HEAD-UP DISPLAY

The Head-up Display is an extension of the Electronic Flight Instrument System. It presents attitude and navigation information to the pilot on an electronic display in a format which is easy, with experience, to read and importantly is in the eye line of the pilot when transferring from instrument to visual flight conditions.

The system generally referred to as “the HUD”, is fully integrated with digital computer-based navigation and flight systems. It utilises a Display Guidance Computer, a Display Controller and an Overhead Unit with Combiner Assembly to provide information more usually presented on types of Electronic Attitude Director Indicator (EADI / PFD) and Electronic Horizontal Situation Indicator (EHSI / ND).



Figure 23.1

Figure 23.1 is an example of the A300 series of aircraft PFD and ND and it should be remembered that all of this information may be shown upon a HUD if so desired by the company but the information is generally organised as indicated below.

The system is therefore extremely advanced, not only in terms of physical construction, but also in the extent to which it can present attitude and navigational data to the pilot of an aircraft.

THE UNITS OF A SYSTEM

The system is made up of the following units which provide the functions as indicated:

Display Guidance Computer:

- Combines the Flight Guidance and Symbol generation for the HUD.
- Generates EFIS / AFCS information onto the HUD using analogue displays.
- Provides flight information as requested by the pilot.

Display Controller:

- Controls the various modes of operation available for the HUD.
- Activates / deactivates the HUD.
- Provides access for engineering fault investigation.

Overhead Unit with Combiner Assembly:

- The Overhead Unit projects the HUD symbology onto the Combiner Assembly.
- The Combiner Assembly is situated in the pilots "viewing area" and displays stroke-written graphics that orientate the pilot to the current flight situation.

FLIGHT DATA AVAILABLE

The display unit **will** provide information from the following sources:

- Air Data Computer(ADC)
- Inertial Reference Unit(IRU)
- Radio Altimeter(RA)
- Radio Navigation
- Flight Management System(FMS)

The display **may** provide information from the following sources:

- Traffic Alert and Collision Avoidance System(TCAS)
- Windshear Warning System
- Global Positioning System(GPS)
- Microwave Landing System(MLS)

The lists indicated are not exhaustive but can be said to be a representative selection of the information that may be displayed dependant upon aircraft equipment fitted and company requirements.

THE HUD COMBINER ASSEMBLY

The Combiner Assembly is a foldaway glass see-through screen mounted in front of the pilot and placed in his eyeline to the outside world. It is suspended from the overhead structure of the cockpit where it is attached to the Display Guidance Computer(DGC).

The image projected onto the Collimator Assembly by the DGC from its electro-optical unit is reflected so that the image produced gives a real time impression of current flight information and aircraft flight profile. The information is presented so that the pilot may look through the display and relate the presentation to his view of the skyline in front of the aircraft. The presentation is achieved by using a Synthetic Hologram coating upon the glass of the Collimator Assembly which reflects the colour of the projected display but allows light from outside to pass through to the pilot.

The Collimator Glass may be raised from in front of the pilot and stored if required and will in any event spring out of the way to avoid injury if the pilot was to strike it by accident.

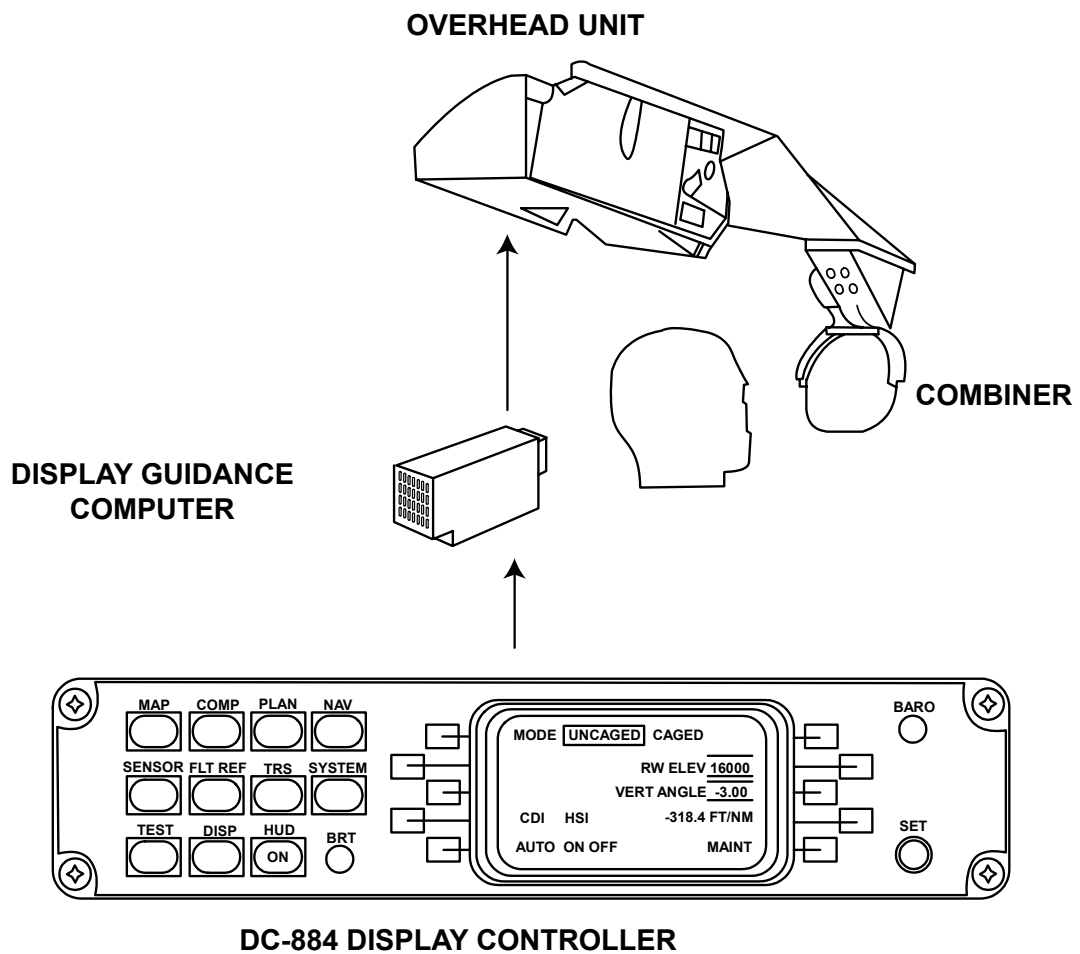

HUD INFORMATION AVAILABLE

Typically a HUD can provide the following information for display to the pilot - this may vary dependant upon manufacturer and company requirement:

- Aircraft Attitude
- Autopilot Mode in use
- Flight Director Mode in use
- Flight Director Command symbology
- Vertical deviation from selected datum
- Radio Altitude(RA)
- Decision Height(DH)
- Minimum Descent Altitude(MDA)
- Altitude Awareness Cue
- Roll Scale
- Slip / Skid Information
- Low Speed Awareness
- Marker Beacon Indications(O - M - I)
- Altitude (Metres / Feet)
- Airspeed / Mach No
- Vertical Speed (Tape and Digital indications)
- Heading
- Selected Course
- Lateral Deviation from selected course
- Drift Angle
- Distance
- Flight Path Vector
- Synthetic Airport / Runway
- Guidance Symbology
- (Test Displays)

This list is not exhaustive but should give an indication of the information that may be shown to the pilot. Clearly all of this information is available upon a number of “head-down” presentations but by taking this into the eye-line of the pilot the requirement for eye movement and refocusing is removed thus making bad weather approaches more easily achieved. The standard colour for presentation is green and this is maintained for all of the symbology mentioned above.

THE AMBIENT LIGHT SENSOR

The HUD presentation intensity can, as with EFIS, be automatically controlled for brightness through the use of an Ambient Light Sensor. The sensor will maintain a set brightness level as set by the pilot to cater for cockpit light conditions as they change during the flight.

CONFORMAL DISPLAY

As described above most of the information that is displayed can be seen in similar format on a “head-down” display somewhere in the cockpit. However, the whole purpose of the system is to allow the pilot to look through the information presented and be able to immediately match this information to the real world outside the cockpit. The figure below 26.3 gives an indication of the conformal display symbology that we may expect to see **at various stages of an approach** on the Honeywell HUD.

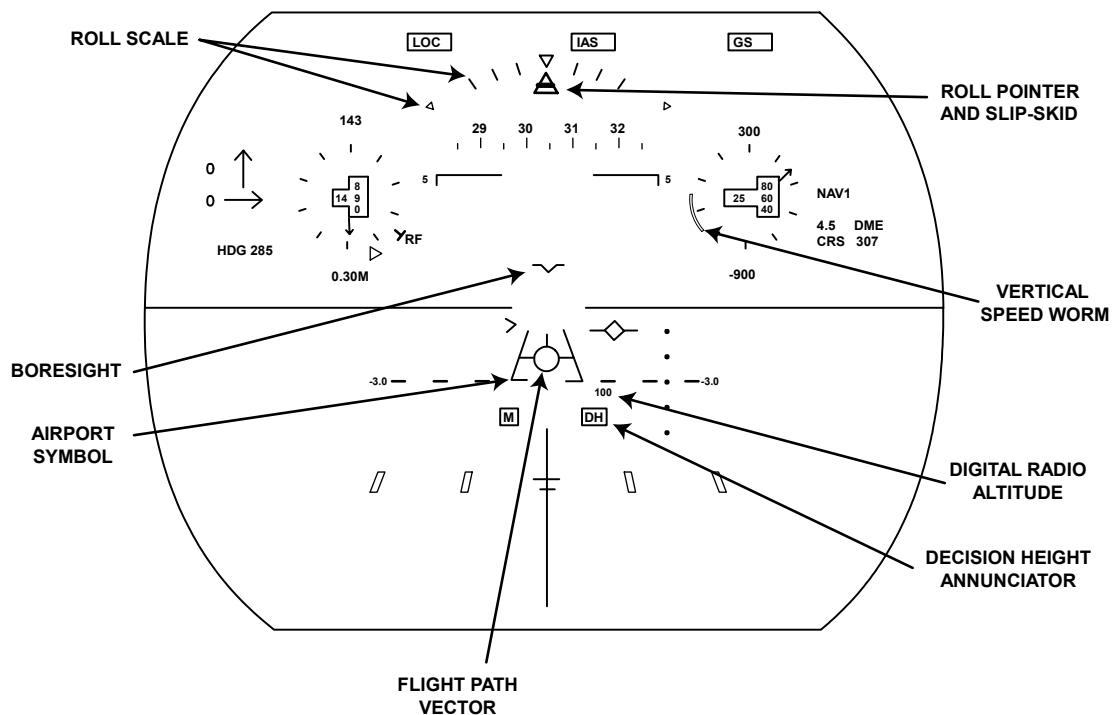

Conformal Display Symbols (general):

- Flight Path Vector (FPV) - The FPV is the primary symbol for control of the aircraft and can be used to show course and flight path deviations against selected scales in a similar fashion to the more usual Flight Director displays. However, it does not show nose attitude as with an ordinary ADI system and will only be active at airborne speeds (60kts plus in the Honeywell system).
- Roll Scale triangles - The Roll Scale is shown by “tick marks” at 100 intervals and allows a presentation of roll up to 450 Angle of Bank (AOB) by the introduction of an extra triangle at 450 which appears when the aircraft AOB is greater than 320.
- Horizon Line - A line with a gap in the centre into which the Flight Path Vector (FPV) fits.
- Boresight - The aircraft reference symbol around which all earth referenced information is manoeuvred.
- Airport Symbol - Shown at the end of the runway when on approach it changes to a Runway Symbol as the aircraft descends below 325ft AGL but will indicate accurately only if correct runway elevation has been entered on the Display Controller(DC)HUD Menu.
- Conformal Lateral Deviation Scale - Used in a number of applications to show displacement from centreline.
- Decision Height Annunciation - A hollow box is shown when the aircraft is 100ft above decision altitude to change as the aircraft passes the selected altitude and shows either MDA or DH in the box.
- Airspeed Indication - If IAS / Mach is selected to Mach, the digital readout will indicate Mach and the dial IAS.

RUNWAY APPROACH

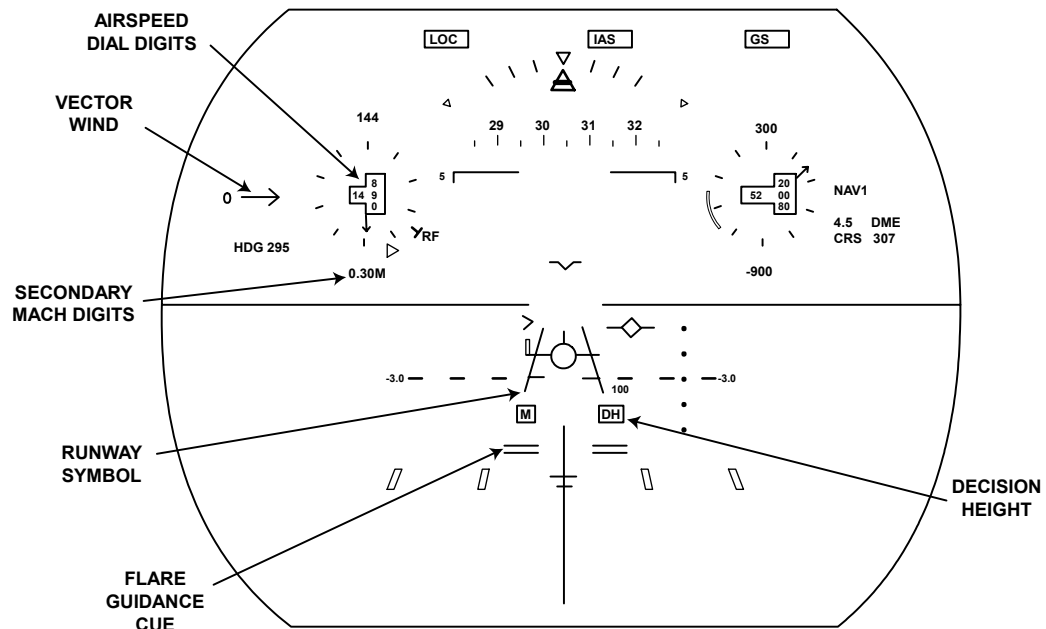

Runway Approach Symbols

- Runway Symbol - The symbol is presented as the aircraft descends below 350ft superimposed upon the airport symbol which will in turn disappear as the aircraft goes below 325ft. (As with the airport symbol the runway information must be entered into the system accurately to ensure accurate picture presentation.)
- Flare Guidance - The symbol becomes active below 100ft Radio Altitude and when armed will move laterally with the FPV and can be expected to move up to the FPV from below until the wings of the aircraft symbol fit between the two bars.

When the aircraft goes below 50ft the guidance switches from glideslope to Flight Director vertical commands which are used to prompt the flare for landing (the pilot will need to touchdown and rollout using normal visual procedures prompted by the system).

TAKE-OFF DISPLAY

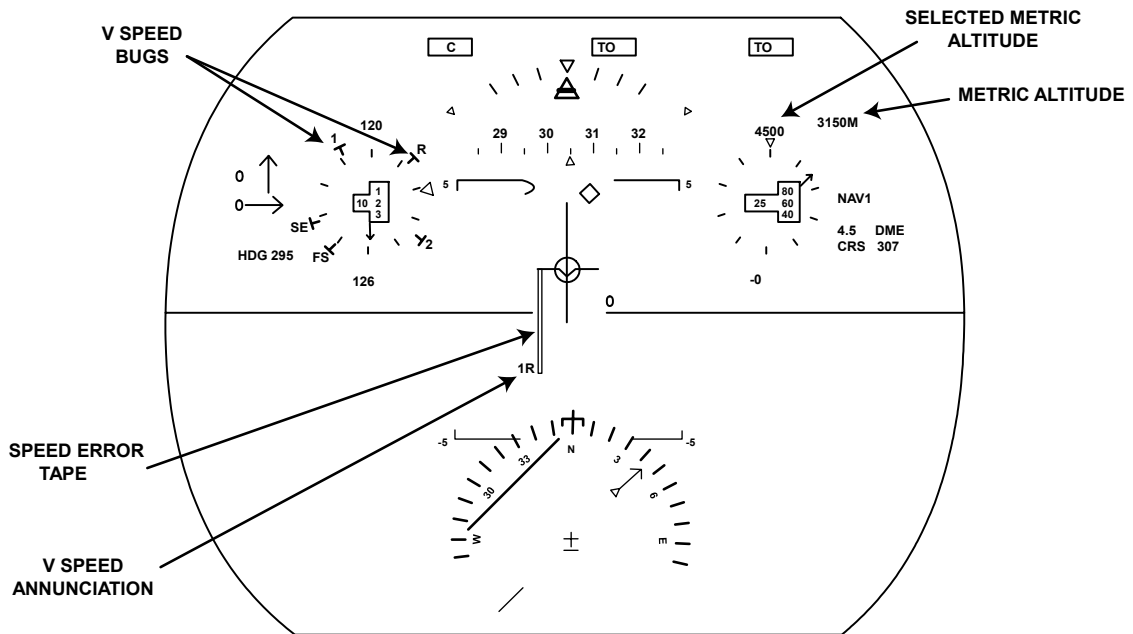

Take-off Display Symbols

- VSPEED Bugs - These can be placed upon the presentation either on the circular airspeed dial or on the Speed Error Tape extending from the FPV aircraft symbol.
- Speed Error Tape - Rising or descending from the right wing of the FPV it represents the difference between selected and achieved airspeed (above = current airspeed above selected airspeed and below the opposite).
- Metric Altitude - Altitude can be offered in metres or feet and the selection is indicated by an "M" after the figure if metres are selected. Selected Altitude readout is also possible and this indicates when the aircraft is within 500ft of selected altitude to give warning of imminent level-off.
- Selected Heading Digital Readout - A digital readout of selected heading may be shown and this is preceded by the identifier "HDG".

HORIZONTAL SITUATION INDICATOR

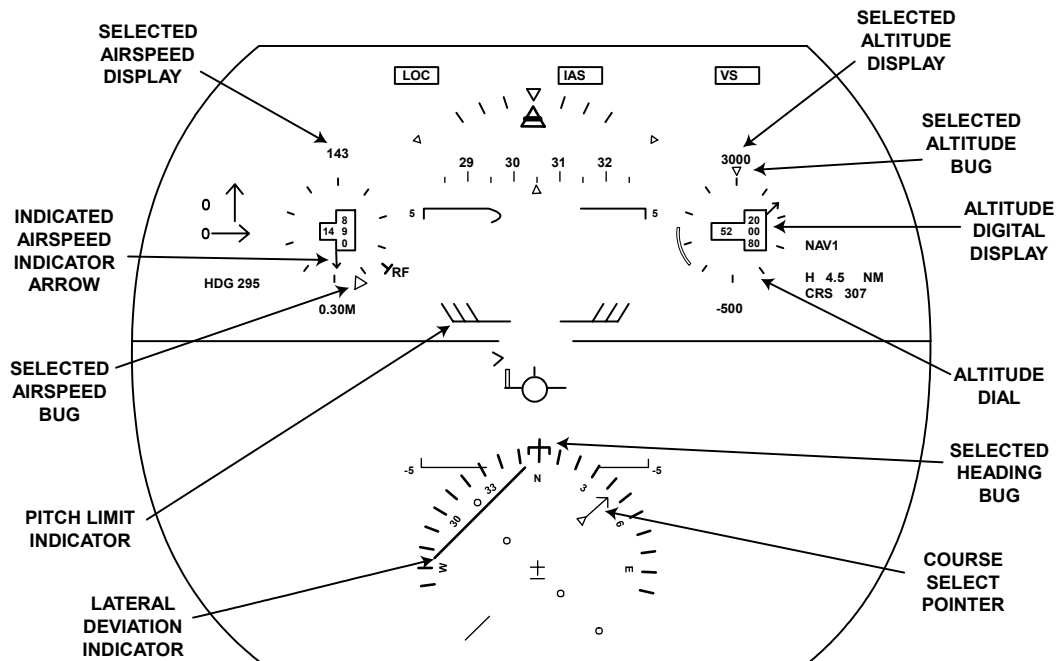

Horizontal Situation Indicator(HSI) Display Symbols

- Selected Airspeed Bug and Display - Set manually or through the FMS by the pilot this indicates digitally the reference speed selected and by using the bug an indication of low or high speed against the reference may be shown.
- Pitch Limit Indicator (PLI) - As with any system it is important to know when the aircraft is approaching a stall and this can be achieved through a stick shaker as well as visual cues. As the aircraft approaches the relevant pitch limit (approximately 0.75 of the available AOA with this Honeywell System) at a given weight, altitude and speed the PLI and the FPV will come close together warning the pilot of an imminent stall condition.
- Selected Altitude Display - The selected Altitude Bug travels around the outside of the altitude analogue scale and will be visible when the aircraft is within 500ft of selected altitude (this can be shown as either feet or equivalent metric values).

NON-CONFORMAL DISPLAY

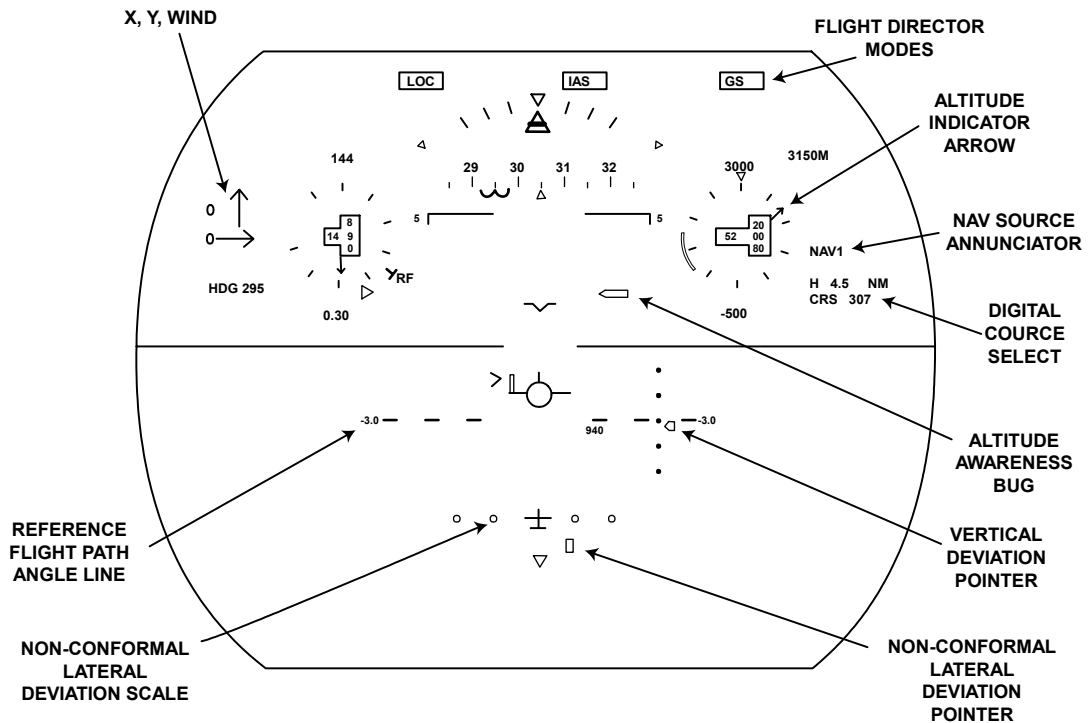

Non-Conformal Display Symbols

- Reference Flight Path Angle Line - The dashed line represents the reference FPA selected and this may be selected above or below the horizon to cater for climb / descent profiles.
- Vertical Deviation Scale - This can be selected to show either Vpath or Glideslope deviation (if the reference is from the long range navigation part of the FMS then deviation from the VNAV path is shown).

COURSE DEVIATION INDICATOR

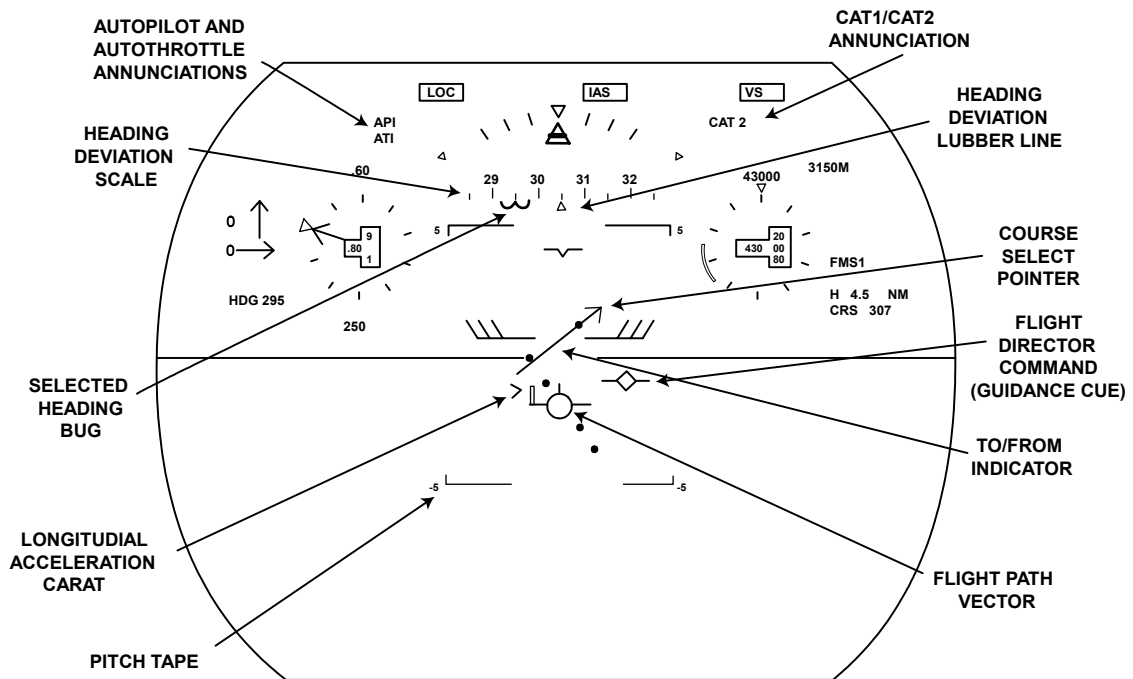
**Course Deviation Indicator Display Symbols:**

Flight Path Vector (FPV) - placed to indicate the lateral deviation of the aircraft within the selected course profile which moves around the FPV. In Figure 23.7 the aircraft is to the right of the selected course, this is indicated to us by the Course Selector Pointer being offset to the left of the line of four dots.

Autopilot / Autothrottle Modes - as with any of these systems it is important to know which mode is armed and in use and this is achieved by a number of annunciators set upon the HUD.

Heading Deviation Scale - the heading tape moves left / right across the screen and allows for presentation of differences between heading selected and that currently being achieved.

Longitudinal Acceleration Carat - this device allows the pilot to view his airspeed relative to a set value and identify if the aircraft is fast or slow against the datum, if the aircraft is at its required speed the arrow will indicate against the end of the FPV wing.

TRAFFIC ALERT AND COLLISION AVOIDANCE

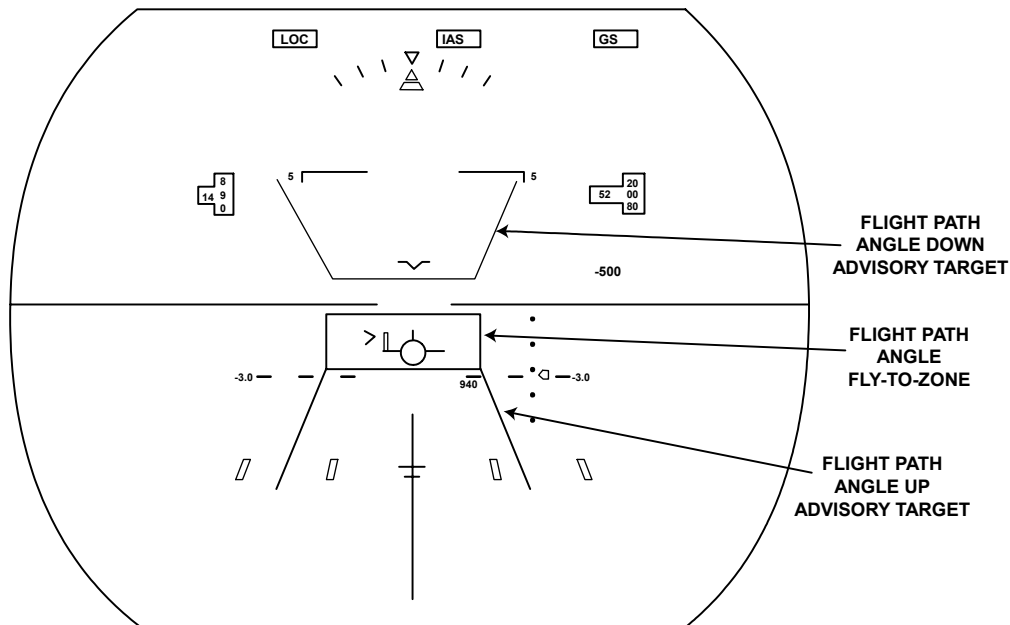

Traffic Alert and Collision Avoidance System (TCAS)

TCAS information may be shown on the HUD as indicated above and will take the form of Resolution Advisory(RA) commands which are in turn translated into Flightpath Angle(FPA) commands for presentation to the pilot.

Flightpath Angle Up / Flightpath Angle Down advisory commands are generated to manoeuvre the aircraft into the Flightpath Angle Fly-to Zone which is a box where the aircraft may fly in safety with relation to detected RAs.

WARNING AND CAUTION DISPLAY

In the paragraphs above we have described the format of information, based upon a current Honeywell System, that may be placed before the pilot at take-off in flight and on the approach to land. We may note from the previous discussion that just about any information generated by the aircraft can be displayed dependant upon the requirements of the company that is to utilise the system.

It is equally important to recognise that the system may provide warnings of mismatch between data from sensors or imminent / actual failure of systems being utilised by the aircraft. Importantly for the pilot, the HUD can also display warning of Windshear on approach, assuming the appropriate sensors are fitted to the aircraft, thus allowing the pilot to take the necessary actions to achieve a safe landing.

CHAPTER TWENTY FOUR

BASIC COMPUTERS

Contents

COMPUTERS 325

ANALOGUE COMPUTERS 325

DIGITAL COMPUTERS 325

BINARY NUMBER SYSTEM 326

CONVERTING DECIMAL NUMBERS TO BINARY NUMBERS. 327

OCTAL NOTATION SYSTEM 330

HEXADECIMAL NUMBER SYSTEM 331

DIGITAL COMPUTER COMPONENTS (HARDWARE) 332

INPUT OUTPUT DEVICES 333

MEMORY 333

AIRCRAFT SYSTEMS 334

QUESTIONS 335

ANSWERS 340

COMPUTERS

A computer may be defined as: **A device or set of devices that can store data and a program that operates on the data. A general purpose computer can be programmed to solve any reasonable problem expressed in logical and arithmetical terms.**

The first fully operational general purpose computer, electromechanical and using binary digits was the Z3, built in Germany in 1941 by Konrad Zuse.

Basically there are two types of computer:

- Analogue
- Digital

By far the most common is the Digital Computer or Micro Processor which now plays a part in most aspects of everyday life.

ANALOGUE COMPUTERS

An analogue computer uses continuous physical variables such as voltage or pressure to represent and manipulate the measurements it handles.

Analogue computers are used as electronic models or **analogues** of mechanical or other systems in cases where conducting experiments on the system itself would be costly, time consuming or dangerous. For example when designing a bridge or aircraft wing or any structure where motion can occur, the engineer must know beforehand how it will react to various physical variables such as wind speed and temperature.

In recent years analogue computers have become less popular because it is now possible to program digital computers to simulate moving physical systems.

The remainder of this chapter will deal with digital computers and their use in aircraft.

DIGITAL COMPUTERS

Digital Computers use digital data (binary data) in their operations. This form of data has only two levels of voltage as opposed to the analogue systems continuous variables. The two levels correspond to **ON** or **OFF** ie switching circuits. Digital circuits are **two state** circuits. Normally when working on paper we count from zero to nine - the decimal number system. When the digital computer works it has to use the **ON - OFF**, two state or **BINARY** number system.

BINARY NUMBER SYSTEM

The binary number system represents different quantities using only two symbols, 1 and 0. If a quantity larger than 1 must be represented by binary numbers, the symbols systematically repeat. As in the decimal system, the binary system repeats by adding to the **left** of the first digit.

Therefore a binary number may be written: 101

How can the equivalent number be represented in the familiar decimal number system?

In the decimal system the least significant digit is on the right and the most significant digit on the left. The same applies in the binary system.

The 1 on the right represents 1×2 to the power 0 or 2^0 which is decimal 1.

The 0 in the middle tells us there is no value in the column 2^1 so there is no decimal 2.

The 1 on the left indicates there is 1×2 to the power 2 or 2^2 which is decimal 4

By adding the decimal one derived from the binary 1 on the left to the 4 derived from the binary 1 on the right we get decimal number 5.

Binary 101 = Decimal 5

The table below shows the specific value of a binary digit in positions of 1 to 10, with the least significant number on the right and the most significant number on the left.

BINARY DIGIT	10th	9th	8th	7th	6th	5th	4th	3rd	2nd	1st
POWER	29	28	27	26	25	24	23	22	21	20
DECIMAL VALUE	512	256	128	64	32	16	8	4	2	1

Using the table it is easy to convert binary numbers into their decimal equivalents, you simply place the binary number under the table, note the powers of two above the binary ones and add them together.

The table below shows another example in addition to the previous number conversion. Note that binary zeros are not counted.

Convert binary 111011 to decimal:

Binary digit	6th	5th	4th	3rd	2nd	1st	
Power	25	24	23	22	21	20	
Decimal value	32	16	8	4	2	1	
				1	0	1	4 + 1 = 5
	1	1	1	0	1	1	32 + 16 + 8 + 2 + 1 = 59

CONVERTING DECIMAL NUMBERS TO BINARY NUMBERS

To change decimal numbers to binary numbers we simply progressively divide the decimal number by 2 and record the remainder, the remainder being the binary number:

Example 1: Convert decimal 96 to binary:

Quotient		Remainder
$\frac{96}{2}$	48	0 (last binary digit)
$\frac{48}{2}$	24	0
$\frac{24}{2}$	12	0
$\frac{12}{2}$	6	0
$\frac{6}{2}$	3	0
$\frac{3}{2}$	1	1
$\frac{1}{2}$	0	1 (first binary digit)

Decimal number 96 = binary number 1100000

Example 2: Convert decimal 18 to binary

Quotient		Remainder
$\frac{18}{2}$	9	0
$\frac{9}{2}$	4	1
$\frac{4}{2}$	2	0
$\frac{2}{2}$	1	0
$\frac{1}{2}$	0	1

Decimal number = 18
Binary number = 10010

Example 3: Convert decimal 69 to binary

Quotient		Remainder
$\frac{69}{2}$	34	1
$\frac{34}{2}$	17	0
$\frac{17}{2}$	8	1
$\frac{8}{2}$	4	0
$\frac{4}{2}$	2	0
$\frac{2}{2}$	1	0
$\frac{1}{2}$	0	1

Decimal number = 69
Binary number = 1000101

Positive Logic

Binary 1 is usually represented by a positive voltage +5v or +28v and binary 0 by zero volts (earth). This is known as positive logic.

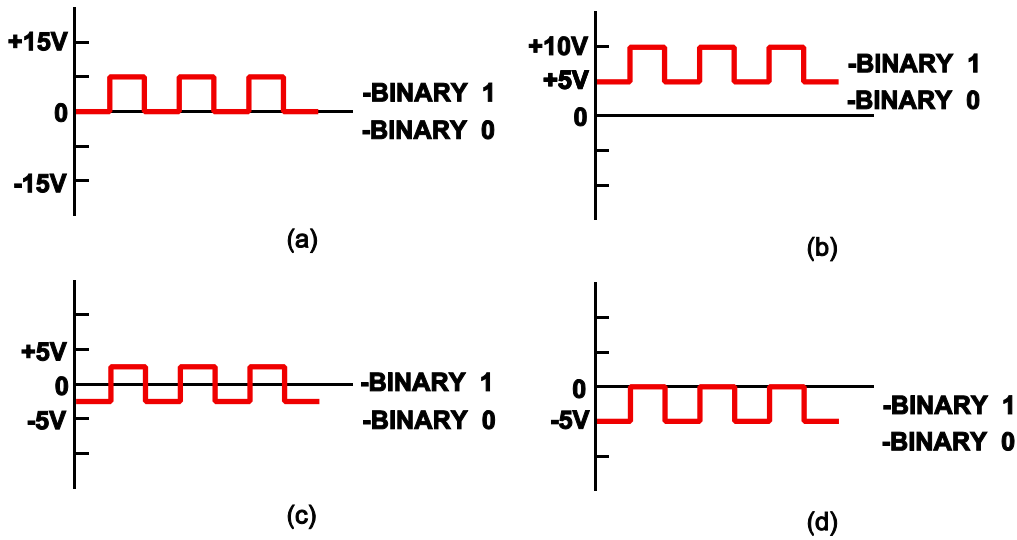

Four Examples of Positive Logic Digital Signals

- (a) Binary 1 = +7.5 V, Binary 0 = 0 V
- (b) Binary 1 = +10 V, Binary 0 = +5 V
- (c) Binary 1 = +2.5 V, Binary 0 = -2.5 V (Bipolar Binary)
- (d) Binary 1 = 0 V, Binary 0 = -5 V

Negative Logic

When binary 1 is represented by a negative number and binary 0 by zero (earth). This is called negative logic and is less common.

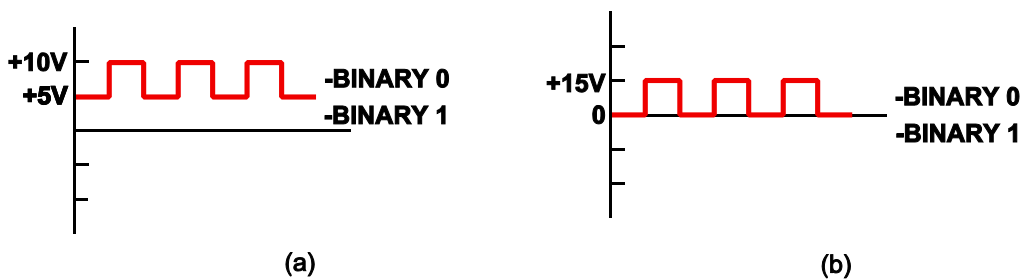

Two Examples of Negative Logic Digital Signals

- (a) Binary 1 = +5 V, Binary 0 = +10 V
- (b) Binary 1 = 0 V, Binary 0 = +15 V

As can be seen from the examples on the previous page, when counting in the binary system using just 0 and 1, many more columns are required. Successive columns from the right represent increasing powers of 2:

24 23 22 21 20 etc

The term **BIT** may be used when referring to a **binary digit**. One bit is equal to one binary digit. A bit will always be a high or low logic level (+ voltage and 0 voltage for example).

Bits handled as a group are referred to as a **BYTE**. Therefore, an eight bit binary number is a byte containing eight bits.

A **WORD** is a grouping of bits that a computer uses as a standard information format. For example, many systems communicate using a 16 or 32 bit word. Each word for a particular system will conform to a specific format that enables the computer to understand it and decode it's message.

OCTAL NOTATION SYSTEM

The octal number system is based on eight, 0 to 7. The octal notation system is the binary representation of an octal number. Octal notation is comprised of a series of three bit groups (TRIADS). Since the largest decimal number that can be represented by three bits is 7 (111), this is a base eight or octal system.

Octal notation is useful for certain programming techniques where large quantities of binary numbers must be manipulated. Octal is often used for the transmission of data by aircraft computers and their peripherals.

Triad group	4th	3rd	2nd	1st
3 - digit octal notation	001	010	100	001
Decimal equivalent of triad	1	2	4	1
Power of eight	8^3	8^2	8^1	8^0
Decimal value of base eight number	512	64	8	1
Decimal equivalent of octal groups	(1 x 512) 512	(2 x 64) 128	(4 x 8) 32	(1 x 1) 1

Sum the decimal equivalents of each octal group $512 + 128 + 32 + 1 = 673$

Octal notation 001 010 100 001 = decimal 673

HEXADECIMAL NUMBER SYSTEM

The hexadecimal (hex) system uses base 16. The main purpose of this system is to represent the very large numbers of **memory locations** used in micro controllers and microprocessors.

The hexadecimal system uses the **numbers 0 to 9** along with the **letters A to F** to make up the 16 symbols. The table below shows the relationship between hexadecimal, decimal and binary numbers:

Hexadecimal	Decimal	Binary
0	0	0000
1	1	0001
2	2	0010
3	3	0011
4	4	0100
5	5	0101
6	6	0110
7	7	0111
8	8	1000
9	9	1001
A	10	1010
B	11	1011
C	12	1100
D	13	1101
E	14	1110
F	15	1111

An important point to recognise about the hexadecimal system is that 4 binary digits represent a single hexadecimal digit. This is significant because a 16 bit binary code can be represented by a 4 digit hexadecimal number.

DIGITAL COMPUTER COMPONENTS (HARDWARE)

Having discussed the language in which computers work, and remembering that **binary** is the basic language in which calculations are carried out and information is stored in memory, we shall now look at the construction of a basic computer.

All computers have the basic components shown in the diagram below:

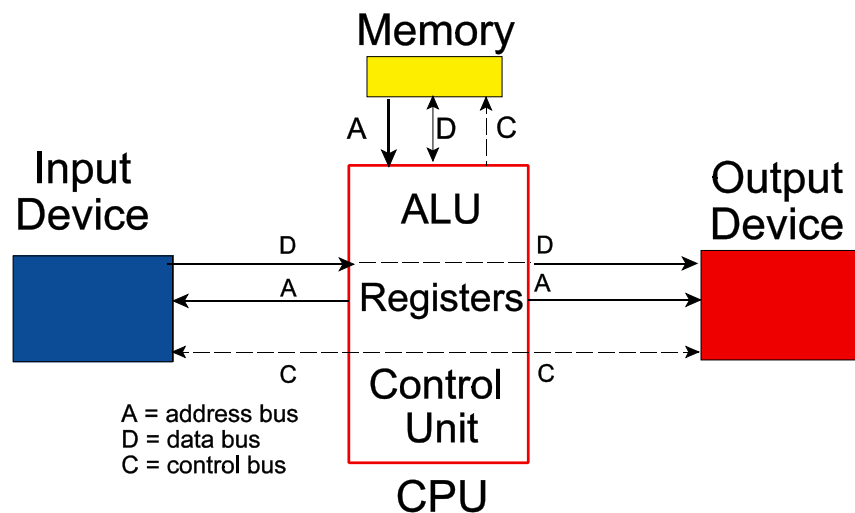

Figure 24.1 A Basic Digital Computer
CENTRAL PROCESSING UNIT (CPU)

The CPU performs, organises and controls all the operations the computer can carry out. It is really the **brain** of the computer. What the CPU can do is controlled by an **instruction set**.

The CPU itself consists of:

- **Arithmetic Logic Unit:** The ALU performs arithmetic calculations and logical operations in the binary number system.
- **Shift Registers:** The shift registers are temporary **stores**; one of them, called the **accumulator** contains the data actually being processed.
- **Control Unit:** The control unit contains the computer's **clock**. This is a crystal controlled oscillator which generates timing pulses at a fixed frequency, typically between 120 and 45MHz. This synchronises computer operations.

INPUT OUTPUT DEVICES

The CPU accepts digital signals from the input devices, keyboard, mouse or modem, in the case of a PC, via its input port. In an aircraft these could be various sensors, Rad Alt, Baro Alt, TAS, fuel flow, etc.

After processing these are fed out via its output port to a Visual Display Unit (Monitor) or printer. In an aircraft the output may be fed to an EFIS Symbol Generator or the FMS Control Display Unit (CDU).

BIOS (Basic Input Output System) converts the input signals to a form the computer can work with and converts the outputs to a form the operator or another aircraft system can understand.

MEMORY

- **Working Memory:** A computer needs a working memory to run the programme of instructions (**software**) it has to execute. If the programme is fixed as in a computer controlled piece of equipment, the memory only has to be **read**. To do this a **Read Only Memory (ROM)** is used. This ROM is programmed by the manufacturer. A **Programmable Read Only Memory (PROM)**, **Erasable Programmable Read Only Memory (EPROM)**, or **Electrically Erasable Programmable Memory (EEPROM)** would be used if the user wanted to construct or modify the programme himself and keep it permanently in the memory.

Memory that retains data when the power is switched off is called **NON VOLATILE MEMORY**. Memory that loses data in the event of a power failure or switch off is called **VOLATILE MEMORY**.

If the programme has to be changed during operation, then the memory must be able to be **written** to as well as **read**. To do this **Random Access Memory (RAM)** this allows instructions to be written in, read out and altered at will. A RAM is also required to store the data for processing as this also will change continually. **RAM is normally Volatile Memory**.

- **Permanent Memory:** As stated above RAM is volatile and work is lost when power is removed. Permanent storage for computer programmes and the work they generate is usually in the form of **magnetic disks**. Both floppy and hard disks are permanent stores of computer data. Their storage capacity is measured in **megabytes or gigabytes**. Hard disks are usually integral parts of the hardware. Floppy disks can be inserted and removed from drives and are transportable and securable.
- **Electrically Alterable Read Only Memory (EAROM):** This is a special type of ROM that can be electronically altered. It is used in the data base of the Flight Management System Computer. This contains a worldwide data base of all airfields, navigation aids, airways, etc. Of course, periodically, frequencies and airways change and the data base needs to be updated.

This is achieved on a 28 day cycle when Jeppesen issue an update floppy disk to their client airlines. The disk is inserted into the FMS Control Display Unit, powered up and the new data inserted and the old data cancelled.

AIRCRAFT SYSTEMS

Systems which are computer controlled include:

- Flight Management System (FMS)
- Digital Flight Guidance System (DFGS)
- Ground Proximity Warning System (GPWS)
- Traffic Alert Collision Avoidance System (TCAS)

Of course Fly by Wire aircraft take computer control very much further, when the whole flight envelope is controlled by computer process with inputs from the crew when necessary.

Current design favours the use of dedicated computers for each separate system. In the future however we may see sharing of computer power in the form of an **Integrated Hazard Warning System (IHWS)**. Here a powerful central processor, with appropriate back up, handles inputs from the stall warning system, windshear detection, GPWS, TCAS and even the Weather Radar, processes the information and prioritises warnings to the crew.

Analogue to Digital Conversion (A to D)

Many aircraft sensors produce analogue information in the form of varying voltages, pressures, temperatures, etc. Of course digital computers use digital (binary) information and a device called an **Analogue to Digital Converter** is required in the interface between the sensor and the computer input device.

Digital to Analogue Conversion (D to A)

When a digital computer has to pass information to an analogue device the process is reversed and a **Digital to Analogue Converter** is used.

QUESTIONS

1. A basic digital computer consists of:
 1. input peripherals
 2. central processing unit
 3. inertial unit
 4. memory
 5. auto brightness control
 6. output peripherals
 - a. 1, 2, 3, 4 and 6
 - b. 1, 2, 4 and 6
 - c. 1, 4, 6 only
 - d. 2, 3, 4 and 6

2. The Central Processing Unit (CPU) consists of:
 1. input device
 2. output device
 3. Arithmetic Logic Unit (ALU)
 4. Shift Registers
 5. Control Unit
 6. Hard disk
 - a. 1, 2, 3 and 5
 - b. 3, 4, and 6
 - c. 1, 2, 5, and 6
 - d. 3, 4 and 5

3. In computer terminology an input peripheral device would be:
 - a. a hard disk
 - b. a floppy disk
 - c. a keyboard
 - d. a screen display unit

4. The two types of binary logic are:
 - a. positive and negative
 - b. variable and negative
 - c. positive and reversible
 - d. variable and reversible

5. In computer terminology an output peripheral device would be:
 - a. a floppy disk
 - b. a hard disk
 - c. a screen display unit
 - d. a keyboard

6. In computer terminology a memory which loses its data when power is removed is called:
- non-volatile
 - non-permanent
 - non-retentive
 - volatile
7. In computer terminology a memory which retains its data when power is removed is called:
- non-volatile
 - volatile
 - RAM
 - ROM
8. Examples of input peripheral devices are:
- mouse
 - modem
 - printer
 - screen display unit
 - keyboard
- 2, 3, 4 and 5
 - 1, 2 and 5
 - 1 and 5
 - 1, 2, 3
9. In computer terminology “software” refers to:
- the memory system floppy disks, hard disks, etc
 - the RAM and ROM capacity
 - the programme of instructions
 - the BIOS
10. In computer terminology “hardware” refers to:
- the digital computer components, keyboard, monitor, CPU, etc
 - the permanent memory system and its capacity
 - the RAM capacity
 - the programme of instructions
11. Memory capacity in a digital computer is expressed in:
- Bits (Mbits, Gbits)
 - Bytes (Mbytes, Gbytes)
 - ROM capacity
 - RAM capacity
12. The smallest information element in a digital system is:
- byte
 - digit
 - electron
 - bit

13. A group of binary digits handled as a group is referred to as a:
 - a. byte
 - b. mega bit
 - c. giga bit
 - d. bits

14. Convert the decimal number 7 to its binary equivalent:
 - a. 1110
 - b. 111
 - c. 1101
 - d. 100

15. Convert binary 1110 to its decimal equivalent:
 - a. 13
 - b. 14
 - c. 15
 - d. 16

16. The computer language in which calculations are carried out and information is stored in memory is:
 - a. decimal
 - b. hexadecimal
 - c. octal
 - d. binary

17. The computer language system which uses the base 16 is known as:
 - a. septagesimal
 - b. hectadecimal
 - c. hexadecimal
 - d. octal

18. The computer language system which uses the base 8 is called:
 - a. decimal
 - b. binary
 - c. octal
 - d. hexadecimal

19. The number system which uses the numbers 0 to 9 followed by the letters A to F is:
 - a. alpha numeric
 - b. hexadecimal
 - c. octal
 - d. numeric alpha

20. In a digital computer binary 1 is represented by +5 volts and Binary 0 by earth. This is an example of:
- negative logic
 - bipolar logic
 - positive logic
 - analog system
21. In a negative logic system:
- binary 1 is a low level, binary 0 is a high level
 - binary 1 is a high level, binary 0 is a low level
 - binary 1 is positive, binary 0 is negative
 - binary 1 and binary 0 are equal levels above and below zero
22. The permanent memory of a digital computer usually takes the form of:
- Integrated circuits rated in megabytes
 - shift registers whose capacity is rated in mega or gigabytes
 - floppy or hard disks whose capacity is measured in mega or gigabytes
 - Central Processing Unit
23. The purpose of the Arithmetic Logic Unit within the Central Processing Unit is to:
- act as a temporary store for information being processed
 - perform calculations in the binary number system
 - perform calculations in the binary, octal or hexadecimal system
 - perform all clock functions based on the computer clock frequency (clock time)
24. Within the Central Processing Unit, the temporary stores and accumulator which handle the data during processing are called:
- Arithmetic Logic Unit (ALU)
 - Shift Registers
 - Control Unit
 - BIOS
25. Aircraft data in analog form, before being processed by a computer must be passed through a:
- digital to analog converter (D to A)
 - EPROM
 - EAROM
 - analog to digital converter (A to D)

ANSWERS

1	B	11	B	21	A
2	D	12	D	22	C
3	C	13	A	23	B
4	A	14	B	24	B
5	C	15	B	25	D
6	D	16	D		
7	A	17	C		
8	B	18	C		
9	C	19	B		
10	A	20	C		

CHAPTER TWENTY FIVE

COMMUNICATIONS AND THE FUTURE AIR NAVIGATION SYSTEMS

Contents

INTRODUCTION343
COMMUNICATIONS SYSTEMS343
AIRCRAFT COMMUNICATION ADDRESSING and REPORTING SYSTEM (ACARS).344
VHF DATALINK (VDL)344
LOGON344
CPDLC.345
FUTURE AIR NAVIGATION SYSTEMS (FANS)347
FANS A/1347
FANS B/2348

INTRODUCTION

Currently aircraft are controlled using voice communications. Over and close to populated landmasses; ATC use radar to provide positive control of aircraft with VHF communications. However over oceans, deserts and polar regions radar is not available and ATC provide a procedural control service which generally requires HF communications and high vertical, lateral and longitudinal separation distances, resulting in a low traffic density.

Aircraft operating in the same direction across the North Atlantic in MNPS and RVSM airspace are given lateral separation of 60 nm, longitudinal separation of 10 minutes (which means a separation of between about 60 and 100 nm) and vertical separation of 2000 ft. In non-MNPS/RVSM airspace the minima are 120 nm, 15 minutes and 4000 ft respectively. Position reports are passed by aircraft crossing the North Atlantic every 10° of longitude up to 70°N and every 20° north thereof, which means ATC receive a position update every 30 – 60 minutes. With the increase in international air traffic this is posing major limitations, compounded by the difficulties associated with HF communications which means that in these remote areas the pilot is rarely communicating directly with the ATC controller but rather through a third party who relays messages between the two.

Over and around populated areas primary radar and SSR mode S allow positive identification and control of aircraft. Area navigation systems (RNAV) permit better utilisation of the airspace since aircraft are no longer constrained to flying between VOR/DME beacons. The combination of these facilitates an increase in capacity and a reduction in the level of communications. However, this is a small percentage of the airspace being used for international air travel. Inertial reference systems (IRS) are used to determine aircraft positions in remote areas, but these are subject to errors, which can increase to as much as 10 nm during transoceanic flight. The need to increase capacity over the rest of the world requires that ATC have real time information on the aircraft positions, which must have improved accuracy, and better communications between the air traffic controller and the pilot.

The advances in technology mean we now have global satellite navigation systems (GNSS) providing position accuracy to better than one nm. Although there are still some issues on the service provided by GNSS, in general this high level of position accuracy is now globally achievable. Satellite communication systems (SATCOM) are also available giving the potential for global communications through a single medium. Furthermore, datalink systems are already reducing the need for the high level of voice communications traditionally required.

COMMUNICATIONS SYSTEMS

Until the late 1980s communications with ATC and the air operators was only achievable using VHF and HF voice communications. VHF communications are line of sight and therefore only available over and in the near vicinity of habitable areas and are limited to about 200nm from the transmitter for aircraft at FL300. Outside these areas communications have to be effected using HF. HF is notoriously difficult to use, having high levels of static interference with fading of signals which leads to messages being repeated and/or relayed through other aircraft. This means that a third party communicates with the aircraft and relays messages between the ATC controller and the pilot. Because of the stressful nature of these communications, the pilot does not maintain a continuous listening watch but is alerted by a selective calling system (SELCAL) which is activated by the communicator when there is a message for the aircraft.

In the 1990s voice communications were extended to SATCOM (using UHF L-band frequencies) via geostationary satellites. Because geostationary satellites can only be positioned above the equator at an altitude of 35800 km coverage is limited to about 80° of latitude. To provide a service in polar regions it is intended to use satellites in lower altitude orbits with the orbits inclined such that polar regions will have a full SATCOM service.

AIRCRAFT COMMUNICATION ADDRESSING and REPORTING SYSTEM (ACARS)

Voice communications are prone to human fallibility with the potential for errors being made both by pilots and ATC controllers in the recording of messages. In order to improve the integrity of message handling and reduce the volume of voice communications ACARS came into operational use in the late 1980s. ACARS uses datalink in telex format to pass messages between the aircraft and ATC or aircraft operating companies at the relatively slow rate of 2.4 kbps using VHF and the messages were printed out in the cockpit. In the early 1990s this service was extended to SATCOM for flights outside VHF coverage using geostationary satellites. The gap in polar regions was closed in 2001 by extending the service to HF.

In the 1990s interfaces with the FMS were developed which allowed operational data, for example meteorological information and alternate flight plan routes, to be evaluated using the FMS. Maintenance functions were also added to allow independent monitoring of the aircraft systems. This is implemented through ATSU/DCDU (digital cockpit display unit).

VHF DATALINK (VDL)

ACARS is gradually being replaced with VDL mode 2 which provides a digital link at a rate of 31.5 kbps, giving more than 10 times the capacity of ACARS. VDL mode 2 requires specific address for an aircraft and the unique mode S address will be used. This type of digital system is known as controller pilot datalink communications (CPDLC)

VDL mode 2 is the part of the new digital aeronautical telecommunications network (ATN) which links ATC facilities and aircraft operational control (AOC) with the aircraft.

LOGON

To gain access to the VDL service the pilot must perform a manual logon this requires the pilot to input the four digit ICAO address for the ATSU into the FMS which then sends the logon message to the ATSU. The logon message includes the aircraft address and information on the services the aircraft equipment supports. The ATSU acknowledges the logon message then sends a connection request message to the aircraft the aircraft responds with a connection confirm message and the process is complete. This known as the ATS facilities notification (AFN)

This initial logon is performed on first contact with the ATSU on the ground, when entering an area with CPDLC from a non-CPDLC area and if there has been any interruption to the service (that is if the link is broken). Once the service is established the equipment will perform an automatic transfer to subsequent CPDLC capable ATSUs.

The message from the aircraft to the ATSU is always referred to as the downlink (DL) message, and from the ATSU to the aircraft as the uplink (UL) message even if the aircraft is on the ground.

CPDLC

CPDLC permits datalink messages to be generated for all stages of flight. The messages have a fixed format defined within the FMS and ATSU computers and are activated by the ATC controller or pilot either as an instruction or response to a request. The messages are annotated according to whether a response is required or not. For example if the pilot is instructed to report levelling at FL310 then the message will remain open until the aircraft reaches FL310 when the FMS will send the response. The confirmation that the aircraft is at FL310 does not require a response from the controller, so the message will automatically close one received at the ground station.

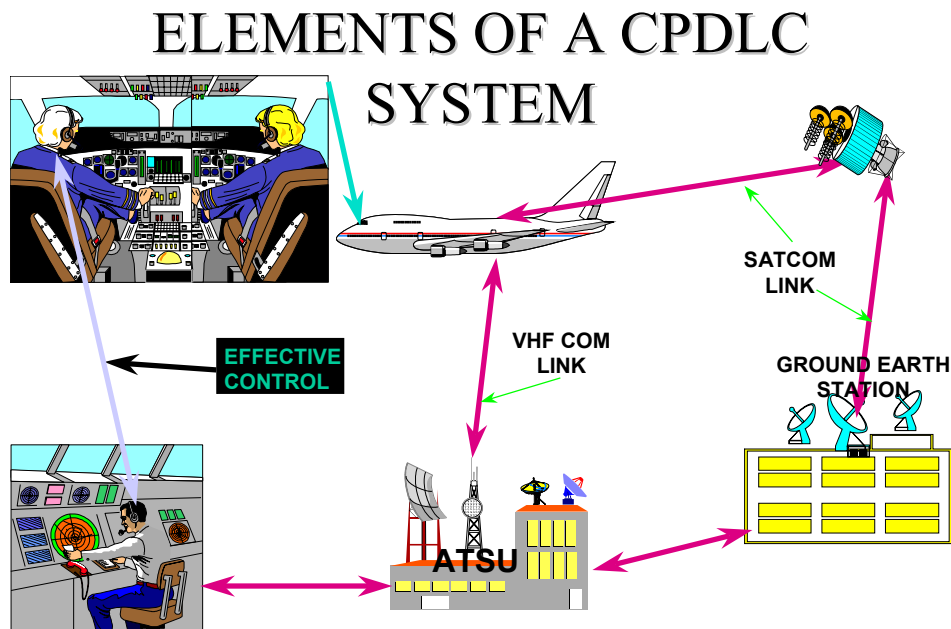

The message formats available cover all aspects of pre-departure clearance (PDC), taxi instructions, takeoff, climb, en-route, descent and landing. Additionally, there is provision for emergency and safety messages. Should either the ATC controller or the pilot need to communicate a non-standard message then this can be achieved through normal voice communication circuits.

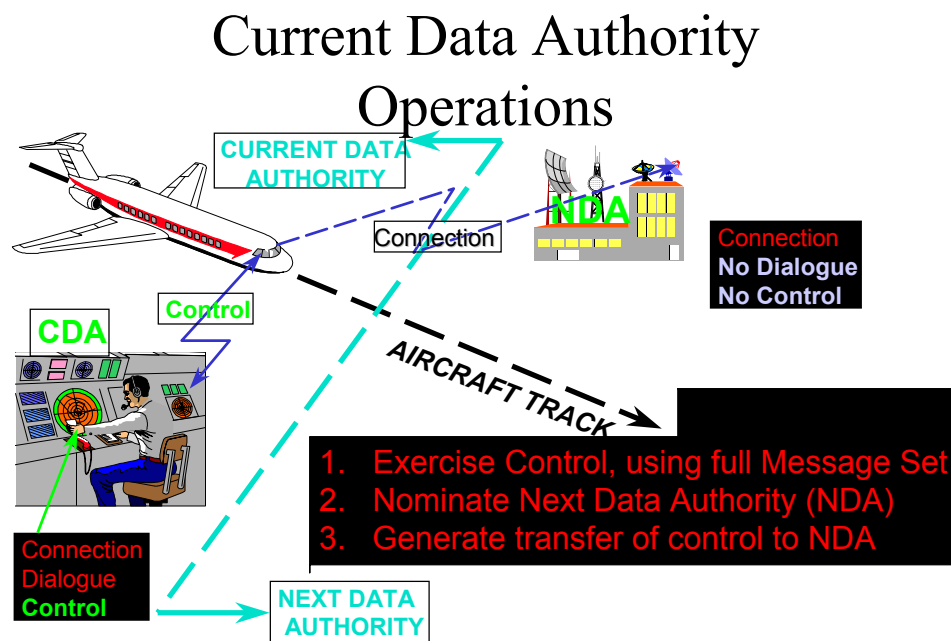

Air Traffic Management (ATM)

ATM will be implemented through the digital aeronautical telecommunications network (ATN), VDL mode 2 for land areas and SATCOM for remote areas, with either VHF or SATCOM for voice communications.

Other Digital Services

ATIS is being digitised (D-ATIS) to provide either a print out in the cockpit or input to the FMS for display on the MCDU. VOLMET and pre-departure clearance (PDC) messages are also being digitised. Here are some examples of the message formats:

Digital ATIS Printout in Cockpit

```
/HKGATYA.TI2/VHHH ARR ATIS Z
2205Z
HONG KONG ATIS
RWY IN USE 07R
EXPECT ILS DME APCH
WIND LIGHT AND VARIABLE
VIS 10 KM
CLOUD FEW 1600FT
TEMP 28 DP 22 QNH 1007
ACK Z ON FREQ 119.1 FOR ARR AND 129.9 FOR DEP
```

Digital VOLMET Printout in Cockpit

/HKGVOYA.TI2/VHHH ENR ATIS
HONG KONG VOLMET
VHHK SIGMET A2 VALID 090530/090930 VHHHHONG
KONG CTA EMBD TS FCST S OF N19 E OF E114 TOP FL 350 STNR NC =
METAR VHHH 090730Z 16011KT 130V190 9999 SCT028 BKN300 33/23 Q1007 NOSIG=
METAR ZGGG 090700Z 13004MPS 9999 FEW040TCU FEW040 34/23 Q1007 NOSIG=
METAR ROAH 090730Z 19013KT 9999 FEW015 32/25 Q1010=
METAR RCTP 090730Z 28012KT 9999 SCT012 FEW020CB BKN022 BKN050 30/27 Q1009
TEMPO 3000 -SHRA=
METAR RCKH 090730Z 18017KT 9999 FEW020 SCT300 33/23 Q1007 NOSIG=
METAR RPLL 090700Z 14008KT 9999 SCT025 SCT100 31/18 Q1008 TCU W=
METAR RPVM 090700Z 24014KT 9999 FEW020 SCT300 31/26 Q1007 A2976=
TAF VHHH 090530Z 090615 18010KT 9999

PDC Printout in Cockpit

PDC 130044
CPA065 B742 VHHH 0100
CLEARED TO OMDB VIA
07R
LAKE 1A DEPARTURE V1
ROUTE:FLIGHT PLAN ROUTE
MAINTAIN:5000FT
EXPECT:F330
SQUAWK A5156
— END

FUTURE AIR NAVIGATION SYSTEMS (FANS)

The aim of FANS is to provide an integrated air traffic control system in areas where radar is not available by using GNSS to define aircraft position with datalink and voice communications through geostationary and lower orbit satellites providing global coverage to ATC centres. This will provide ATC with continuous information on the aircraft positions and direct pilot to controller communications. When in operation this will allow separation distances to be significantly reduced, and if position accuracy is degraded for any reason, the aircraft still have TCAS to warn of any potential conflict.

FANS A/1

FANS has been under development since about 1990 by Airbus (FANS/A) and Boeing (FANS/1). FANS A/1 provides a communications, navigation and surveillance (CNS) system and an automatic dependent surveillance system (ADS). Communications utilise current frequency allocations in HF, VHF and L-band and GNSS provide the navigation input for the surveillance. Currently it is used by some AOCs to monitor the progress of aircraft at all stages of flight. So, for example, the aircraft system will automatically inform the AOC of gate departure, take-off, landing and gate arrival. In flight progress and the operation of on board systems can also be monitored and, where necessary, messages can be passed to alert/assist the crew when potential problems are detected. FANS A has been in use over the North Atlantic since 2002 by some operators for waypoint position reporting (WPR) using VHF or SATCOM

The typical architecture is shown in the next diagram:

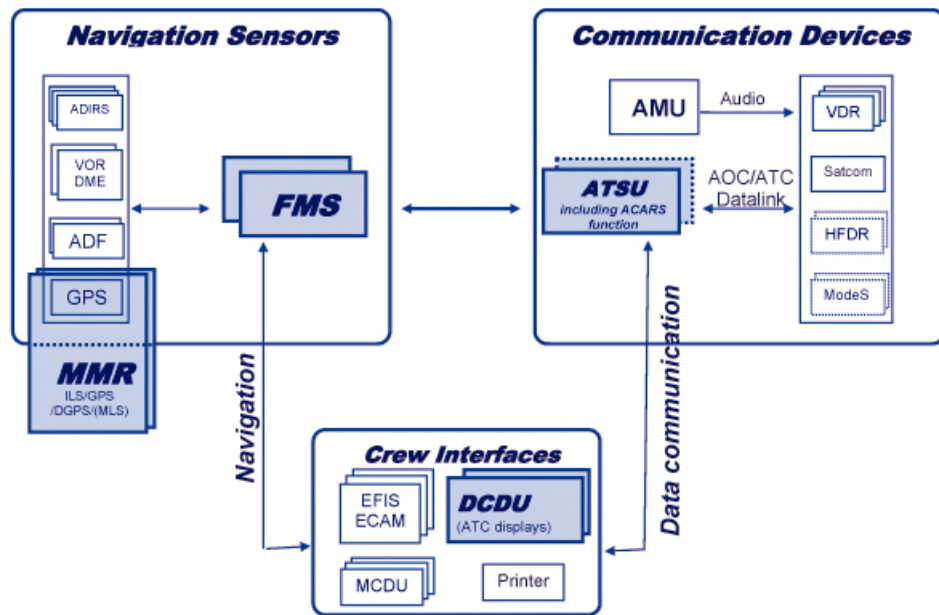

The diagram shows a typical DCDU message display:

FANS B/2

FANS B/2 extends the VDL type service to areas outwith VHF coverage. The principle is the CNS/ADS. Aircraft position is defined using GNSS and automatically reported to the ATSU. Messages to/from aircraft are effected using datalink. SATCOM voice communications will only be used for emergency or non-standard communications.

ATPL GROUND TRAINING SERIES

Aircraft General Knowledge 4



Automatic Flight and Control Systems

CHAPTER TWENTY SIX
FLIGHT DIRECTOR SYSTEMS

Contents

GLOSSARY353
INTRODUCTION355
FLIGHT DIRECTOR SYSTEM COMPONENTS356
FLIGHT DIRECTOR MODES.360
NAVIGATION MODES363
DUAL FDS365

GLOSSARY

A/P	Autopilot
A/T	Auto-Throttle
A/L	Auto-Land
ADC	Air Data Computer
ADI (EADI)	Attitude and Direction Indicator (Electronic)
AFCP	Auto-Flight Control Panel (see also MCP)
AFCs	Auto-Flight Control System
AFDS	Auto-Flight Director System
AFS	Auto-Flight System
ALT ACQ	Altitude Acquire (mode)
AoA	Angle Of Attack
APP	Approach (mode)
CADC	Central Air Data Computer
CDI (bar)	Course Deviation Indicator (bar)
CDU	Control and Display Unit
CMD	Command (or Autopilot Engage)
CWS	Control Wheel Steering
DG / DI	Directional Gyro / Direction Indicator
ECAM	Electronic Centralised Aircraft Monitoring
EFIS	Electronic Flight Instrumentation System
EICAS	Engine Instruments and Crew Alerting System
EPR	Engine Pressure Ratio
FADEC	Full Authority Digital Engine Control
FCC	Flight Control Computer
FD	Flight Director
FDC	Flight Director Computer FDS Flight Director System
FMA	Flight Mode Annunciator
FMC	Flight Management Computer
FMGS	Flight Management and Guidance System
G/S	Glideslope or groundspeed dependant on context
GA	Go Around or Gear Altitude dependant on context
HDG	Heading (mode)
HSI (EHSI)	Horizontal Situation Indicator (Electronic)
INS	Inertial Navigation System
IRS	Inertial Reference System
LAND 2	Fail Passive
LAND 3	Fail Active
LNAV	Lateral NAVigation (mode)
LOC	Localiser (mode)
LVL CHG	Level Change (mode)
MCP	Mode Control Panel (see also AFCP)
MI	Magnetic Indicator

N1	RPM of the first stage of compression (normally the fan in a high bypass engine) expressed as a percentage
ND	Navigational Display
PFCU	Powered Flying Control Unit
PFD	Primary Flight Display (EADI including speed, altitude, VSI tapes and commonly a compass and annunciator panel)
PMC	Power Management Computer
QDM	“Q” code for a magnetic heading to fly assuming zero wind
RA	Radio Altitude
SPD	Speed (mode)
TCS	Touch Control Steering
TLA	Thrust
TMA	Thrust Mode Annunciator
TMS	Thrust Management System
TO/GA	Take Off / Go Around
TRK	Track
V/S	Vertical Speed (mode)
VG	Vertical Gyro
VNAV (SPD/PTH)	Vertical NAVigation /Path or Speed (mode)
VOR	VOR tracking (mode) or a VHF omni-range beacon dependant on context

INTRODUCTION

The Flight Director System (FDS) was originally developed as an aid used by the pilot during landing. It gave a pilot the ability to concentrate on fewer instruments and, as it gave instructions as to attitude and steering, it reduced the workload on the pilot. As autopilots became more advanced the signals produced by the FDS could be coupled to the autopilot allowing it to perform more complex tasks.

With a FDS, information about the attitude, heading and flight-path of an aircraft, can be integrated with navigation information to produce either easy to interpret visual instructions for the pilot and / or input to the autopilot, or both.

To bring the terminology of FDS and autopilot together it is usual to describe the FDS as having 2 “channels”. The first channel is the **roll channel**, the second is the **pitch channel**. You will learn more about channels in the autopilot section.

Information for the FDS can come from several possible sources:

- Pitot-Static system or Air Data Computer (ADC).
- VHF Nav receiver allowing input from VOR beacons or ILS.
- Flight Management System, Inertial Navigation / Reference System.

The FDS also requires attitude and directional information. On older, electro-mechanical systems this would come from the Gyro Magnetic Compass and a Vertical Gyro System. More modern aircraft use Inertial Navigation/Reference System (INS / IRS) information in place of a vertical gyro and will be able to feed the navigation data from these systems into the FDS / Autopilot combination.

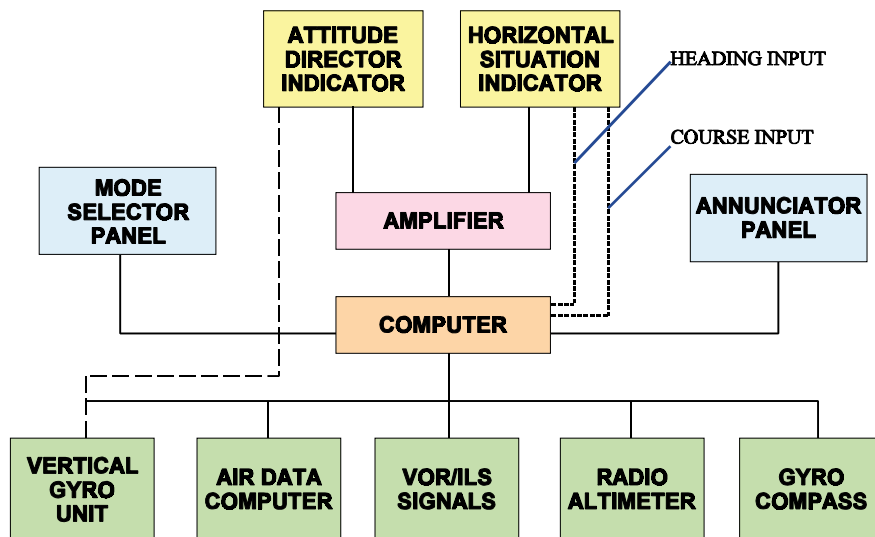

Fig 1.1 A “typical” electro-mechanical Flight Director System

FLIGHT DIRECTOR SYSTEM COMPONENTS

There follows a description of a “typical modern” FDS:

Electronic Attitude Director Indicator (EADI)

This is a fairly standard artificial horizon providing pitch and roll information and gives the Attitude to the name of the instrument. The Director part comes from the instruments ability to display demand information from the Flight director system using Flight Director Command Bars. These come in 2 main forms as shown below:

Both of the indications for these apparently different displays are intuitive and essentially the same in that the pilot is required to “fly to” either the point where the “wires” cross, or the point between the wedges, in order to satisfy the demand from the FDS.

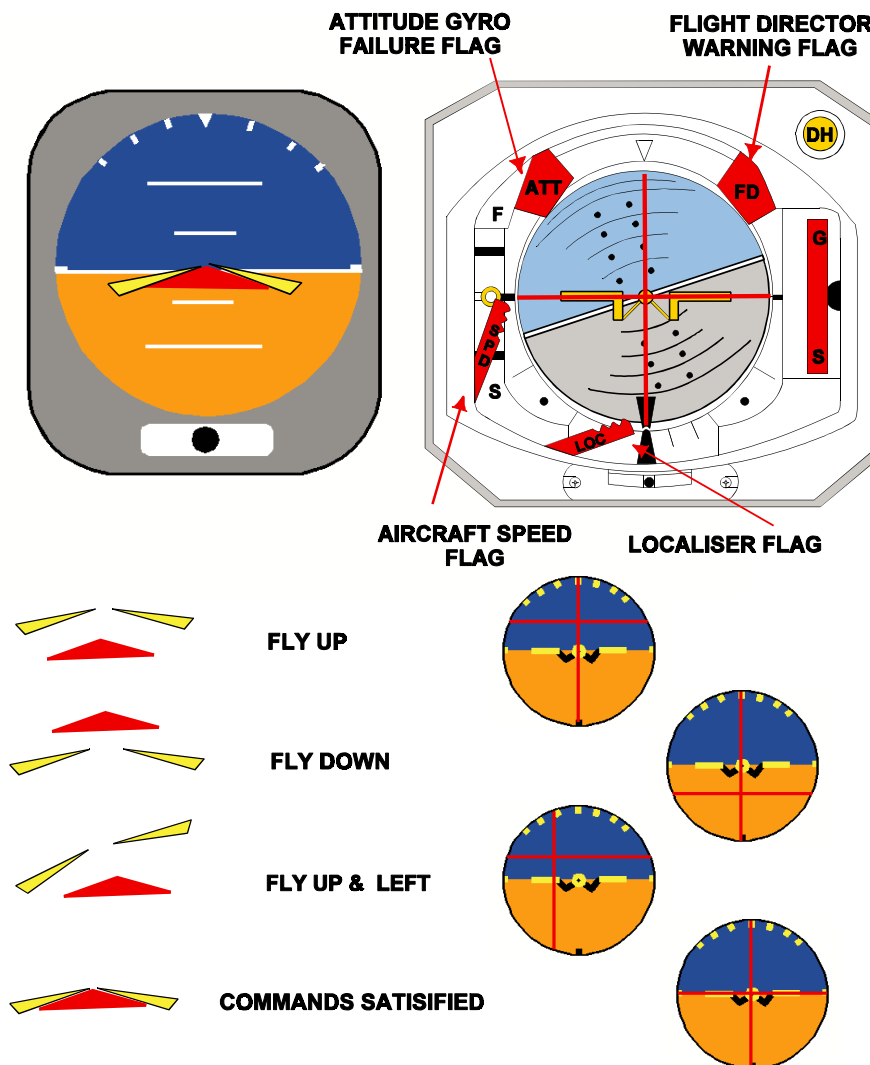

Primary Flight Display (PFD)

The PFD is part of an EFIS (Electronic Flight Instrument System) display and brings all of the information required to fly the aircraft onto one display. It has an EADI normally surrounded by speed, altitude, and vertical speed tapes and often a compass display incorporating some minimal navigation information. It also has an area which is used for annunciating flight director, autopilot and auto-throttle modes and status.



Electronic Horizontal Situation Indicator (EHSI)

You may already be familiar with the Gyro Magnetic Compass. An HSI is a gyro magnetic compass display with a Course Deviation Indicator (CDI bar), a series of dots representing deviation in degrees (the scale varies with the type of display) a from / to pointer, a selected course window and a DME display of range. A heading bug is also included. In older systems the course selection is done directly on the HSI using an attached knob. The system we will refer to uses a remote centralised FD mode control and AP panel called the Autoflight Mode Control Panel (AMCP or simply MCP). The system we will be referring to also uses a Navigational Display (ND). This, like the PFD, is a more flexible display but is able to show “classical” representations of an HSI.

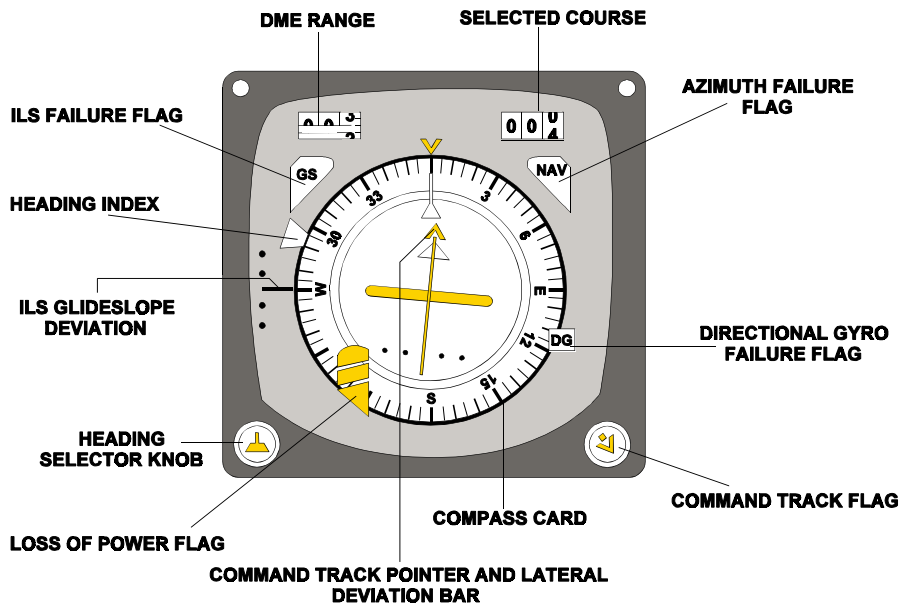

HSI Display



EHSI

Flight Director Computer (FDC)

This is where all the information is gathered and processed. On older aircraft this information could be in the form of analogue outputs from the ADC and VG. Current systems will be purely digital. Older aircraft that have been refitted may have analogue inputs to a digital converter so that modern displays and autopilot systems can be used. Outputs from here are sent to the symbol generators for the EADI / EHSI and /or the autopilot as required.

Optional Components

FDS use other components depending on what generation they belong to:

Instrument Amplifier or Symbol Generator

Where information is required to be displayed on electro-mechanical instruments the signals require amplification to drive the associated motors. On EFIS fitted aircraft the FDC output can be fed directly to the symbol generators for the Primary Flight Display (PFD) and Navigational Display (ND) units.

Vertical Gyro or INS / IRS

In older or smaller aircraft types, normally without any INS / IRS, reference to the vertical for the Artificial Horizon part of the ADI is provided by a remote Vertical Gyro system. This simply means that the gyro that acts as the artificial horizon is not contained in the instrument in the panel in front of the pilot but can be any where on the aircraft (normally near the C of G). The information derived from it is fed to motors that drive the display of the ADI. The benefits of this system are that the gyro can be near the aircraft's C of G and therefore provide a more accurate display of the attitude of the aircraft, and this data, in electrical form can be fed to any other items requiring attitude information e.g. the Autopilot.

More modern and larger aircraft may use data from their INS or IRS to replace that normally provided by a VG as the INS is simply a more modern and much more sensitive version of a gyro.

Mode Controllers or Mode Control Panel (MCP)

The mode controller allows the pilot to change the mode of the FDS, alter the pitch trim and switch the FDS display on or off as required. Obviously on a visual approach it would be unnecessary to display the FD command bars and could clutter up the display at a critical phase of flight. The modes available depend on the fit of the aircraft. On modern aircraft the MCP, on which most of the information for the autopilot is programmed is used to replace the separate FD mode controller. Typical modes and the pitch trim will be discussed a little later. The MCP will also be described in more detail later.

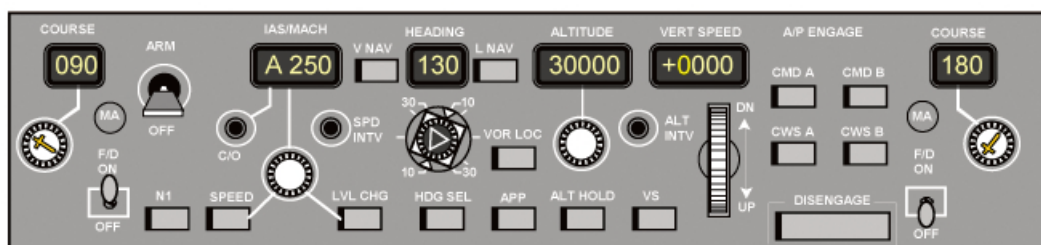

Mode Annunciators / Indicators or PFD Flight Mode Annunciators (FMA)

These are a series of simple lights, magnetic indicators or a small panel of illuminated indicators that **show the pilot what mode or phase of a particular mode that the FDS / Autopilot is in.** In more basic systems the most common indications are during an ILS approach. These panels are usually only powered with the FD switch on.

When the aircraft is awaiting capture of the localiser, the LOC (localiser) light will typically be amber. When the localiser has been captured the light will change to a green LOC light. Approaching the glide-slope the GS light will be Amber and again will change to green to indicate the fact that the FDS has locked on to the GS.

More capable systems will have more functions and consequently more lights, such as those indicating the state of the auto-throttle and flare or Go Around modes.

EFIS equipped aircraft display the appropriate information on the PFD/EADI in an area called the Flight Mode Annunciator. As the same space can be used for all the different messages, it can be kept small. Here all the modes for the FD auto-throttle and autopilot are displayed. Newly changed information is often emphasised on the FMA type display by surrounding it in a box.

FLIGHT DIRECTOR MODES

As has been said the modes for each system vary. The modes described now are the most common but not all may be available depending on aircraft fit.

First it must be appreciated that there is a distinction in the way data displayed to the pilot. The glideslope indicator to the side of the ADI and the CDI bar are what is termed **Raw information.** That is the information is not processed in any way and simply indicates that the aircraft is left or right of track / localiser, or above or below the glideslope and knowledge of the system will tell you by how many degrees.

In order to anticipate turns, climbs and descents for smooth flying the FDS can use the raw data, compute and signal commands to either the pilot via the Flight Director bars or directly to the autopilot. This is called **computed information** and is derived from the **rate of change of deviation** of the incoming signal. As the rate of change of deviation from the desired track increases, the FDS computes that in order to intercept the track correctly, rather than fly straight through, it must indicate a turn onto track.

This becomes important if the FDS fails as although the computed information will no longer be reliable / available, the raw information may still be available and used.

Many of the FD modes are common with the autopilot modes. We have detailed the FD modes in the following sections. Where they are similar to the autopilot mode the description is fairly basic with the full description being found in the autopilot chapter. Where the FD mode differs from the autopilot mode the description will detail the differences.

FD Fail indications

Before going on to discuss the modes individually we need to know how the FDS informs us if the information it is giving is reliable. On electro-mechanical displays warning flags are used. If the vertical gyro or other vertical referencing system fails or its power supply fails then a "Gyro" warning flag will pop into view, normally on the ADI. Failures of the FDC, the instrument amplifier, or the ADI itself, are indicated by a flag labelled either "ATT" for attitude or "FD". This will normally again be in the ADI display.

If glideslope information is unreliable, due to poor signal strength or failure of the system, a “GS” flag will appear in front of the raw glideslope scale where it appears, either to the side of the ADI or the HSI.

Poor reception, unreliable or loss of VOR, LNAV or LOC information is indicated by a “NAV” flag, normally located on the HSI.

The HSI will have a power failure flag to indicate loss of power to the instrument or the compass gyro. It will also indicate if the compass system is operating in Directional Gyro (DG) mode i.e. the magnetic reference has been lost and the compass is now essentially a DI.

Command attitude changes

When flying level the pilot selects an attitude that, for the given airspeed, will achieve level flight. With the aircraft at low airspeed the pitch angle will be several degrees nose up to avoid descending. As an aid to keeping a constant pitch angle the FD command bars can be offset vertically to provide an intuitive aiming point for the pilot.

This can also be used for keeping constant pitch angles for climbing and descending. The movement of the bars is achieved by moving the Pitch Trim knob or wheel (dependent on age of design) until the command bars are in the desired position. The pitch trim system is inhibited whenever any other pitch mode is active.

Flight Director Takeoff Mode

Initially both flight director systems should be switched on prior to starting the takeoff roll. The FD takeoff mode is engaged by pressing either of the TO/GA switches on the throttles. The AFDS annunciation is “TO/GA”. The initial FD commands are for 10 degrees nose-down pitch and wings level. At 60 kts IAS, the FD command changes to 15 degrees nose-up and wings level.

To engage the FD system during the takeoff even if the FD switches are off press the TO/GA button after 80 kts IAS but before 2000’ or 150 seconds after lift-off and the command bars will automatically disappear.

The FD provides pitch commands after lift-off. It continues to command 15 degrees nose-up pitch until sufficient climb rate is achieved. It then commands pitch to maintain the MCP speed plus 20 kts IAS; this speed is calculated and set during the pre-flight. Next, when either autopilot is engaged or when the MCP speed selector is rotated 20 kts IAS is added automatically to the MCP IAS display.

FD roll commands wings level from takeoff mode engagement through to the takeoff climb-out. To terminate the takeoff mode below 400’ RA, both of the FD switches must be turned off. Above 400’ RA, the takeoff mode can be terminated by selecting other FD pitch modes or by engaging an autopilot.

Engaging an autopilot after a FD takeoff, automatically engages the autopilot and FD in LVL CHG (level change) for pitch and HDG SEL (heading select) for roll. If the FD mode had been changed from TO/GA to LNAV, HDG SEL or VOR/LOC, the autopilot initially engages in the same roll mode as the FD’s. When LVL CHG engages, the MCP IAS/MACH display and airspeed cursors change to $V_2 + 20$ kts.

If an engine fails during takeoff before reaching V_2 speed, the FD pitch commands are referenced to V_2 . If the engine failure occurs after reaching V_2 , but less than $V_2 + 20$ kts, the reference speed is that at which the engine failure occurred. If the failure occurs at or above $V_2 + 20$ kts, $V_2 + 20$ kts is the commanded speed. Reference speed is never less than V_2 for the current flap setting. Roll control remains the same as for all engines operating.

1. Aircraft on the ground.
2. F/D mode selector to HGD mode (typical outbound heading).
3. Pitch command knob to desired climb attitude.
4. Command bar moves up.
5. Pilot pitches aircraft up to centre FD bars on aircraft symbol.
6. After aircraft gets to desired altitude and levels, bar deflects up. Recentre by turning pitch command knob until bars are centred on aircraft symbol.

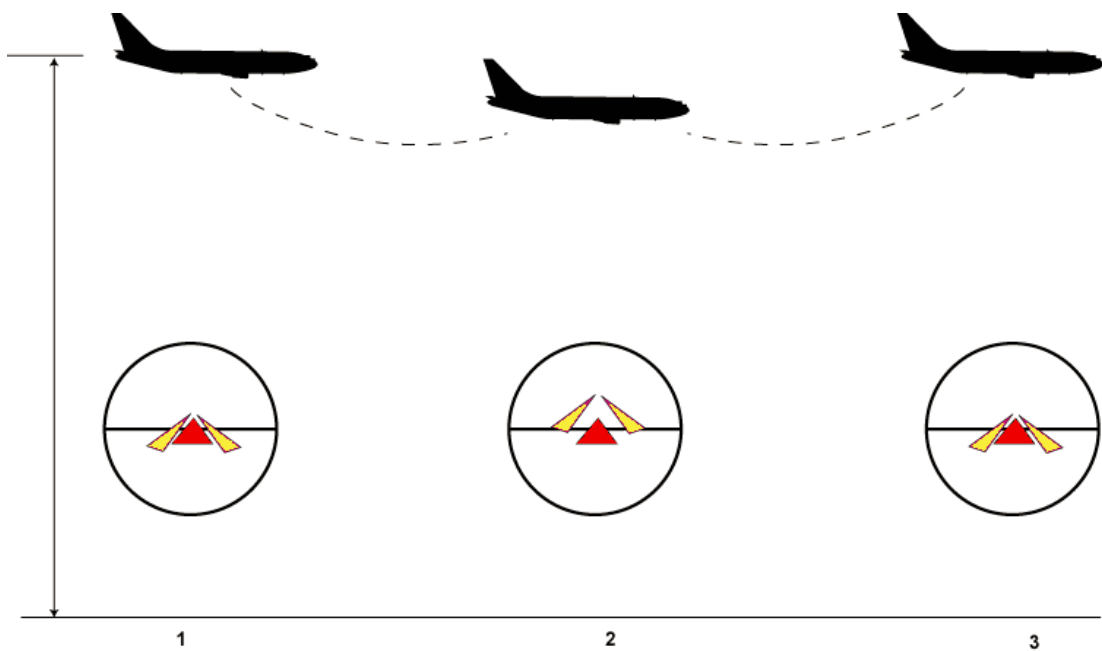
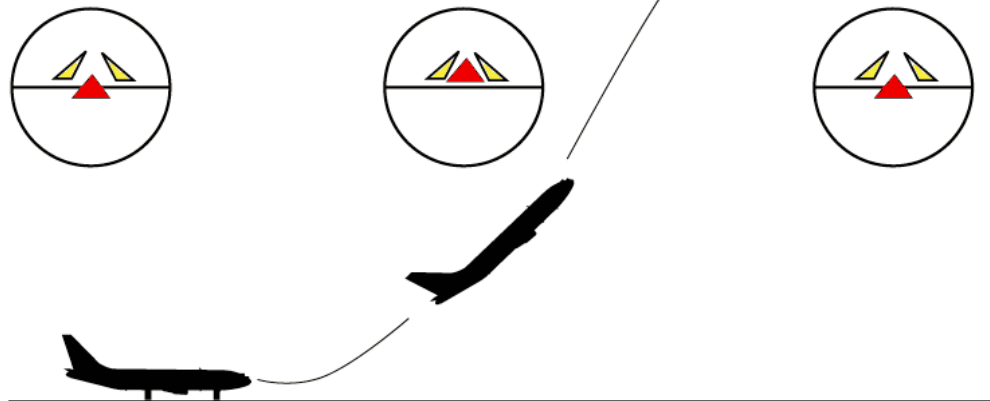

Altitude Acquire / Altitude Hold

In the cruise we require to fly at a constant level. The FDS can be used to help achieve this. Signals from the ADC through the FDS mean that when we are at the selected level, the FD command bars indicate a neutral position. If the aircraft were to deviate above the desired altitude the command bars would indicate a pitch down command and visa versa.

NAVIGATION MODES

Heading Mode

In this mode VOR beacons and various internal navigation systems can be linked to either display information using the FDS or linked to the autopilot or both.

The simplest nav mode is to have the aircraft keep flying in the direction you select. This is called **Heading Mode**. In this mode the pilot selects a desired heading, either using a knob on the HSI, using the central FDS / autopilot panel or on the MCP. The FDS will now indicate a fly to command to bring the aircraft on to the desired heading.

LOC/ VOR (LNAV)

This selection allows VOR, Localizer or INS/IRS/FMS(GPS) nav information to be fed and displayed on the FDS. In the case of the VOR, after tuning and correctly identifying the station to be used, with VOR / LOC selected on the mode selector and the desired track to (or from) the beacon set in the course selection widow (using either on the HSI, MCP or the CDU), the FDS will give appropriate steering command to intercept and then maintain track.

Intercepting the LOC is very similar but will be discussed in more detail later.

With aircraft being fitted with more accurate navigation systems it is only logical that this information should be made available to the pilot and autopilot. INS / IRS / FMS / GPS information can be selected for display in very much the same way as the VOR information and is represented in the same way.

Note that because the actual track of the aircraft is being compared with the desired track, and the flight director commands are given to fly the desired track, the flight director system will effectively compensate for drift. There is no need for wind velocity information (although the INS could provide it), it is purely an effect of the flight director giving commands to fly the desired course/track selected.

Flight Director Approaches (FDA)

The ILS frequency is tuned into the VHF nav radios and identified and the QDM for the approach is set up in the course window. The mode selector should be set to AUTO / APP. The annunciator will show that the FDS is looking to capture the LOC. After beam capture, in a similar manner to VOR tracking the FDS will (given enough distance) arrange the intercept to establish on the localizer with a turn demand and the annunciator panel will indicate LOC capture.

The FDS is now looking for the glideslope signal and so the annunciator GS light or MI will indicate such. As soon as the glideslope is captured the annunciator changes again and the FDS will indicate a pitch nose down demand to fly the ILS glideslope.

If the interception of the localiser has been misjudged it is possible to end up established on the localiser past the point of GS intercept i.e. above the glideslope. Modern systems may automatically adjust and capture from above by increasing the rate of descent. On older aircraft it was sometime possible to temporarily switch the FDS mode to MAN / GS. This forces the FDS into accepting a capture from above. It can also be used to establish a fixed intercept angle of the LOC beam and to force a LOC or GS capture condition if it is known that the beam- sensing circuits of the computer are inoperative.

FD Go Around (GA)

For the 737-400 series of a/c 2 criteria must be met before the FD can engage in the GA mode. The FD switches can be either on or off and:

In-flight below 2000' RA and not in the TO mode

TO/GA switch pressed

After engaging in GA, command bars appear for both pilots, TO/GA is annunciated for the FD pitch mode, the MCP IAS/MACH display blanks and the Airspeed Cursors display manoeuvring speed for the existing flap setting.

Below 400' RA, both of the FD switches must be turned from ON to OFF to exit the FD GA mode. Above 400' RA, other pitch and roll modes can be selected. If the roll mode is changed first, the FD pitch mode remains in the GA mode. If the pitch mode is changed first, the FD roll mode automatically changes to HDG SEL.

Engaging an AP following a FD GA automatically engages both the AP and FD in LVL CHG and HDG SEL for pitch and roll respectively.

For a 2 engine GA the FD command a 15 degrees nose-up pitch and roll to hold the approach ground track at the time of engagement. After reaching a programmed rate of climb, pitch commands hold the manoeuvring speed for each flap setting.

During a single engine GA the FD pitch command is initially to 13 degrees nose-up but as climb rate increases, FD pitch commands maintain a target speed. Roll commands are the same as for the 2 engine case. If engine failure occurs prior to GA engagement, then MCP selected speed becomes the target speed. If the engine failure occurs after GA engagement, then FD target speed depends on whether 10 seconds have elapsed since GA engagement:

- If prior to 10 seconds, the MCP selected approach speed becomes the target speed.
- If after 10 seconds and the airspeed at engine failure is within 5 kts of the GA engagement speed, the airspeed that existed at the GA engagement becomes the target speed.
- If after 10 seconds and the airspeed at engine failure is more than 5 kts above GA engagement speed, then the current airspeed becomes the target airspeed.

In all cases, the GA target speed is not less than V2 speed based on flap position unless in wind-shear conditions.

The FD target speed is displayed on the MCP and by the airspeed cursors. No commanded acceleration can occur until a higher speed is selected on the MCP.

FD Manoeuvre Protection

Because the modern FDC is configured for each particular aircraft type it will have the aircraft performance parameters stored in its memory. As it has inputs from the ADC and other systems it can ensure that it **never commands a manoeuvre which will over-stress the aircraft**. This is the beginning of the systems used for protection in aircraft with fly by wire controls (discussed fully in another chapter).

Flight Director Gain Scheduling

Gain scheduling is the varying of the gain of the pitch and roll demands of the FDC in relation to the task. This has many parallels with autopilot gain scheduling or gain adaption. The FD mode of operation using gain scheduling is the FDA. As the approach progresses the glideslope beam converges with the runway (which is how it works and what we want). The ILS works as a beam set at a certain angle diverging from the runway, normally about 3 degrees. ILS equipment displays that received signal as an error in degrees from the ideal.

At 6nm one degree of error equates to about 608ft of vertical distance. At ½nm that same one degree of error equates to about 54ft of vertical distance. It should be obvious that although the indications on the raw ILS glide-slope will be the same, a less forceful correction is required as the aircraft nears the ILS transmitter. **So the FD computed information must be modified as the approach progresses to reduce the commanded corrections.**

As the aircraft approaches touch-down the magnitude of the pitch changes required to follow GS reduce. Gain scheduling reduces the magnitude of the commands as the aircraft proceeds on the FDA. So initially the FDS can demand manoeuvres almost to the full authority of the system. As the threshold approaches however, the gain is reduced to perhaps a ½ or 1/3 of the original value.

The initiation of this scheduling can come in many forms depending on the age of the system: Early systems simply used time e.g. 45 seconds after GS capture the gain is reduced. The next systems used the Marker Beacons to try to actually match the scheduling required to the approach being flown. This system has fallen into disuse however because of the loss of the marker beacon systems at many airfields. Radio Altimeter. This relies on no ground signals and gives accurate scheduling in relation to actual aircraft height. This also means that the actual scheduling can be phased in gradually as opposed to the stepped method of the timing or marker systems.

Gain scheduling or adaption can be made to occur for any change in the flight regime to reduce the demands from the flight director to ensure adequate safety.

DUAL FDS

When, as on large aircraft 2 FDS are fitted (one for each pilot), each system can be used to monitor the indications of the other. This system is the FD Comparator or Monitor.

The FD Comparator monitors command bar positions. The command bars are removed when a difference is sensed between the 2 FDS of approximately 1 to 4 degrees of pitch and / or 3 to 9 degrees of roll. FD command bars reappear when the difference returns to within limits.

FD comparison is only active during certain modes of FD operation. First, both FD switches must be on and neither autopilot engaged. Second, it only operates in either the TOGA or APP mode below 800 ft RA.

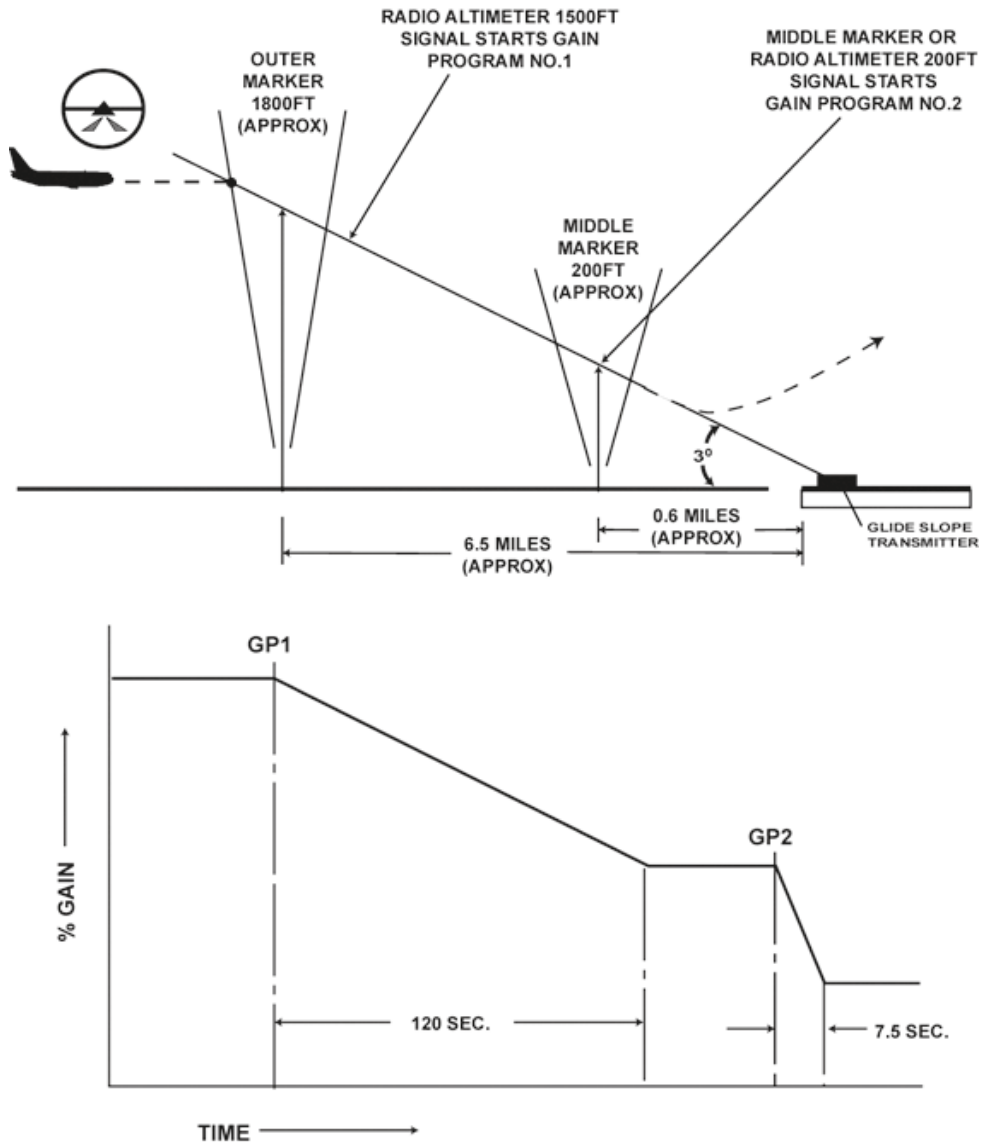

FD comparison is inhibited for several reasons. It is inhibited on the ground or when either FD is affected by electrical bus transfer. Also, it is inhibited by failure of either a FD sensor or an FD itself.

Having 2 FDS also means a certain amount of redundancy in the system. It also means that if one system should fail, as long as the associated display equipment is serviceable, both sets of display can if necessary be run from one FDC. This on electro-mechanical instruments is often simply a switch which when operated, splits the FDC output from the serviceable FDS instrument amplifier and feeds it into both sets of ADIs and HSIs. The flight instrument and FD power (and that of navigational information sources) may also be separate to aid redundancy.

EFIS equipped aircraft have a spare symbol generator also to retain extra redundancy.

CHAPTER TWENTY SEVEN

AUTOPILOT

Contents

INTRODUCTION 369

THE AUTO PILOT 369

FAIL SAFE AUTOPILOT 370

CONTROL LOOPS. 371

AIRCRAFT INNER LOOP CONTROL SYSTEM 372

TYPES OF AUTOPILOT. 374

JAR-OPS REQUIREMENTS. 375

TYPES OF ACTUATOR 375

ENGAGEMENT CRITERIA. 377

TRIM. 379

OUTER LOOP CONTROL 381

MODE ANNUNCIATOR 383

AIRCRAFT SENSOR INPUTS TO THE AUTOFLIGHT COMPUTER 384

AUTOPILOT IN OPERATION 390

OTHER AUTOPILOT FEATURES 390

AUTOPILOT LIMITATIONS AND OPERATIONAL RESTRICTIONS. 392

FLIGHT MANAGEMENT SYSTEM 393

INTRODUCTION

The main purpose of the autopilot is to relieve the pilot of the physical and mental fatigue of flying the aircraft, especially during long flights. This will result in the pilot being more alert during the critical phase of landing the aircraft safely.

Autopilot systems also enable the aircraft to fly a prescribed route accurately due to the autopilots' ability to react quicker than a human pilot to disturbances.

Many different autopilot systems exist offering many different modes of operation and facilities. Generally, however, today's modern airliner, when fitted with an auto-throttle system, will have the facility to fly the aircraft automatically for almost the entire route. In each such system, the autopilot flies the aircraft as it responds to commands from attitude sensors, navigation systems, and pitot-static systems. Power is controlled through the engine throttles moved by auto-throttle servos responding to commands from the thrust management computer.

It should be noted that, as yet, the autopilot does not carry out the take-off which has to be done by the pilot. The autopilot, though, can be engaged shortly after take-off at about 400 feet or possibly even a lower height.

THE AUTO PILOT

The basic autopilot has been in existence for about 50 years. It was introduced as an aid to the pilot flying the aircraft for 2 major reasons:

Reduction in Workload

Allowing automatic systems to fly the aircraft means that the crew not only are more rested for the more demanding phases of flight, but it also allows the pilots to concentrate on other tasks such as navigation.

The Response Time

An autopilot is much quicker than a human and as a result it can fly aircraft more accurately. A human pilot takes approximately 1/5 of a second (200 milliseconds) in detecting a change in the aircraft's attitude and then instigates a further delay while deciding which control to apply to oppose the disturbance. An autopilot will detect a disturbance and put on the required control to correct the disturbance in approximately 50 milliseconds.

FAIL SAFE AUTOPILOT

With any automatic system it is necessary to protect against malfunctions - in particular, runaways. This is achieved either by limiting the authority of the actuator or the rate at which the actuator can travel. In this way the pilot should always be able to override the effects of a malfunction and retain control of the aircraft in the event of autopilot failure. Such a system would be called a fail-safe system and the term applies to any single autopilot.

The Basic Autopilot

The basic autopilot is a very simple system. Understanding of the basic autopilot is essential for understanding and explaining what any autopilot is doing throughout the flight.

Aircraft Stabilisation

This is the key function for an autopilot (and this is all that some basic autopilots may achieve). All the modes such as VOR tracking and altitude hold etc. are "extras".

Consider an early aircraft design. All that was originally required was a system that would keep the aircraft flying in the same attitude once the pilot was happy. He could then concentrate on navigation, disengaging the autopilot as necessary to correct headings and so on. To design such a system we need to consider the sequence of events that must occur to keep the aircraft's attitude constant. Consider yourself flying a light aircraft e.g. a Warrior in slightly turbulent conditions. Now consider that the aircraft experiences a disturbance in pitch:

A human pilot controls the aircraft's stability by sensing a change in aircraft attitude, computing the necessary corrective action required and using his muscles to move the flight controls. He will then sense that corrective action has taken place and move the flight controls back to remove the correcting input.

The Autopilot is capable of producing the same actions as the pilot to maintain aircraft stability in a shorter reaction time. It must detect the disturbance and then work out appropriate corrective action. It must then apply that correction using its "muscles". Finally it must detect that the correction has taken place and re-centre the controls. This is known as inner loop control (or sometimes closed loop or auto-stabilisation). In list form it can:

- Sense changes in attitude
- Compute the amount and direction of control required.
- Provide the muscle to move the control surfaces using servo-motors.
- Detect that the control has been applied and that the aircraft has responded.
- Return control surfaces back to the neutral condition when the disturbance has been corrected.

As you will learn in the principles of flight aircraft will naturally tend to be stable in any case so you may wonder why go to the bother of installing this basic autopilot. Yes aircraft are naturally stable but you will learn that there are different type of stability and that stability can change with respect to the ambient conditions. The basic autopilot then augments and fine-tunes this stability to provide enhanced stability over a greater range of ambient conditions.

It must be emphasised that the most basic autopilot available will be of a type that will only provide auto-stabilisation.

CONTROL LOOPS

An autopilot is a control system which uses control loops. The inner loop is a classic example of a closed loop control system (hence one of its common titles). Outer loop (which will be described later) is sometimes described as an “open loop”. This is not quite correct as there is still feedback in the system. The best name for it is the outer loop because of how it acts on the inner loop to achieve its aims.

The basic elements of a closed loop control system are shown in Figure 27.1 and comprise:

- Input
- Error detector
- Output
- Control element
- Feedback

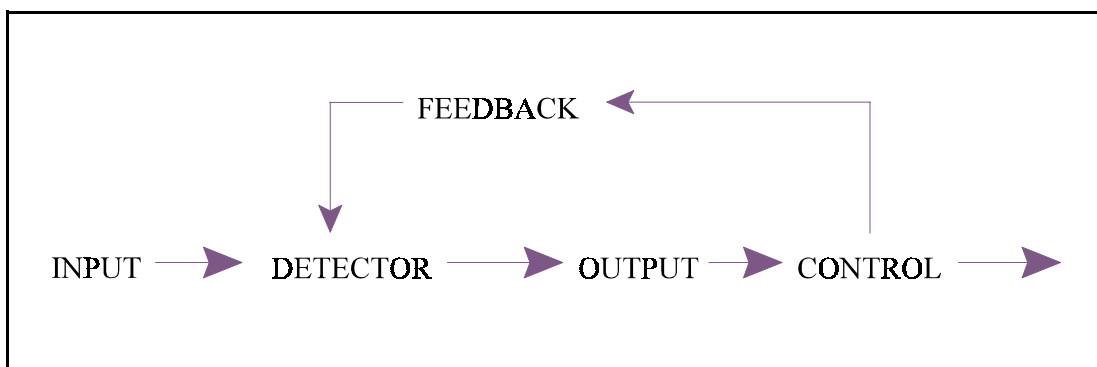

Figure 27.1 Closed Loop Control

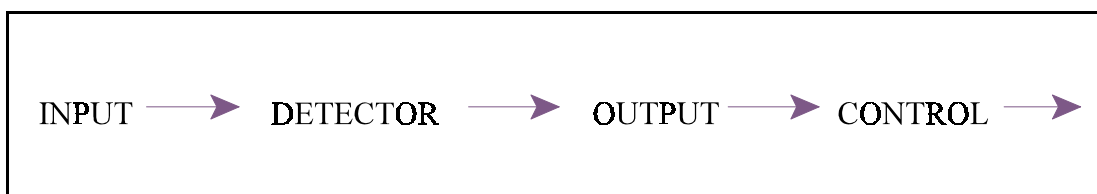

Figure 27.2 Open Loop Control

Figure 27.2 shows an open loop control system which does not have feedback. The controller may consist of a pre-determined programme or a human operator. However, if a human operator is used then the system, in effect, becomes a closed-loop system with the human closing the loop and feeding back the output signals.

The difference between open loop and closed loop systems can be illustrated by the domestic central heating system. A system with a timing controller but no thermostat would be an open loop system i.e. the pump would continue to send hot water round the house regardless of the room temperature for the duration of the period set on the timer control. On the other hand, a system with a thermostat would interrupt the circulation when the room temperature reaches the pre-selected level i.e. it has feedback control.

Feedback control systems used for positional control e.g. aircraft flying controls, are usually referred to as servo systems or servomechanisms. An essential feature of such a system is that a low power error signal is used to control the supply of power to the control elements that consist of pneumatic, hydraulic or electrical servo-motors; in other words, there is some form of power amplification in the system.

AIRCRAFT INNER LOOP CONTROL SYSTEM

The components of an inner (closed) loop control system in an aircraft shown in Figure 27.3 are:

Attitude sensor

A rate gyro senses disturbance of the aircraft in one axis only.

Transducer

Converts mechanical movement of the gyro into an electrical signal.

Signal processor

The Error detector. Compares the signals from the transducer with the input signals, determines the required corrective action (the error) and transmits a signal to the servo-motor. Receives and compares position and rate of movement feedback signals from the servo-motor.

Servo-motor

Converts processed signal into movement of the aircraft flight controls proportional to rate and direction of signal. Uses hydraulic, electric or pneumatic power.

Aerodynamic Feedback

The attitude reached by the aircraft is sensed by the rate gyro which gives a measure of the output.

A disturbance to the selected flight path produces an error signal; the autopilot operates to move the aircraft back towards its stabilised condition. This causes the error signal from the transducer to be progressively reduced and therefore removes the control surface deflection after the disturbance has been corrected.

Inner Loop systems

Inner loop systems are those that provide the auto-stability only. It is the Innermost control Loop.

Outer Loop systems

Outer loop systems are those extra facilities offered e.g. Altitude Hold, Heading Hold, LNAV, VNAV. They are still essentially loops (so there is still some confusion occasionally) but they act from an external position on the inner loop and "fool" the inner loop into manoeuvring the aircraft into achieving its aim.

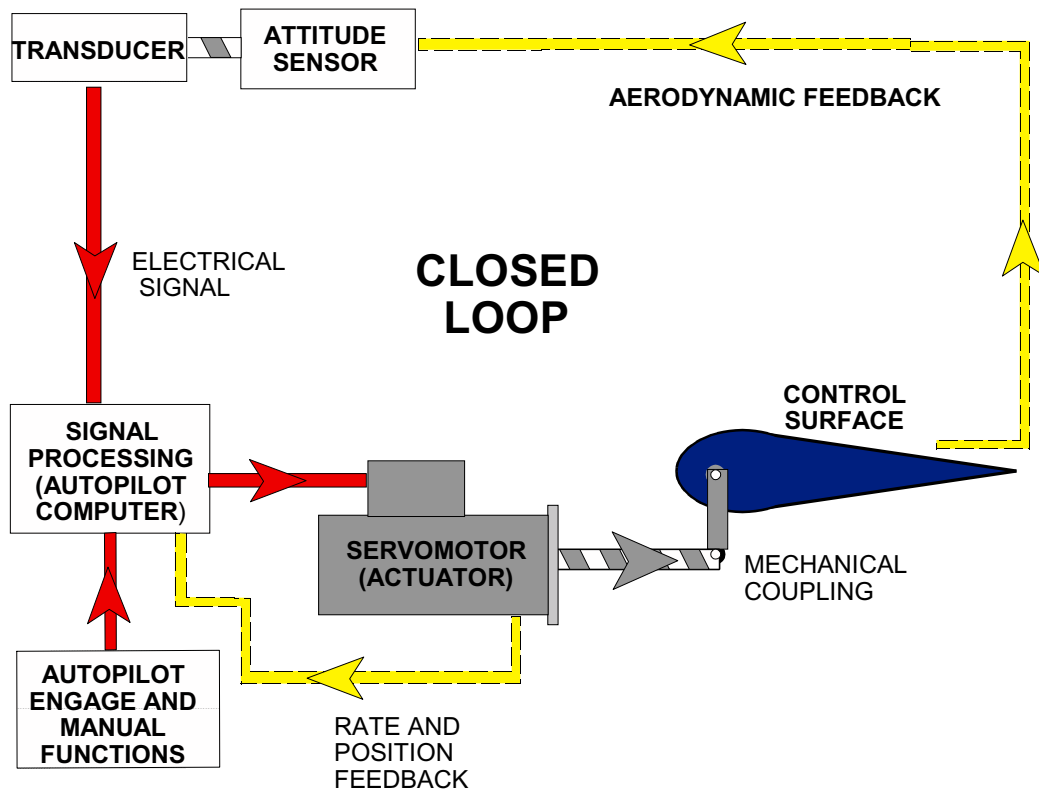

Figure 27.3 Closed Loop of Inner Loop.

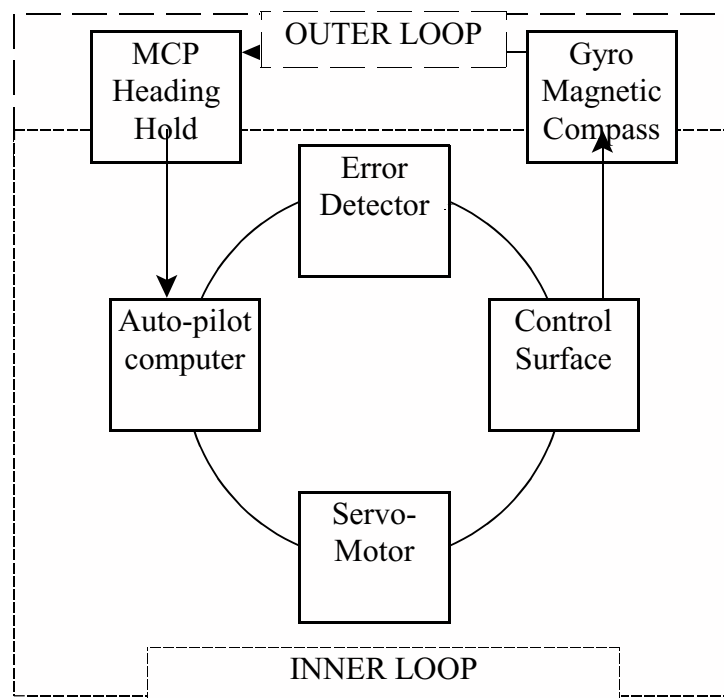

Figure 27.4 Diagram showing the relationship of an outer loop function to the inner loop.

TYPES OF AUTOPILOT

An aircraft can be subjected to disturbances about its three control axes i.e. longitudinal (roll), lateral (pitch) and vertical or normal (yaw). Stabilisation must therefore be controlled about the same three axes. Autopilot systems are broken down into three basic control channels:

- Roll to control the Ailerons
- Pitch to control the Elevators
- Yaw to control the Rudder

It is therefore possible to get an autopilot that is classed as single axis, twin axis or triple axis. There will be a separate inner loop for each axis of autopilot control. If an aircraft has more than one autopilot there will be one inner loop for each axis of control for each autopilot.

A Single Axis System.

A single axis attitude control system would normally be limited to the roll axis only, i.e. a single autopilot channel controlling the ailerons. At its most basic, the single axis system will only give lateral stability or level the wings. The roll axis is known as the primary axis. This system is sometimes simply called a Wing Leveller.

A Two Axis System.

A two axis control system would control the aircraft attitude about the roll and pitch axes. The pitch axis is known as the secondary axis. There are two autopilot channels which control the ailerons and the elevators. Systems can vary in complexity from the fairly simple set-ups which can be found in smaller aircraft, having only a few basic modes of operation, up to the most intricate integrated systems with full flight profile modes of operation, including auto-land modes. Two axis systems may have an aileron/elevator cross-feed to keep the nose up in a turn.

A Three Axis System.

A three axis system would give attitude control about all three axes, namely roll, pitch and yaw. The yaw axis is the third or tertiary axis. The roll and pitch channels are used as the primary control channels. It is these two channels to which outer loop signals (discussed later) are fed to control the various modes. The rudder channel is basically a stability channel. It is common to have interaction between the roll channel and rudder channel to assist in co-ordinated turns and to give faster stability response. On aircraft that require it, a yaw damper will be fitted as a standby rudder channel but would operate independently of the autopilot.

JAR-OPS REQUIREMENTS

Single pilot operation under IFR

An operator shall not conduct single pilot IFR operations unless the aeroplane is equipped with an autopilot with at least ALTITUDE HOLD and HEADING MODE. This means that the aircraft must have at least a two-axis autopilot.

Installation of automatic pilot system

Each automatic pilot system must be approved and must be designed so that the autopilot can be quickly and positively disengaged to prevent it from interfering with the control of the aeroplane.

Unless there is automatic synchronising, each system must have a means to readily indicate to the pilot the alignment of the actuating device in relation to the control system it operates.

Each manually operated control for the system must be readily accessible to the pilots.

Quick release (emergency) controls must be on both control wheels, on the side of each wheel opposite the throttles.

Attitude controls must operate in the plane and sense of motion specified for cockpit controls. The direction of motion must be plainly indicated on, or adjacent to, each control.

The system must be designed and adjusted so that it cannot produce hazardous loads on the aeroplane, or create hazardous deviations in the flight path, either during normal operation or in the event of a malfunction.

If the autopilot integrates signals from auxiliary controls or furnishes signals for operation of other equipment, there must be positive interlocks and sequencing of engagement to prevent improper operation. Protection against adverse interaction of integrated components, is also required.

Means must be provided to indicate to the pilots the current mode of operation and any modes armed by the pilot.

TYPES OF ACTUATOR

Actuators produce the physical movement of the control surfaces and can be of different types depending on their principle of operation which can be:

- **Electro-mechanical**
- **Electro-hydraulic**
- **Pneumatic**

There are two types of configuration in which actuators are connected to the flying controls:

Parallel

The actuator produces the movement of the control surface as well as providing feedback to the control stick i.e. the stick will move when the autopilot is controlling the control surfaces.

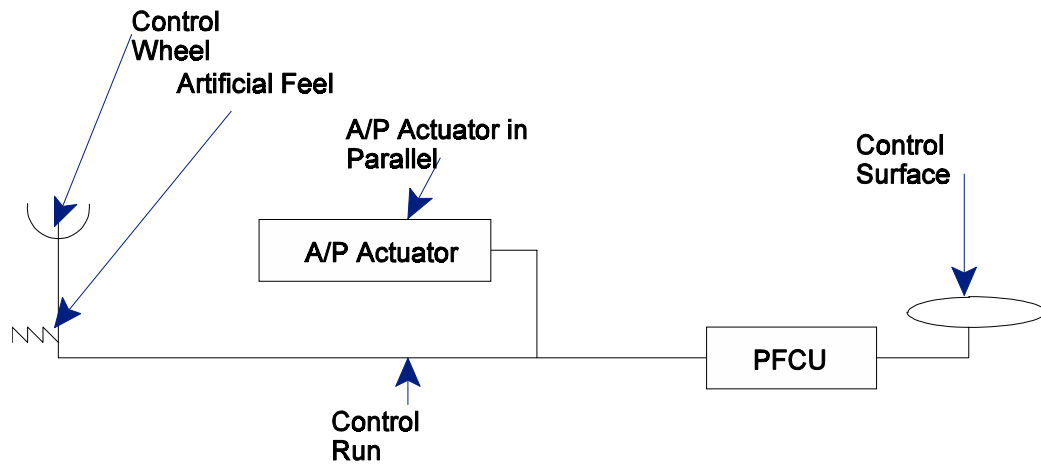

Figure 27.5 A/P Actuator in Parallel

Series

The actuator produces movement of the control surface but not the control stick.

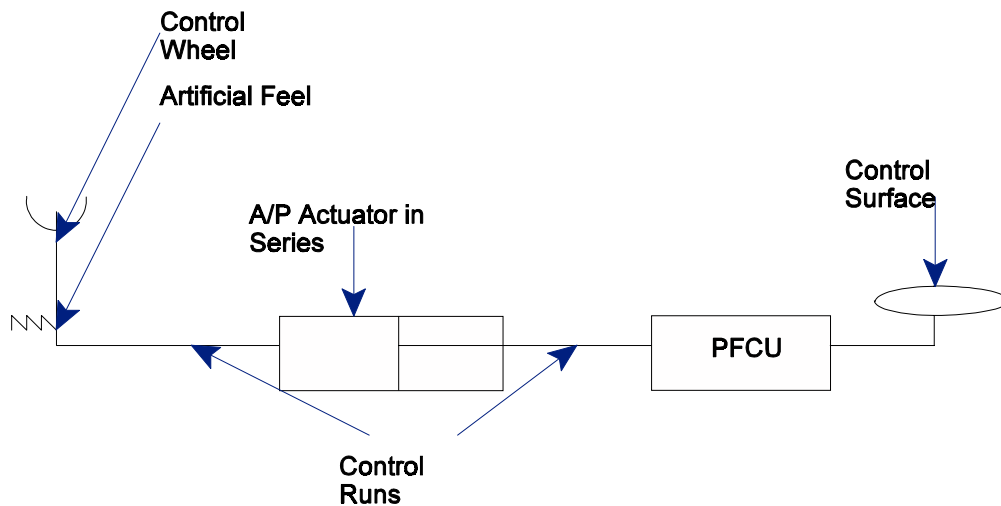

Figure 27.6 A/P Actuator in Series

It is also possible to have a combined series/parallel configuration.

Torque Limiter

In flight, particularly where high rates of control are to be produced, the movement of the flight control surfaces can result in loads which may impose excessive stresses on the aircraft structure. It is necessary therefore, under automatically-controlled flight conditions, to safeguard against such stresses, and furthermore to safeguard against a servo-motor 'runaway' condition which would cause control surfaces to be displaced to their maximum hard-over positions.

Such safeguards are implemented by limiting the torque applied to the servo-motors, and also by allowing them either to slip, or to be completely disengaged, in the event that present torque limits are exceeded. The methods adopted usually depend on either mechanical, electrical or electromechanical principles.

ENGAGEMENT CRITERIA

Autopilot Interlocks

Before coupling an autopilot with the aircraft's control system the integrity of the Autopilot Inner Loop must be established to ensure that it may safely take control of the aircraft. To monitor the performance of the inner loop components a system of interlocks is provided which close to allow autopilot engagement and hold it engaged if the correct valid signals have been received. The function of the interlocks can be represented by a number of relays in series (see Figure 27.7), although in modern aircraft the actual switching is more likely to be accomplished by solid state logic switching. Failure of a circuit monitored by a relay will cause the autopilot to disengage accompanied by the associated aural and visual warning indications. Operation of the disengage switch will have the same effect.

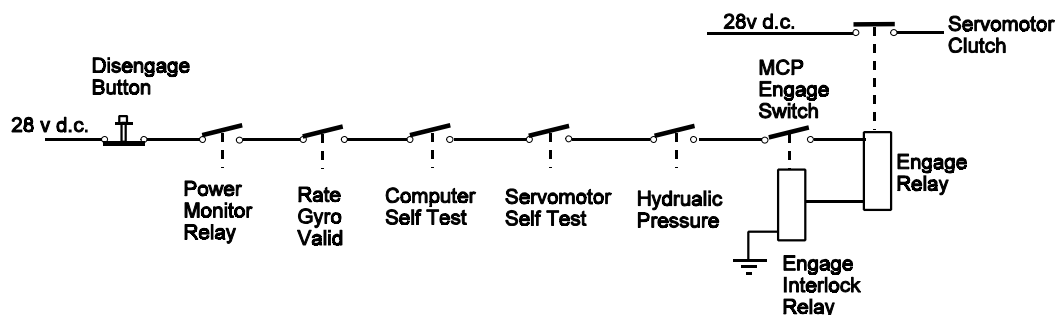

Figure 27.7 Autopilot Interlocks

Conditions of Engagement

Before the autopilot can be engaged certain conditions must be met. These conditions vary with aircraft type. For the 737-400 these conditions are as follows.

Each autopilot can be engaged by pressing a separate CMD or CWS engage switch. A/P engagement in CMD or CWS is inhibited unless both of the following pilot-controlled conditions are met:

No force is being applied to the control wheel.

The Stabiliser Trim Autopilot Cut-out Switch is at NORMAL.

Once the above conditions are satisfied and no failures exist, either A/P can be engaged in CMD or CWS by pressing the respective engage switch. Control pressure applied after an A/P is engaged in CMD, overrides the A/P into CWS pitch and/or roll. The light remains illuminated in the CMD engage switch.

The A/P automatically disengages when any of the following occur:

- Pressing either A/P disengage switch.
- Pressing either TOGA switch with a single A/P engaged in CWS or CMD below 2000ft RA.
- Pressing either TOGA switch after touchdown with both A/Ps engaged in CMD.
- Pressing a lighted A/P engage switch.
- Pushing the A/P disengage bar down.
- Activating either pilot's control wheel trim switch.
- Moving the Stabiliser Trim Autopilot Cut-out Switch to CUT-OUT.
- Loss of respective hydraulic system pressure.
- Repositioning the EFI transfer switch.
- Either left or right IRS system failure or FAULT light illuminated.
- Loss of electrical power or a sensor input which prevents proper operation of the engaged A/P and mode.

Only one A/P can be engaged at a given time unless the approach (APP) mode is engaged. Pressing an engage switch for the second A/P, while not in the APP mode, engages the second autopilot as selected and disengages the first A/P. The second A/P then operates in CWS or CMD without interrupting CWS or command operation.

If an A/P is engaged with the CMD engage switch during FD only operation while pitch or roll commands are more than ½ scale from centred, the A/P automatically engages in CWS for pitch and/or roll and the FD command bars retract.

Automatic Synchronisation

In addition to the pre-engage requirements that the autopilot circuits are electrically complete, it must also be ensured that on engagement the 'take-over' is affected smoothly and without 'snatching' of the aircraft's control system. In other words the aircraft must be trimmed for the desired flight attitude before engagement and the automatic control system must be synchronised to maintain that attitude on engagement.

In the majority of autopilot systems synchronisation is effected by specifically designed synchronising circuits which automatically sense any existing 'standing signals' in the pitch and roll channels and automatically reduce or 'wash out' these signals to zero. This stops the servo-actuator in a position which is synchronised with the datum attitude detected by the sensing element, such position being indicated by the return of the trim indicator pointer to its central position.

TRIM

Manual Systems

The purpose of the trim system is to relieve the pilot of forces on the aircraft controls while maintaining aircraft attitude. In manual control, trim on light aircraft is provided in all three axes through mechanical linkages to trim tabs on the control surfaces. On larger aircraft this is usually achieved by electrical actuators that bias the Powered Flying Control Unit (PFCU), particularly for pitch trim. Trim steering signals would be provided to the trim tab actuators for elevator, aileron and rudder as well as to the horizontal stabiliser.

Manual operation of the pitch trim will, in most systems, automatically disconnect the autopilot as it cannot co-ordinate manual trim movement with movement of the C of G or aerodynamic movements.

Automatic Trim (Auto-trim)

As the aircraft uses fuel the C of G position will move. If we are flying the aircraft manually we would trim these forces out manually to eliminate stick forces. Currently as our basic autopilot stands if it is flying the aircraft and the C of G changes it will simply hold the stick forces using the brute strength of its servo-motor outputs. This will not pose much of a problem unless the forces overwhelm the servo-motor or until such time as we wish to disconnect the autopilot. Not only does this mean that the aircraft is producing more drag than necessary but if there is a standing load on the controls when we disconnect the autopilot we will not know of its existence or which way the aircraft will pitch. The aircraft will “snatch” or lurch in response to the out of trim condition. This is not a very satisfactory situation so a system of Automatic Pitch Trim was included in most autopilot systems.

When the autopilot is engaged automatic trim is available only in pitch. This is called Automatic Pitch Trim or simply Auto-trim. Auto-trim is active only when the autopilot is engaged (excluding the Airbus series of Fly by Wire aircraft which are a special case). It is typically achieved by a separate trim servo actuator operating either the normal trim tab or, more commonly on modern jet transports, the variable incidence horizontal stabiliser. The latter permits the elevator to always be in neutral position with respect to the horizontal stabiliser, therefore allowing the autopilot full elevator control authority both sides of the trimmed position. Another important consideration is that in the event of autopilot disconnect the aircraft will be in a trimmed condition and thus will not suddenly pitch up or down.

The out of trim condition is sensed most commonly by using one of two methods:

- A standing load being sensed on an electrical actuator. Due to the out of trim situation the autopilot is having to hold a force against the out of trim condition in exactly the same way as a pilot would have to. The magnitude of the load on the actuator is going to be directly proportional to the force being held, and of course the direction is known from which way the actuator is having to apply that load. That information can be used to move the normal trimming system of the elevators to reduce the standing load to zero. The aircraft is now in trim.
- The actual position of the actuator. If there is an out of trim force to be coped with the actuator will be positioned to input the required control displacement to hold that force. The displacement of the actuator will again give the direction and magnitude of the force. Large modern aircraft tend to use Trim Tails or all moving tail-planes. Both of these systems due to the way they trim reset the control inputs to give full elevator movement up and down from the trimmed position. So now, as the Auto-trim moves the normal elevator trim, the displacement of the normal control input is reset, removing the actuator displacement.

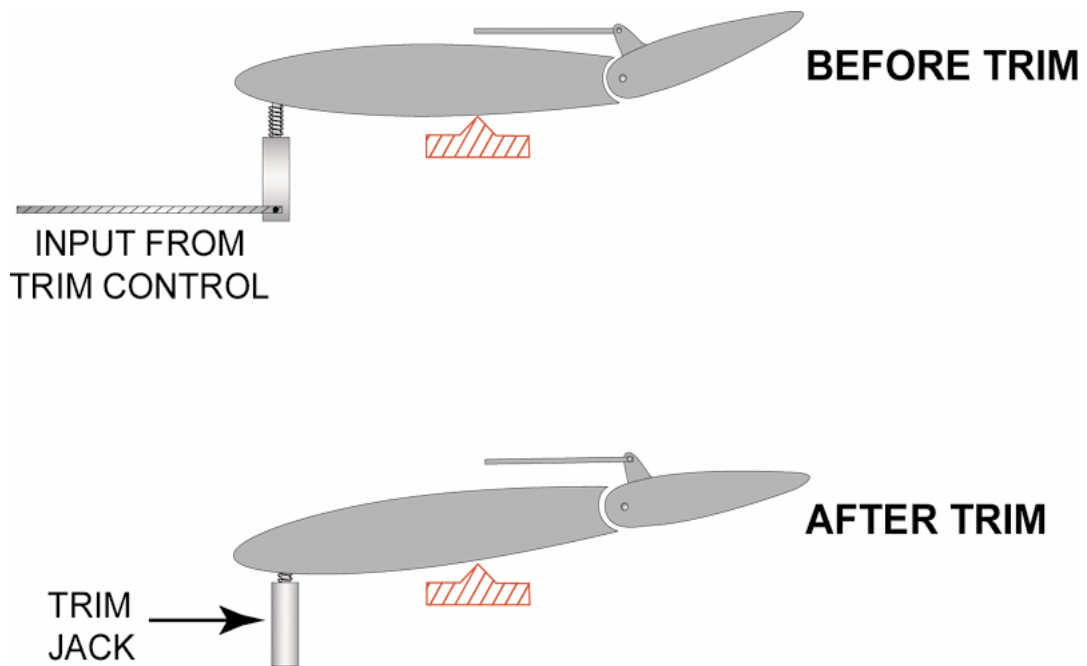

Figure 27.8 Trimming by variable incidence tailplane

The output is applied to the trim tab actuator or the horizontal stabiliser.

In the event of a failure of the trim system the pilots would be alerted by warning lights and/or suitable indications on the electronic display unit. At the same time the autopilot would disengage, giving both visual and aural alerts. The latter can also sound when there is an excessive trim input as, for example, in an actuator runaway situation. If the auto trim system is not available, then the autopilot may become inoperative (will become inoperative for the B737-400). If another autopilot is available it would be common practice to use the fully operative system.

If there is only one autopilot or the aircraft is not fitted with auto-trim, the aircraft must be correctly in trim before the engagement of the autopilot to minimise the control loading expected on disengagement. The standard operating procedure for the aircraft will stipulate a time period after which the autopilot must be disengaged, the aircraft re-trimmed and then the autopilot re-engaged. This will minimise the control snatch on autopilot disengagement.

The pilots may have some indication of the trim controls but in the case of auto-trim there is always a stabiliser trim indicator and a auto-trim failure warning so that the system can be monitored during autopilot operation. The autopilot may not engage if there is too great a standing load i.e out of trim condition already present.

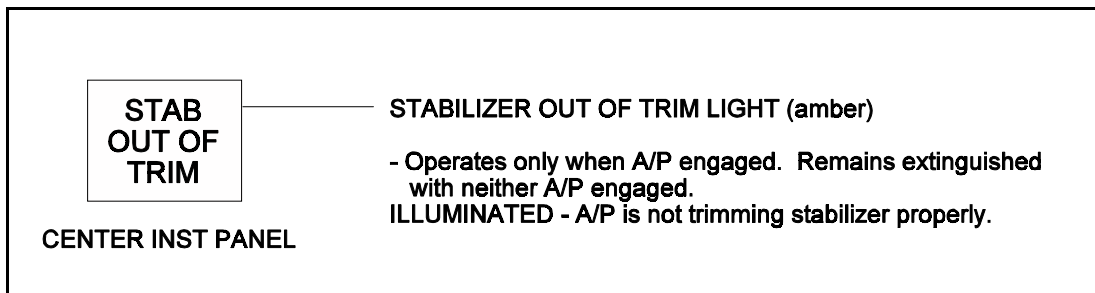

Figure 27.9 Auto-Trim Failure Light

Independent Systems

Mach trim (if required) will operate independently of the autopilot. A Mach Trim system is provided in aeroplanes that fly at high subsonic speeds and are susceptible to Mach tuck. At these speeds as the aeroplane approaches its critical Mach No. the centre of pressure moves aft resulting in a nose down attitude known as Mach tuck. This condition is automatically trimmed out by a mach trim system. The mach trim system will be armed at all stages of flight but will only activate at high subsonic speeds.

Yaw dampers will be covered in detail in another chapter. They are however another example of an inner loop system.

OUTER LOOP CONTROL (ALSO KNOWN AS FLIGHT PATH MODES)

In addition to performing the primary function of stabilisation, an Automatic Flight Control System (AFCS) can also be developed to control the path of the aircraft horizontally or vertically to predetermined conditions. For example to hold a selected airspeed, altitude, magnetic heading or intercept and track radio beams from ground-based aids, etc. The number of inputs available serve as an indication of the progressive development of automatic flight from the basic single-axis wing-levelling type of autopilot, to the highly sophisticated flight guidance systems now used in many present-day transport aircraft.

The outer loop inputs are applied to the inner loop in such a way as to fool the auto-stability control into believing that the aircraft is being disturbed. The inner-loop systems reaction to the input is calculated to produce the result required, such as altitude holding or turning to follow a heading.

Such data inputs constitute **Outer Loop Control** and can be referred to as **Command Modes** or **Flight Path (Referenced) Modes**. Outer Loop command modes are coupled to the relevant autopilot channel by selection on the Mode Control Panel (MCP) which is located on the glare-shield and provides the pilot's interface with the auto-flight system. A typical example of modern twin jet MCP is shown in Figure 27.12. It allows the pilot to engage an autopilot and select any of the pitch and roll outer loop inputs. Incorporated in the selector switches are lights to indicate which autopilot or command modes are engaged.

Only one command mode may be engaged in a single channel at any one time (i.e. one in Roll and one in Pitch). So it is impossible for the autopilot to maintain a speed for example by pitching the aircraft and at the same time hold a height by pitching the aircraft. Do not confuse this with those auto flight control systems that include auto throttle / thrust.

The provision of raw data inputs relevant to a particular flight path is referred to as 'coupling' or as a 'mode of operation'. Other terms commonly used in connection with operating modes are 'hold', 'lock', and 'capture'. For example, an aircraft flying automatically at a selected altitude is said to be in the 'altitude hold' or 'height lock' mode. The term 'capture' relates principally to modes associated with the selection and interception of beams from ground-based radio navigation aids; for example, 'glide slope capture'.

In some cases, mode switching is automatic, thus, to switch from intercepting a beam or a heading, to tracking the beam on reaching it, a **Beam Sensor** is installed. This device senses beam deviation and switches modes automatically when the aircraft flies into the beam. Glide slope capture can also take place automatically, in this case the pitch control channel is switched from 'altitude hold' mode to glide slope track when the aircraft flies into the glide slope beam.

The raw data is supplied from aircraft sensors (attitude, air data, heading, radio etc.) to the relevant auto-flight computer which compares the data with the selected values on the MCP and computes control inputs to achieve those selected values.

In a modern transport aircraft which is using a flight guidance system with an automatic landing capability, the outer loop inputs could comprise some or all of the modes listed in the following table.

Roll Channel

- Heading hold
- Heading select
- VOR intercept and track
- LOC intercept and track
- Inertial Nav or L.NAV

Pitch Channel

- Altitude hold
- Speed hold
- Mach hold
- Vertical Speed
- V.NAV

Auto-land

Roll Channel	Pitch Channel	Yaw Channel
Localiser	Glideslope	Runway align
Roll-out	Flare	Roll-out

MODE ANNUNCIATOR

The Mode Annunciator will indicate the current auto-flight system status and can be a separate indicator or an integrated part of the EFIS primary flight display (Figure 27.10). The electronic display indicates armed and engaged modes of the auto-flight system in different colours. It can also indicate autopilot, autothrottle, auto-land and flight director status.

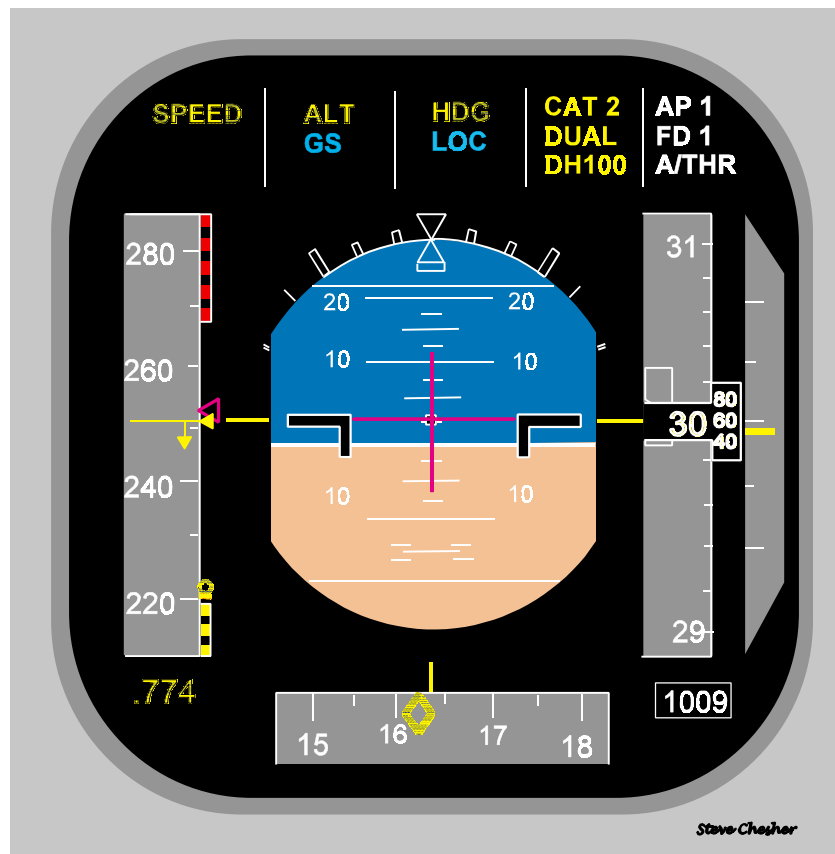

Figure 27.10 Primary Flight Display.

There will also be illuminated switches or simply warning lights that will indicate whether an autopilot is engaged, warning of disengagement, warning of auto-throttle disengagement, failure to achieve target speed and of auto-trim failure.

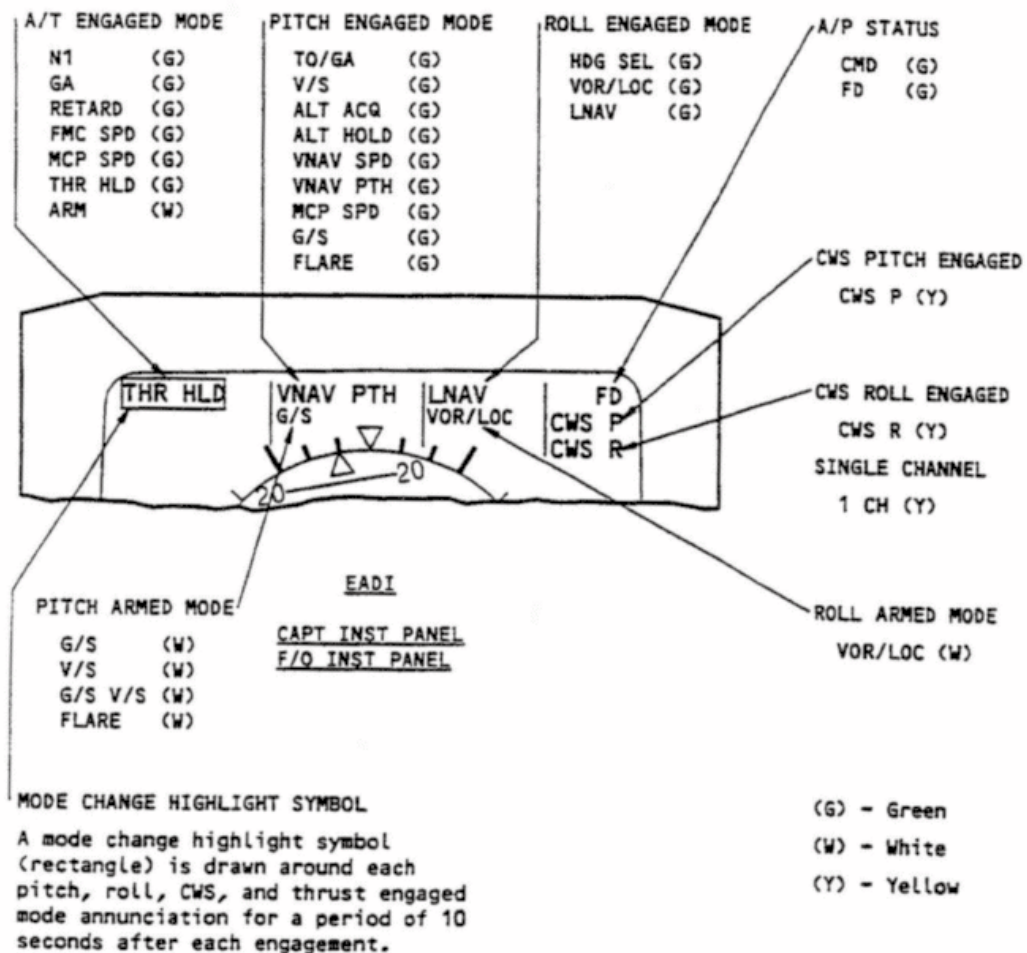

Figure 27.11 Boeing 737-400 Flight Mode Annunciations.

AIRCRAFT SENSOR INPUTS TO THE AUTOFLIGHT COMPUTER

Manometric (Or Air) Data.

Raw data inputs which come under this heading are those associated with altitude, airspeed/mach No, vertical speed. Each of these provides current aircraft status for outer loop control in the pitch channel of the autopilot.

Sensing may be carried out either by independent sensor units, or by a Central Air Data Computer (CADC). The sensors operate on the same fundamental principles as the basic pitot-static instruments, the measuring elements being coupled to appropriate types of electrical transducers instead of instruments.

Attitude Reference

Attitude reference data (roll, pitch, yaw) is fed into the auto-flight computer from the primary attitude sensors which could be a Vertical Gyro and Directional Gyro combination, an Inertial Navigation System or an Inertial Reference System depending on the age of the aircraft. These sensors may also transmit data to slave the ADI and HSI.

Magnetic Heading Reference

A Magnetic Heading Reference System (MHRS or Gyro Magnetic Compass) combines inertial heading with magnetic compass heading providing magnetic heading signals to the HSI and reference data to the auto-flight computer.

Radio Navigation

To allow the auto-flight system to be able to capture and track a radio beam data signals are transmitted to the relevant auto-flight computer from the VOR and ILS receivers.

Computer Generated Data

Modern aircraft can follow a computer generated flight profile in both roll (lateral) and pitch (vertical) from a Flight Management System (FMS). Steering signals from the Flight Management Computer (FMC) are connected to the auto-flight computer to control the attitude of the aircraft.

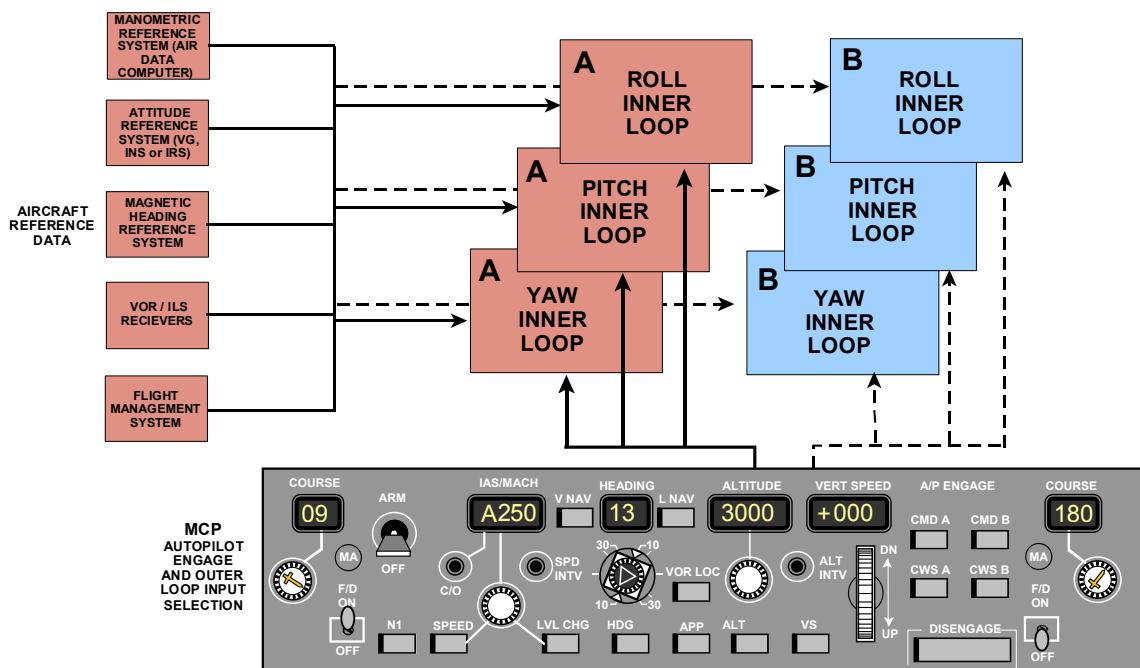

Figure 27.12 Inputs to the MCP.

An example of an AFDS (737-400)

For these notes the Boeing 737-400 is used as an example. It is also officially the AFDS that the JAR objectives and exams are currently based around. Therefore a description of the AFDS as fitted to this aircraft is given.

General

The Automatic Flight System (AFS) for the 737-400 consists of the Autopilot Flight Director System (AFDS) and the Auto-Throttle (A/T). The Flight Management Computer (FMC) provides N1 limits and target N1 for the A/T and command airspeeds for the A/T and AFDS.

The AFDS and A/T are operated from the AFDS Mode Control Panel (MCP) and the FMC from the Control Display Unit (CDU).

The AFDS MCP provides co-ordinated control of the autopilot (A/P), Flight Director (FD), A/T and altitude alert functions.

AFS mode status is displayed on the Flight Mode Annunciators (FMA) on each pilot's ADI.

Normally, the AFDS and A/T are used to maintain and or thrust settings calculated by the FMC.

Autopilot Flight Director System (AFDS)

The AFDS is a dual system consisting of 2 individual Flight Control Computers (FCCs) and a single MCP.

The 2 FCCs are identified as A and B. For A/P operation, they send control commands to their respective pitch and roll hydraulic servos, which operate the flight controls through 2 separate hydraulic systems.

For FD operation, each FCC positions the FD command bars on the respective ADI.

MCP Mode Selector Switches

The Mode selector switches are pressed to select desired command modes for the AFDS and A/T. The switch illuminates to indicate mode selection and that the mode can be deselected by pressing the switch again. While a mode is active, de-selection can be automatically inhibited and this is indicated by the switch light being extinguished.

When engagement of a mode would conflict with current AFS operation, pressing the mode selector switch has no effect. All AFDS modes can be disengaged by selecting another command mode or by disengaging the A/P and turning the FDs off.

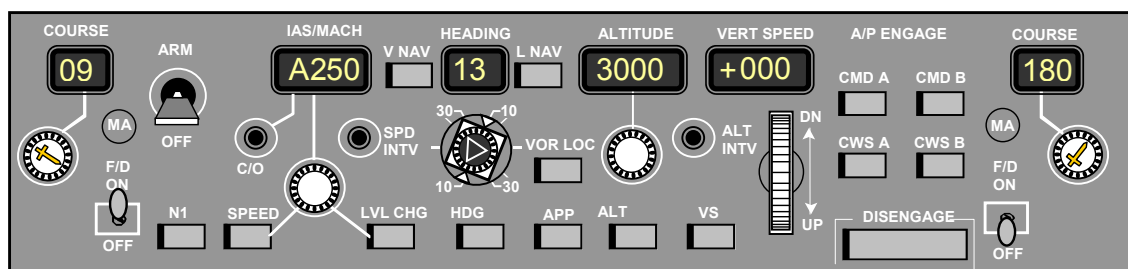

Figure 27.13 Mode Control Panel.

MCP Parameter Selection

The following information is in addition to that contained in the controls and indicators section of this chapter.

Parameter selections common to both FCCs for speed, heading, altitude and vertical speed are made from the MCP.

Two course selectors and course displays are located on the MCP. The Captain's course selector provides selected course information to the A FCC, the No. 1 VHF Nav receiver and to the Captain's HSI course pointer and course deviation bar. The First Officer's course selector provides selected course information to the B FCC, the No. 2 VHF Nav receiver and to the First Officer's HSI course pointer and deviation bar.

Examples of Outer Loop Inputs in ROLL

Heading Select and Hold

The Heading Select mode sends roll commands to turn and maintain the heading shown in the MCP Heading Display. After mode engagement, roll commands are given to turn in the same direction as the rotation of the heading selector only. The bank angle limit is established by the Bank Angle Limit Selector on the MCP.

Pressing the Heading Select Switch on the MCP engages the heading select mode. HDG SEL is annunciated for the AFDS.

The HDG SEL mode automatically disengages upon capture of the selected radio course in the VOR LOC and APP modes.

VOR Localiser tracking (VOR LOC) mode

The VOR mode gives roll commands to capture and track the selected VOR course. The LOC mode gives roll commands to capture and track the selected localiser along the inbound front course bearing. Back-course tracking is not available.

Pressing the VOR LOC switch selects the VOR mode if a VOR frequency is tuned, or selects a LOC mode if a localiser frequency is tuned. The VOR LOC switch illuminates and VOR LOC armed is annunciated.

The selected course can be intercepted while engaged in L NAV, HDG SEL or CWS ROLL, with an autopilot engaged in CMD. The capture point is variable and depends on intercept angle and closure rate. Localiser capture occurs not later than ½ dot deviation. When within the course capture area, the VOR LOC annunciation changes from armed to captured and roll commands track the VOR or localiser course.

When a localiser frequency is selected the navigation radios automatically switch from the antenna in the tail to the antenna in the nose when VOR/LOC is annunciated (armed or engaged). If antenna switching does not occur, the localiser and approach modes are inhibited.

Tracking Through VOR “Cone of Confusion”

The ‘cone of confusion’ is an area overhead a VOR navigation beacon where the signals are unusable. Thus an aircraft transiting the VOR will receive no usable signals for a period depending upon its ground-speed and altitude.

As the aircraft approaches the VOR the radials are converging and the course deviation indicator becomes more sensitive. At some point, before it enters the cone of confusion the information from the selected inbound radial becomes unusable due to the convergence. At this point the VOR signals are ‘cut off’ by the ‘over station sensing’ circuits i.e. the roll channel automatically de-couples from the radio beam and controls the aircraft through the cone of confusion on the drift-corrected heading existing when the radio signals are de-coupled. In other words the autopilot goes into Heading Hold for a set period after which it reverts to the VOR Mode. Note that the autopilot does not go into Heading Mode.

Inertial Navigation System (INS)/Inertial Referencing System (IRS)

Older aircraft without a Flight Management System may be able to couple the Inertial Navigation/Reference System to the autopilot to allow the aircraft to be steered sequentially through a series of way points that have been loaded into the INS/IRS before flight.

Lateral Navigation (L NAV)

In the L NAV mode, the FMC controls AFDS roll to intercept and track the active FMC route. The desired route is activated and modified through the FMC CDUs. In addition to en-route guidance, the active routes can include terminal procedures such as SIDs, STARs and instrument approaches.

Engagement criteria must be met to use L NAV. There must be an active route in the FMC, capture criteria must be satisfied, and the L NAV switch must be pressed.

L NAV capture criteria is divided into 2 categories. First, any aeroplane satisfies capture criteria when within 3nm of the active route segment. Second, outside of 3nm, the aeroplane must be on an intercept course of 90 degrees or less and intercept the active route segment before the active way-point.

L NAV will automatically disconnect for several reasons. It will disconnect upon reaching the end of the active route or upon entering a route discontinuity. Additionally, it will disconnect upon either intercepting or missing the intercept of an approach path inbound track. Finally, either loss of capture criteria or selecting HDG SEL will disconnect L NAV.

Examples of Outer Loop Inputs in PITCH

Altitude Hold (ALT HLD)

The altitude hold mode gives pitch commands to hold the MCP selected altitude or the uncorrected barometric altitude at which the ALT HOLD switch was pressed. ALT HOLD engages in either of 2 conditions

ALT HOLD at the MCP selected altitude. This is indicated by the annunciation of ALT HOLD and the ALT HOLD switch light extinguished.

ALT HOLD not at the MCP selected altitude. This is indicated by the annunciation of ALT HOLD and the ALT HOLD switch light illuminated.

ALT HOLD not at the MCP selected altitude occurs with either of the following:

- Pushing the ALT HOLD switch while not at the MCP selected altitude.
- Selecting a new MCP altitude while in ALT HOLD at the currently selected altitude.

ALT HOLD is inhibited after glideslope capture. When in ALT HOLD at the selected altitude, LVL CHG, V/S and V NAV climb and descend functions are inhibited until a new altitude is selected.

The altitude selected on the MCP is referenced to the Captain's barometric altimeter setting for the "A" autopilot and FDS, and to the First Officer's barometric setting for the "B" autopilot and FDS. After ALT HOLD engages, changes in the altimeter barometric settings do not change the selected altitude reference.

Altitude Acquire (ALT ACQ)

The altitude acquire mode is the transition manoeuvre entered automatically from a V/S, LVL CHG, or V NAV climb or descent to a MPC selected altitude. The altitude acquire mode is also armed while climbing or descending in CWS with an autopilot engaged.

Altitude acquire engagement is annunciated ALT ACQ in pitch when levelling off in either V/S or LVL CHG. However, V NAV remains annunciated throughout the altitude acquire mode when levelling in V NAV.

ALT ACQ engagement is inhibited when the ALT HOLD switch is pressed or while the glideslope is captured.

IAS/MACH Hold. (SPD)

This will hold a selected IAS or MACH No. by comparing selected value with actual value from the ADC and pitching the aircraft up or down to decrease or increase speed.

Vertical Speed (V/S).

The V/S mode gives pitch commands to hold the selected vertical speed and engages the auto-throttle in the SPEED mode to hold the selected airspeed. The V/S mode has both an armed and engaged state.

Pressing the V/S switch engages the V/S mode unless the ALT HOLD is engaged or after glideslope capture.

V/S engaged is annunciated, the Vertical Speed Display changes from blank to present vertical speed and desired vertical speeds can be selected with the vertical speed thumb-wheel.

The V/S mode becomes armed if, while in the ALT HOLD at the selected altitude, a new MCP altitude is selected which is more than 100 ft different than the previously selected altitude. V/S armed is annunciated and the V/S mode can be engaged by moving the vertical speed thumb-wheel.

The V/S mode automatically engages when the altitude acquire mode is engaged and a new altitude is selected which is more than 100 ft different than the previously selected altitude. The V/S mode annunciates engaged and existing vertical speed appears in the vertical speed display. The commanded V/S can be changed with the vertical speed thumb-wheel. Vertical speeds can be selected which command flight toward or away from the selected altitude.

Level Change Mode (LVL CHG)

The LVL CHG mode co-ordinates pitch and thrust commands to make automatic climbs and descents to pre-selected altitude at selected airspeeds. A LVL CHG climb or descent is initiated by selecting a new altitude and engaging the LVL CHG mode.

During a LVL CHG climb, the annunciations are MCP SPD for pitch and N1 for the auto-throttle (A/T). During a LVL CHG descent, the annunciations are MCP SPD for pitch and RETARD for the A/T while reducing the thrust toward idle. When at idle thrust, ARM is annunciated for the A/T.

If a speed mode was active prior to engaging LVL CHG, the previous speed is retained as the target speed for the LVL CHG mode. If the LVL CHG mode is engaged with no active speed mode, the IAS/Mach display and airspeed cursors synchronise to existing speed and present speed becomes the LVL CHG target speed. After LVL CHG mode engagement, the target speed can be changed with the MCP speed selector.

Vertical Navigation Mode (V NAV)

With the V NAV mode engaged, the FMC commands AFDS pitch and A/T modes to fly the vertical profile selected on the FMC CDUs. The profile includes pre-selected climbs, cruise altitudes, speeds, descents, and can also include altitude constraints at specified way-points. The profile may end with an ILS approach to the destination airfield.

Pressing the V NAV switch selects the V NAV mode provided FMC performance initialisation is complete. The mode selector switch illuminates, the MCP IAS/Mach display becomes blank and the airspeed cursors are positioned at the FMC commanded airspeed. The FMA displays are V NAV SPD or V NAV PTH for the AFDS pitch mode and FMC SPD, N1, RETARD or ARM for the A/T mode.

V NAV climbs and descents are constrained by the selected MCP altitude. V NAV commanded speeds can be changed with the FMC CDUs.

During VNAV path cruise flight, selecting a lower MCP altitude, arms the FMC to automatically begin the descent upon arrival at the FMC calculated top of descent point.

During a V NAV path descent, V NAV remains engaged until:

Glideslope capture, or
Another pitch mode is selected, or

Flaps are extended beyond 15, or
L NAV is disengaged without glideslope capture.

Proper MCP altitude selections ensure correct altitude alerting.

AUTOPILOT IN OPERATION

The modes of operation of the autopilot during the various flight phases can be seen from the following table:

PHASE	ROLL	PITCH	AUTOTHROTTLE
Take-off	TOGA	TOGA	THR REF
Climb	LNAV, HDG or VOR	FLCH SPD, VNAV or V/S	THR REF, SPD or MACH
Cruise	LNAV, HDG or VOR	ALT HOLD, VNAV	SPD or MACH
Descent	LNAV, HDG or VOR	FLCH SPD, VNAV or V/S	THR REF, SPD or MACH
Approach	LNAV, HDG or LOC	ALT, G/S, FLARE	SPD
Land	ROLLOUT		
Go Around	TOGA	TOGA	THR REF

OTHER AUTOPILOT FEATURES

Roll and Pitch Modes

Approach mode (APP) allows Localizer and Glideslope elements of the ILS system to be coupled to the roll and pitch channels of the autopilot to allow automatic control down to decision height, or to effect a fully automatic landing.

Control Wheel Steering (CWS)

A Control Wheel Steering mode (CWS) is provided in some automatic flight control systems (Boeing 737-400), its purpose being to enable the pilot to manoeuvre his aircraft in pitch and/or roll, through the automatic control system without disconnecting the autopilot. The signals for the A/P are produced by transducers in the control column.

Pressing a CWS engage switch, engages the A/P pitch and roll axes in the CWS mode and displays CWS P and CWS R on the FMAs.

With CWS engaged, the A/P manoeuvres the aeroplane in response to control pressures applied by either pilot. The control pressure is similar to that required for manual flight. When control pressure is released, the A/P holds existing attitude.

If aileron pressure is released with 6 degrees or less angle of bank, the A/P rolls the wings level and holds the existing heading. This heading hold feature with bank less than 6 degrees, is inhibited when any of the following conditions exist:

- Below 1500 ft RA with the landing gear down.
- After FD VOR capture with TAS 250 kts or less.
- After FD LOC capture in the APP mode.

Pitch CWS with a CMD Engage switch selected

The pitch axis engages in CWS while the roll axis is in CMD when:

A command pitch mode has not been selected or was de-selected
A/P pitch has been manually overridden with control column force. The force required for override is greater than normal CWS control column force. This manual pitch override is inhibited in the APP mode with both A/Ps engaged.

CWS P is annunciated on the Flight Mode Annunciators (FMA) while this mode is engaged. Command pitch modes can then be selected.

When approaching a selected altitude in CWS P with a CMD engage switch selected, CWS P changes to ALT ACQ and when at the selected altitude, ALT HOLD engages.

If pitch is manually overridden while in ALT HOLD the annunciator changes to CWS P. If control force is released within 250 ft of the selected altitude, CWS P changes to ALT ACQ and the A/P returns to the selected altitude and ALT HOLD engages. If the elevator force is held until more than 250 ft from the selected altitude, pitch remains in CWS P.

Roll CWS with a CMD engage switch selected

The roll axis engages in CWS while the pitch axis is in CMD when:

A command roll mode has not been selected or was de-selected.
A/P roll has been manually overridden with control wheel force. The force required for override is greater than the normal CWS control wheel force.

CWS R is annunciated on the FMA while this mode is engaged.

CWS R with a CMD engage switch illuminated, can be used to capture a selected radio course while VOR/LOC or APP mode is armed. Upon intercepting the radial or localiser, the FD and A/P annunciation changes from CWS R to VOL/LOC engaged and the A/P tracks the selected course.

Touch Control Steering (TCS)

Touch Control Steering (TCS) also permits a pilot to manoeuvre his aircraft in pitch or roll, but unlike CWS the appropriate automatic control channels and servo-motors are disengaged while the TCS button is held depressed while the pilot flies the aircraft to the desired attitude using manual control. The autopilot is re-engaged by release of the TCS button and the autopilot continues to again hold the aircraft in the attitude in which it was left.

Altitude Reference to Autopilot

The altitude selected in the window on the MCP is referenced to the Captain's barometric altimeter setting when the 'A' autopilot is selected and to the First Officer's when 'B' is selected. After ALT HOLD engages, changes in altimeter barometric settings do not change the selected altitude reference i.e. the autopilot will not change altitude until a new altitude is selected and engaged.

AUTOPILOT LIMITATIONS AND OPERATIONAL RESTRICTIONS**Autopilot Disengage Warnings**

The "A/P" light flashes red and a tone sounds when an autopilot has disengaged.

The warning can be reset by pressing either disengage light or either A/P disengage switch.

The A/P warning light stays at steady red if:

Stabiliser is out of trim below 800ft RA on a dual channel approach.

Altitude Acquire mode is inhibited during an A/P go-around. (stabiliser not trimmed for single A/P operation. See A/P Go-Around).

Disengage light test switch is held in position 2 (red filament test).

Automatic ground system test fail.

The light will illuminate a steady amber when the Disengage Light Test Switch is held in position 1 (amber filament test).

The light will flash amber if A/P automatically reverts to CWS pitch or roll while in CMD. The light will reset when either light is pressed or another mode is engaged.

Maximum Pitch and Bank Angles

During normal autopilot operation the maximum angles are:

Pitch $\pm 10^\circ$

Roll $\pm 30^\circ$

These limits are however not stipulated legally and will vary from aircraft to aircraft.

Gain Adaption

Variations in flight parameters such as altitude, speed, aircraft load, configuration and rate of manoeuvre, will have an effect on the handling characteristics of an aircraft. It is therefore necessary to incorporate 'gearing' elements within flight control systems which will adapt the parameters to the aircraft so that their effect on handling characteristics is reduced. In automatic systems the response is altered by changing the 'gain' of the system to a given level of input signal. This can be likened to changing gear ratios in a mechanical system.

Gain adaptation is particularly important for maintaining handling characteristics with changes in IAS during the different phases of flight and is similar to the gain scheduling in the flight director system.

Approach/Land mode

During an auto-land sequence the autopilot has to execute many important manoeuvres. These are described in the Auto-land notes.

FLIGHT MANAGEMENT SYSTEM

The autopilot can form part of the overall Flight Management System (FMS). This is may also be designated the Automatic Flight Control System (AFCS) or the Flight Management and Guidance System (FMGS). It provides manual or automatic modes of control throughout the entire flight envelope from take-off to landing and roll-out. All the subsystems of the FMS are fully integrated and have levels of redundancy to achieve a high level of reliability. Redundancy is accomplished by providing two or more systems of each type so a failure of one system will not affect the operation of the complete system.

The AFCS and FMS will be checked completely during the pre-flight checks. During these checks all the automated systems will be engaged, tested and their various safety devices tested. The FMS will be checked for the correct information and any additional information will be entered.

CHAPTER TWENTY EIGHT

AUTOLAND

Contents

INTRODUCTION 397

AUTOLAND SYSTEM. 397

THE AUTOMATIC LANDING SEQUENCE 398

APPENDIX 3A 402

ILS 402

WEATHER MINIMA 403

THE ICAO CATEGORISATION OF LOW VISIBILITY

LANDING CAPABILITIES 403

ALERT HEIGHT 404

INTRODUCTION

The approach and landing manoeuvre is the most difficult one demanded of a pilot in that it entails control of the aircraft in all three axes simultaneously as well as control of airspeed through engine power changes. The pilot has to:

- Align the aircraft with the runway centre-line
- Achieve a sinking rate of about 2 feet per second before touchdown
- Reduce the airspeed from 1.3 Vs to about 1.15 Vs by progressive reduction of engine power
- Level the wings before actual landing yaw the aircraft to remove any drift angle (drift “kick off” or de-crabbing).

An automatic landing system that takes over from a pilot must be able provide guidance and control better than that required of the pilot.

Autopilots have for a long time now been able to fly most of the approach allowing the pilot to concentrate on navigating the approach correctly. The pilot would then take over at decision height and continue to land manually. Aircraft that are fitted with all the equipment required for a fully automatic landing may, due to lack of required ground equipment for example or simply for pilot experience requirements, carry out an auto-approach. Essentially all the procedures are carried out as for an auto-land, but when decision height is reached the pilot will take over manually.

AUTOLAND SYSTEM

Objective

In order to achieve the objective of automatic landing, the operation of an automatic flight control system must be of such a nature that it will:

- Not disturb the flight path as a result of an active malfunction
- Have adequate authority for sufficiently accurate control along the required flight path
- Warn of a passive failure
- Allow the intended flight manoeuvre to be completed following an active or a passive failure.

Requirements

To enable an aeroplane to complete an automatic landing the auto-land system requires

- A minimum of **two independent autopilots** capable of following ILS signals
- Two independent **Radio Altimeters** to give accurate height from the ground information
- Category 3 ILS** ground installation at the airport.

Auto-land Status

The number of autopilots required also depends upon the auto-land status of the aircraft. These fall into two main categories:

Fail - passive (Fail-soft)

This is defined as the ability of the system to withstand a failure without endangering passenger safety, and without producing excessive deviations in the flight path but removing its capability to complete an automatic landing.

The minimum number of autopilots required for a fail-passive capability is two.

Fail-Operational (Fail - active)

This status is defined as the ability of a system to withstand a failure without affecting the overall functioning of the system and without causing degradation of performance beyond the limits required for automatic landing.

The system requires a minimum of three autopilots. However it is possible for an aircraft to have a fail operational category with only two autopilots provided that there is suitable duplicate monitoring for each channel.

THE AUTOMATIC LANDING SEQUENCE**Profile**

During cruise and initial stages of approach to land, the control system operates as a single channel system, controlling the aircraft about its pitch and roll axes, and providing the appropriate flight director commands. The profile of an automatic approach, flare and landing sequence is shown in Figure 3.1 and is based on a system that utilises triple digital flight control computer channels, allowing for redundancy to operate in the fail operational and fail passive conditions already defined.

Status Annunciator

Depending upon the number of channels that are armed and engaged, the system performs what are termed a '**LAND 2**' status or '**LAND 3**' status auto-land. Thus '**LAND 2**' signifies there is dual redundancy of engaged flight control computers, sensors and servos (**fail passive operation**) while '**LAND 3**' signifies triple redundancy of power sources, engaged flight control computers, sensors and servos (**fail operational**). Each status is displayed on an auto-land status annunciator.

Approach

Since multi-channel operation is required for an automatic landing, at a certain stage of the approach, the remaining two channels are armed by pressing an '**APPR**' switch on the flight control panel. The operation of this switch also arms the localiser and glide slope modes. Both of the 'off-line' channels are continually supplied with the relevant outer loop control signals and operate on a comparative basis the whole time.

Radio Altimeter

Altitude information essential for vertical guidance to touchdown is always provided by signals from a **radio altimeter** which becomes effective as soon as the aircraft's altitude is within the altimeter's operating range (typically 2500 feet).

AFS Radio Altimeter Loss

Two independent radio altimeters provide RA to the respective FCC. The Captain's radio altimeter also provides RA information to the A/T.

With a radio altimeter inoperative, do not use the associated FCC or the A/T, if affected, for approach and landing, i.e. failure of a single radio altimeter causes the auto-land system to fail passive.

The Sequence

An example of an auto-land sequence (for a Boeing aircraft) is described below.

Approach (APP) mode

The approach mode arms the AFDS to capture and track the localiser and glideslope. It can be engaged for dual or single pilot operation (auto-land with dual only). Dual autopilot (A/P) approach operation is described first.

Approach mode allows both A/Ps to be engaged at the same time. Dual A/P operation provides fail passive control through landing flare and touch down or an automatic go-around. During fail passive operation, the flight controls respond to the A/P commanding the least control movement.

One VHF Nav receiver must be tuned to an ILS frequency before the approach mode can be selected. For a dual A/P approach, the second VHF Nav receiver must be tuned to the ILS frequency and the corresponding A/P engaged prior to 800 ft RA.

Localiser and glideslope armed.

After setting the localiser frequency and course, pressing the APP switch selects the APP mode. The APP switch illuminates and VOR LOC and G/S armed is annunciated. The APP mode permits selecting the engagement of the second A/P. This arms the second A/P for automatic engagement after LOC and G/S capture and when descent below 1500 ft RA occurs.

The localiser can be intercepted in the HDG SEL, CWS R or L Nav modes. Either the LOC or G/S can be captured first (although it is most common to capture LOC the G/S).

Localiser Capture

The localiser capture point is variable and depends on the intercept angle and rate of closure, but does not occur at less than $\frac{1}{2}$ a dot deviation. Upon LOC capture, VOR LOC annunciates captured, 1 CH is annunciated for the A/P status, the previous roll mode disengages and the aeroplane turns to track the LOC.

Glideslope Capture

The G/S can be captured from above or below (although from below is generally preferred). Capture occurs at $\frac{2}{5}$ dot deviation. G/S annunciates captured, the previous pitch mode disengages, the APP switch light extinguishes if the localiser has also been captured, aeroplane pitch tracks the G/S and the annunciated N1 thrust limit for the A/T is GA.

After LOC and G/S are both captured the APP mode can be exited only by pressing the TOGA switch or by disengaging the A/P and turning off both FD switches or re-tuning a VHF Nav receiver.

After Localiser and Glideslope Capture

The A/Ps will disengage and the FD command bars will retract to indicate an invalid ILS signal.

At 1500 feet radio altitude (RA)

Shortly after capturing both LOC and G/S and descending below 1500 ft RA, the second A/P couples with the flight controls, FLARE mode armed is annunciated and the A/P go-around mode arms but is not annunciated. ROLL OUT mode if available will also now arm. The autoland status will also now be annunciated as either **“LAND 2”**(or **“LAND 3”** for fail operational aircraft).

The pitch and roll axes cannot be manually overridden into CWS. Attempts to do so will result in A/P disengagement.

800 ft RA

The second A/P must have been engaged by 800 ft RA to execute a dual A/P approach. Otherwise, engagement of the second A/P is inhibited on descending through 800 ft RA.

400 - 330 feet RA

The stabiliser is automatically trimmed an additional amount nose-up, with the elevators neutralising and holding the pitching up moment. If the A/Ps subsequently disengage, forward control column force may be required to hold the desired pitch attitude. This biasing aids the flare and in the event of a subsequent fail passive the aircraft will tend to pitch nose up to prevent a hard contact with the ground and aids the initiation of a go around.

If FLARE is not armed by approximately 350 ft RA, both A/Ps automatically disengage.

At 45 feet gear altitude (GA)/ 50 ft RA

The A/P flare manoeuvre starts at approximately 50 ft RA and is completed at touchdown. FLARE engaged is annunciated and the FD command bars retract. Also:

The stabiliser trim is again automatically trimmed an additional amount nose-up.

The **FLARE** mode is automatically engaged (replacing G/S) to give the aircraft a 2 feet/second descent path

The A/T begins retarding thrust at approximately 27 ft RA so as to reach idle at touchdown.

The **gear altitude** calculation, which is pre-programmed into the computer, is based upon radio altitude, pitch attitude, and the known distance between the landing gear, the fuselage and the radio altimeter antenna.

At about 5 feet GA:

The flare mode is disengaged and there is transition to the touchdown

LOC disengages

Roll-out mode (if available) will engage.

At about 1 foot GA:

The pitch attitude of the aircraft is decreased to 2°

At touchdown, a command signal is supplied to the elevators to lower the aircraft's nose and so bring the nose landing gear wheels in contact with the runway and hold them there during the **roll-out**.

When reverse thrust is applied the auto-throttle system is automatically disengaged.

Irrespective of reverse thrust deployment, the A/T automatically disengages approximately 2 seconds after touchdown.

The automatic flight control system remains on until manually disengaged by the flight crew, which is when the auto-land sequence is considered to be completed.

Other features of Auto-land**Runway Alignment**

Although the yaw channel has not been mentioned any auto-flight system capable of an auto-land must be capable of 'kicking off drift' prior to touchdown. This is known as **runway alignment** mode and will typically be armed at the same time as the flare mode and engaged at less than 100'. During the approach from 1500' the yaw channel will compute the difference between heading and track, when align mode engages the rudder deflects to align the aircraft with the runway centreline before touchdown. This manoeuvre is known as **de-crabbing**, or drift 'kick-off'.

Roll-out

Another function of Cat 3 auto-land systems is **roll-out** which gives steering commands on the ground proportional to localiser deviation along the centreline. These commands can show left/right steering guidance through a rotating 'barbers pole' indicator known as a para-visual display (PVD). Alternatively automatic steering can be achieved by applying deviation signals to the rudder channel and nosewheel steering to keep the aircraft on the centreline throughout the ground roll.

A/P Go-around Mode

The A/P go-around (GA) mode requires dual A/P operation and becomes armed when FLARE armed is annunciated. The A/P GA mode cannot be engaged before flare arm is annunciated or after the A/P senses touchdown.

Note: if the GA mode is selected after touchdown and prior to A/T disengagement, the A/Ps will disengage and the A/Ts may command GA thrust, with the procedure being flown manually.

Pressing either TOGA switch engages the GA mode and GA engaged is annunciated for the AFDS. The MCP IAS/Mach display becomes blank and the airspeed cursors are positioned at the AFDS commanded speed. Command airspeed is the flap manoeuvring speed.

A/P GA Pitch control

Upon GA engagement, the thrust levers advance toward the reduced GA N1. The A/P initially commands a 15 degree nose-up pitch attitude, and the airspeed cursors display manoeuvring speed for the flap setting. When a programmed rate of climb is established, the A/P controls pitch to hold airspeed based on the normal flap manoeuvring speed.

A/P GA Roll control

With the GA mode engaged, the A/Ps maintain the aeroplane ground track existing at GA engagement.

Leaving A/P GA mode

Below 400 ft RA, the A/Ps must be disengaged to change either pitch or roll modes from GA. Above 400 ft RA, other pitch and roll modes can be selected.

If the roll mode is changed first, the selected mode engages in single A/P roll operation and is controlled by the A/P which was first engaged. Pitch control remains in the dual A/P GA mode.

The pitch mode cannot be changed from GA until sufficient nose-down trim has been input to allow single A/P operation. This nose down trim is automatically added to reset the previous trim inputs that were applied automatically during the Auto-approach. If the pitch mode is the first to be changed from GA, the selected pitch mode engages in single A/P operation and is controlled by the first A/P that was engaged for the approach. The second A/P disengages and the roll mode changes to CWS R.

With pitch engaged in GA, ALT ACQ engages when approaching the selected altitude and ALT HOLD engages at the selected altitude if the stabiliser position is satisfactory for single A/P operation.

The transition from GA to ALT ACQ is normally successful if the selected altitude is at least 1000ft above the GA engagement altitude. A higher selected altitude may be required if full GA thrust is used.

If stabiliser trim is not satisfactory for single A/P operation, ALT ACQ is inhibited and the A/P disengage lights illuminate steady red and pitch remains in GA. To extinguish the A/P disengage lights, a higher altitude can be selected or the A/Ps disengaged.

Approach (APP) Mode / single A/P

A single A/P ILS approach can be executed by engaging only one A/P after pressing the APP switch. Single A/P approach operation is the same as for dual, with the following exceptions:

A/P status of 1 CH is annunciated for the entire approach after localiser capture.

Full automatic flare and touchdown capability is not available. FLARE is not annunciated and stabiliser trim bias is not applied.

An A/P GA is not available.

The following diagram shows an automatic landing, see if you can correctly fill in the pitch and roll armed and engaged modes in the annunciator boxes at each stage of the approach and landing. I've started you off at point A as Approach mode has been selected.

APPENDIX 3A

THE FOLLOWING NOTES ARE FOR GUIDANCE ONLY AND DO NOT FORM PART OF THE REQUIREMENTS FOR THE JAA EXAM.

ILS

An Instrument Landing System (ILS) is a short-range navigational aid which provides azimuth and vertical guidance during the approach to an airport runway. The system comprises ground-based transmitting elements and also receiving elements carried on board the aircraft.

The **ground-based** elements are:

- A localiser transmitter which sends runway azimuth approach information.
- A glide slope transmitter which provides vertical approach information.
- Marker beacons which transmit information about the distance to the runway threshold.

The **airborne** elements are:

- A localiser signal receiving antenna (usually the same antenna as the one used for the VOR).
- A glide slope signal receiving antenna.
- A dual ILS receiver installation.
- An indicator which shows whether the aircraft is on the correct approach path. Loc and GS deviation.
- A marker beacon antenna and receiver.
- Marker lights on the main instrument panel.

WEATHER MINIMA

In low visibility operations, the weather limits for landing are given in the following terms:

Runway Visual Range (RVR), which is an instrumentally derived value that represents the range at which high-intensity lights can be seen in the direction of landing **along the runway**. The measurements are transmitted to the air traffic controller who can inform the pilot of the very latest visibility conditions.

Decision Height (DH)

This is the wheel height above the runway elevation at which a go-around must be initiated by the pilot, unless adequate visual reference has been established, and the position and approach path of the aircraft have been visually assessed as satisfactory to safely continue the approach or landing.

Minimum values of DH and RVR are known as 'weather minima' and are specified by the national licensing authorities for various types of aircraft and airports. When the traffic controller advises that the RVR is above the specified minimum, the pilot may descend to the specified decision height and if, by then, he has sighted a sufficiently large segment of the ground to enable him to be confident of his judgement, he may carry on an land. He must otherwise overshoot, and either enter the holding pattern pending another approach, or divert to an alternative airport. During the approach, the pilot's line of sight is down the glide-path and not along the runway, and this gives rise to another factor, called '**slant visual range**', which a pilot must take into account in order to avoid misinterpretation of visual cues.

THE ICAO CATEGORISATION OF LOW VISIBILITY LANDING CAPABILITIES

All Weather Operations

The term 'all weather operations' is frequently used in connection with automatic landing systems and in describing low weather minima. This is a term which can, and sometimes is, taken to mean that there are no weather conditions that can prevent an aircraft from taking-off and landing successfully. This is not the case, because no automatic system can, for example, perform the landing task in wind conditions in excess of those for which the aircraft has been certified, this being primarily governed by the controllability characteristics and strength factors of the aircraft. Similarly, no automatic system can land an aircraft on a runway which has a surface which is not fit for such an operation because of contamination by water, slush or ice.

Category of Operation

The definitions of the main categories are illustrated in Figure 3.3.

The three categories also serve as an indication of the stages through which automatic approach and automatic landing development progress, and thereby designate the capabilities of individual automatic flight control systems. In addition, they designate the standards of efficiency of the ground guidance equipment available at airports, namely ILS localiser and glide path, and approach, runway and taxi-way lighting.

Category 1

A precision instrument approach and landing with a decision height no lower than 60 m (200 ft), and with either a visibility not less than 800 m, or a runway visual range not less than 550 m

Category 2

A precision instrument approach and landing with decision height lower than 200 ft but not lower than 100 ft, and a runway visual range not less than 300 m.

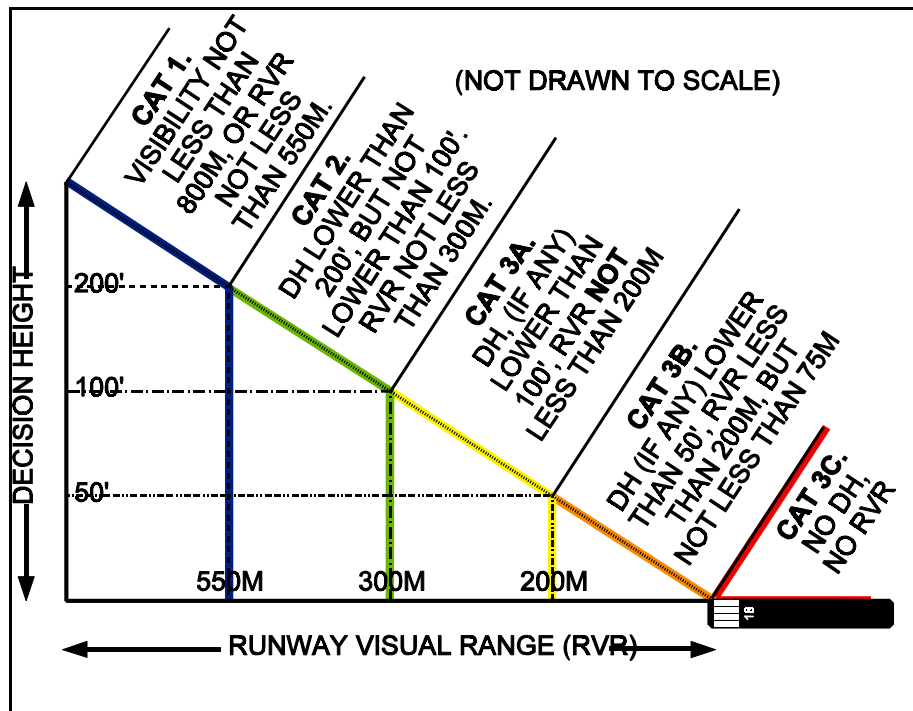

Figure 28.1 Categories of Low Visibility Landing Capabilities

Category 3A

A precision instrument approach and landing with a decision height lower than 100 ft and a runway visual range not less than 200 m.

Category 3B

A precision instrument approach and landing with a decision height, if any, lower than 50 ft and a runway visual range less than 200 m but not less than 75m.

Category 3C

To and along the surface of the runway and taxi-ways without external visual reference.

ALERT HEIGHT

The alert height is a specified radio height, based on the characteristics of the aircraft and its **fail-operational** landing system. In operational use, if a failure occurred **above** the alert height in one of the required redundant operational systems in the aircraft the approach would be discontinued and a **go-around** executed, unless reversion to a higher decision height is possible. If a failure in one of the required redundant operational systems occurred **below** the alert height, it would be ignored and the **approach continued** to complete the auto-land.

CHAPTER TWENTY NINE

AUTOTHROTTLE

Contents

INTRODUCTION407
AUTO-THROTTLE SYSTEM407
THRUST COMPUTATION413
FADEC.413

INTRODUCTION

An auto-throttle system is a computer controlled, electro-mechanical system which can control the thrust of an aircraft's engines within specific design parameters. The throttle position of each engine is controlled to maintain a specific value of thrust in terms of:

- Fan Speed (N1)
- Engine Pressure Ratio (EPR) or
- Target Airspeed (set by SPD on mode control panel)

Thrust is the **force** generated by the engines. The throttles control the thrust and in some aircraft the preferred name for the throttles is thrust levers. It is worth noting that although there are thrust computation systems there is, as yet, no direct indicator of thrust value in use. Instead N1 and EPR are used to indicate a measure of engine thrust.

Using the above modes the auto-throttle can control aircraft speed from the beginning of the take-off roll until the system is disconnected after an automatic landing. (See Figure 29.1).

AUTO-THROTTLE SYSTEM

System Components

The Auto-throttle can also be called the Thrust Management System (**TMS**) that works in conjunction with the autopilot and the FMS.

Figure 29.1 shows a basic auto throttle system and signal interfacing between various aircraft systems and sensors.

Inputs

These would include:

- Mode selection and A/T Arm switch on the MCP
 - TAS, Mach No and TAT from the ADC
 - Attitude and acceleration from the IRS
 - N1 speed and/or EPR from engine sensors
 - Angle of attack from AoA sensor
 - Radio altitude from the radio altimeter
 - Air / ground logic from the landing gear switch
 - Reverse thrust requirement from the engine accessory unit
- Plus**
- Thrust command from the FMS or thrust mode selection from the thrust mode select panel
 - A/T disconnect switch on the throttles
 - PLA (power lever angle) position from transducers
 - Flap position.

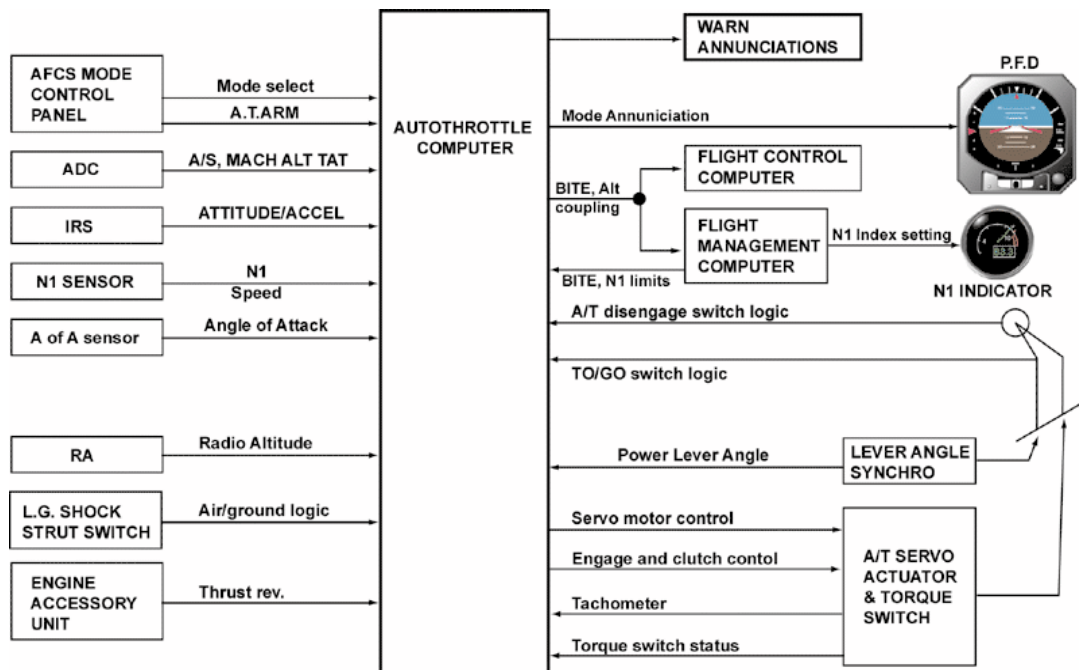

Figure 29.1

Outputs

The main outputs from the system would be signals to:

- A/T servo-actuator to move the throttles
- A/T disengage circuit
- BITE (built in test equipment) circuits in the FCC and the FMC
- Mode annunciation to the EFIS symbol generator
- Thrust limits and to the EICAS / ECAM display
- Failure warnings annunciations (lamp and/or aural, electronic display).

Feedback

The auto-throttle system compares the actual values with reference values and passes control signals to the servo-motors of the thrust levers. In order to control the speed at which the thrust levers are moved there is a suitable feedback from the servo actuators to the TMC.

Boeing 737-400 General

The A/T system provides automatic thrust control from the start of the takeoff through climb, cruise, descent, approach and go-around or landing. In normal operation, The FMC provides the A/T system with N1 limit values.

The A/T moves the thrust levers with a separate servo-motor on each thrust lever. Manually positioning the thrust levers does not cause A/T disengagement unless 10 degrees of thrust lever separation is exceeded during a dual channel approach after FLARE armed is annunciated. Following manual positioning, the A/T may reposition the thrust levers to comply with computed thrust requirements except while in the HOLD and ARM modes.

Power Management Control (PMC)

The thrust control system consists of a hydro-mechanical MEC unit and a PMC unit mounted on each engine. The PMC in an electronic system with limited authority over the MEC. The Main Engine Control (MEC) schedules fuel to provide the thrust called for by the Forward

Thrust Lever setting on the flight-deck. This fuel flow is further refined electronically by the Power Management Control (PMC) without moving the thrust levers.

The PMC uses MEC power lever angle, N1 speed, inlet temperature and pressure to adjust, or trim, the MEC to obtain the desired N1 speed. The PMC adjusts fuel flow as a function of thrust lever angle.

The PMC provides a constant thrust climb feature once the thrust lever is set at the beginning of climb. Thus, when thrust is set for climb, the PMC automatically maintains that thrust throughout the climb profile with no further thrust lever adjustments. If the thrust lever is repositioned, the PMC maintains the setting corresponding to the new thrust lever angle.

The PMC includes failure detection and annunciation modules which detect PMC failures and provide a signal to the crew. For detectable failure conditions, the PMC schedules a slow N1 drift over approximately 30 seconds and then illuminates the PMC INOP Light, the ENG System Annunciator Light and the MASTER CAUTION Lights. For a PMC failure, the PMC can be selected OFF by a switch on the aft overhead panel. The engine speed is then controlled by the hydro-mechanical MEC only. The PMC INOP light is suppressed below starter cutout engine speed.

A/T - PMC Operation

The A/T system operates properly with the PMCs ON or OFF. In either case, the A/T computer controls to the FMC N1 limits.

During A/T operation, it is recommended that both PMCs be ON or both OFF, as this produces minimum thrust lever separation. A/T takeoffs may be performed with both PMCs OFF.

A/T Engagement and Disengagement

Moving the A/T Arm Switch to ARM, arms the A/T for engagement in the N1, MCP SPD or FMC SPD mode. The A/T Arm Switch is magnetically held at ARM and releases to OFF when the A/T becomes disengaged.

Any of the following conditions or actions disengages the A/T:

- Moving the A/T Arm switch to OFF.
- Pressing either A/T disengage switch.
- An A/T system fault is detected.
- 2 seconds have elapsed since landing touchdown.

Thrust levers become separated more by than 10 degrees during a dual channel approach after FLARE is annunciated.

A/T disengagement is followed by A/T Arm Switch releasing to OFF and the A/T Disengage Light flashing red.

The A/T Disengage lights can be extinguished by any of the following actions:

- Returning the A/T Arm Switch to ARM
- Pressing either A/T Disengage light
- Pressing either A/T Disengage Switch

The A/T Disengage lights do not illuminate when the A/T automatically disengage after landing.

Take Off Mode

The Takeoff mode is engaged by pressing either TOGA Switch with the aeroplane on the ground, the A/T armed and the desired takeoff N1 thrust limit selected from a FMC CDU. The A/T annunciation changes from ARM to N1 and the thrust levers advance toward take-off thrust.

The A/T sets takeoff thrust. THR HLD annunciates at 84 kts (64 kts for aeroplanes with earlier model A/T computers) to indicate that the A/T cannot change thrust level position, but thrust levers can be repositioned manually.

After liftoff, the A/T remains in the THR HLD until 400 ft RA is reached and approximately 18 seconds have elapsed since liftoff. A/T annunciation then changes from THR HLD to ARM. Reduction to climb thrust can now be made by pressing the N1 switch.

Until 2½ minutes after liftoff, automatic reduction to climb thrust is inhibited when in LVL CHG or V/S mode. If V NAV, ALT ACQ or ALT HOLD is engaged during this 2½ minute period, automatic thrust reduction occurs normally.

N1 Mode

The A/T maintains thrust at the N1 limit selected from a FMC CDU. N1 is annunciated for the A/T and the N1 switch illuminates. Pressing the N1 switch changes the A/T mode from N1 to ARM.

If an engine fails while the A/T is in the N1 mode, the thrust lever of the failed engine will advance forward a few degrees and then return to or below the other thrust lever position.

Speed Mode

The speed mode is available throughout the flight once the takeoff phase is completed. Pressing the MCP Speed Select Switch selects the speed mode if compatible with the engaged AFDS pitch mode. MCP SPD is annunciated for the A/T mode and the Speed Mode Switch illuminates. The speed or Mach shown in the MCP IAS/MACH Display is the target speed. The A/T will not set power above the displayed N1 limit, however, the A/T can exceed an N1 value that has been manually set by the N1 manual set knob. If an engine fails while the A/T is in a speed mode, both thrust levers advance together to maintain the target speed.

When on final approach in landing configuration, it is not recommended to set the A/T command speed to allow for wind or gust corrections. Through airspeed and acceleration sensing, the A/T corrects for normal wind gusts. Higher command speed settings result in excessive approach speeds. The recommended A/T approach speed setting is VREF +5.

Below 400 ft RA, A/T thrust level response rate and engine power levels are sufficient to place the engines in the rapid acceleration range.

FMC Speed Mode

The FMC SPD mode is an A/T mode which is commanded by the FMC during V NAV operation. When engaged, the MCP IAS/Mach display is blank, the airspeed cursors are positioned at the FMC commanded airspeed and the A/T maintains this commanded speed. The A/T is limited to the N1 value shown on the thrust mode annunciators.

N1 Equalization

The A/T attempts to equalize N1 through the dual servo individual thrust lever control. Equalization control is limited to 8 degrees of thrust lever separation.

ARM Mode

The A/T annunciates ARM when the A/T Arm Switch is at ARM and no A/T mode is engaged. The thrust levers can be manually positioned without interference from the A/T system while ARM is annunciated.

The A/T automatically transfers to ARM from the SPEED or N1 mode when the mode is deselected by pressing the respective Mode Selector Switch while the switch light is illuminated.

Descent Retard Mode

The A/T engages and annunciates RETARD during LVL CHG and V NAV descents. RETARD changes to ARM when the thrust levers reach the aft stop or when they are manually prevented from reaching the aft stop.

Landing Flare Retard Mode

During landing, The RETARD mode engages, reduces thrust and annunciates RETARD 2 ½ seconds after FLARE mode engagement or at 27 ft RA, whichever occurs first. During a non-precision or visual approach with flaps extended to 15 or greater and the AFDS not in ALT ACQ or ALT HOLD, the A/T RETARD mode engages at 27 ft RA. The A/T automatically disengages approximately 2 seconds after landing touchdown.

Go-Around Mode

With the A/T Arm Switch at ARM, the A/T go-around mode is armed when descending below 2000 ft RA, with or without the AFDS engaged. Once armed, the A/T go-around mode can be engaged until 2 seconds have elapsed after landing touchdown.

Pressing either TO/GA Switch engages the A/T go-around mode. GA is annunciated for the A/T and the thrust levers advance to the reduced go-around thrust setting. This setting produces a 1000 to 2000 fpm rate of climb. After reaching reduced go-around thrust, pressing either TO/GA Switch the second time signals the A/T to advance thrust to the full go-around N1 limit.

After reaching reduced or full go-around thrust, the A/T GA mode can be terminated by selecting another AFDS pitch mode or when ALT ACQ annunciates engaged.

During a single engine FD go-around, the A/T will increase thrust to the full N1 limit.

Auto-throttle Disengage Switches

Pressing an Auto-throttle Disengage Switch disengages the auto-throttle (A/T). The A/T disengage light flashes and the A/T ARM switch on the MCP trips off. Pressing the Auto-throttle Disengage Switch a second time extinguishes the A/T warning.

After an automatic A/T disengagement pressing the Auto-throttle Disengage Switch will extinguish the A/T warning.

Auto-Throttle Disengage Light

The A/T Disengage Light will flash red if the A/T disengages for any reason.

The A/T Disengage Light will illuminate steady red when the Disengage Light Test Switch is held in position 2 (red filament test position) and steady amber when the Disengage Light Test Switch is held in position 1 (amber filament test position).

The A/T Disengage Light flashing amber indicates an A/T airspeed error if speed is not held within +10 or -5 knots of the commanded speed when all of the following conditions exist:

- In flight
- Flaps not up
- A/T engaged in MCP SPD, or FMC SPD mode

An automatic test of the A/T flashing amber function is performed if the A/T is engaged and the following conditions exist:

- MCP SPD or FMC SPD is the active A/T mode
- More than 150 seconds after liftoff
- Flaps extended

The A/T amber light flashes for 2 seconds, remains extinguished for 2 seconds and then flashes for 2 seconds again.

Thrust Mode Annunciator Panel (TMA)

On the Boeing 737-400 the Thrust Mode Annunciator panel is located on the centre instrument panel, above the N1 RPM indicators. It displays the active N1 limit reference mode for auto-throttle and manual thrust control. N1 limits are also displayed on the N1 RPM indicator cursors with the reference knobs pushed in.

N1 limits are normally calculated by the FMC. When FMC N1 limit calculations become invalid, or if either engine N1 is less than 18%, A/T LIM is annunciated. The auto-throttle computer then calculates a single N1 limit for the affected engine(s).

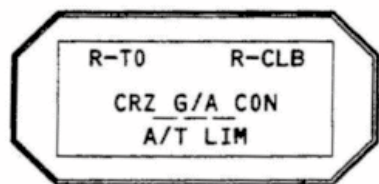

CENTER INSTRUMENT PANEL

R - Reduced. Can appear with T0 and CLB.
 T0 - Takeoff.
 CLB - Climb.
 CRZ - Cruise.
 G/A - Go-around.
 CON - Continuous.
 --- FMC is not computing thrust limits.

A/T LIM - Autothrottle limit. Indicates that A/T computer is calculating a degraded N1 limit for the affected engine or engines.

Flexible Take-Off

In situations where take-off can be executed without the need for full engine power (such as light weight takeoff from a long runway), then reduced power may be used, thereby reducing engine wear and increasing their life. This is called the Flexible take-off mode (and in the Airbus aircraft there is a detent position for the thrust levers labelled FLEX TO). The most basic way to achieve the reduced thrust is to manually set a lower RPM setting. To achieve a reduced power setting with the auto-throttle we can select a temperature on the control panel that is higher than the ambient airfield temperature. This causes the thrust computation system to calculate a lower limiting EPR or N1, thereby producing reduced power for the take-off.

THRUST COMPUTATION

Thrust

Engine thrust is a **force** which when multiplied by TAS will give us engine **power**.

Thrust = mass × acceleration.

In order to calculate thrust we need to establish the mass of air flow through the engine (M) and the change in velocity between the inlet and outlet of the engine ($V_o - V_i$). In practice other parameters are measured and the thrust obtained by computation. This process is carried out by the thrust computation system.

Thrust computation

The primary thrust parameter is EPR which is the ratio between the pressures at the compressor intake and the turbine outlet or exhaust. If EPR is not available then N1 (fan speed) is used to compute the thrust. The thrust lever is therefore used to select a value of EPR or N1.

In the auto-thrust mode (A/THR) the thrust is computed by the flight management and guidance system (FMGC) and is limited to the value corresponding to the thrust lever position. Most modern engines include an electronic control system that manages engine power throughout the flight. This is called FADEC.

Thrust rating Limit

The thrust rating limit for the engines for the various phases of flight are determined by a thrust rating limit computer.

FADEC

The system example comes from the Airbus series of aircraft.

Function

FADEC stands for full authority digital engine control. It provides complete engine management throughout all phases of flight and performs the following functions:

- Gas generation control (fuel flow, acceleration/deceleration, variable bleed valve and variable stator vane schedules, turbine clearance control, idle setting)
- Engine limit protection (over-speed N1 and N2)
- Power management (control of engine thrust rating, computation of thrust parameter limits, auto-thrust system demand, thrust lever position manual demand)
- Automatic engine starting sequence (control of start valve, fuel, ignition, monitoring N1, N2, FF, EGT)
- Manual engine starting sequence (passive monitoring of start valve, fuel, ignition, N1, N2, FF, EGT)

In performing its functions it takes into account such variables as power demanded, air bleed for air conditioning and de-icing, temperature, static pressure and engine accessory selection.

Advantages

The FADEC system reduces crew workload, provides engine limit protection, improves engine life and saves fuel and maintenance down time.

Components

FADEC consists of an electronic engine control (EEC) plus a fuel metering unit, sensors and peripheral units. There are suitable Interface circuits between the EEC and its peripheral units. There are 2 FADEC channels per engine, one in control and one in standby for redundancy. Each channel is powered by the aircraft's A/C supply before and during the initial start and then by an individual internal magnetic alternator above 12% engine RPM.

Thrust control is provided by a FADEC dedicated to each engine. Thrust selection is achieved by means of the thrust levers when in manual mode or the Flight Management and Guidance System (FMGS) when in automatic mode. Thrust rating limit is provided by the FADEC according to the thrust lever position both for manual and automatic thrust.

Fuel Control

In addition to the high pressure fuel pumps and shut off system there are again 2 main systems controlling engine performance. The Hydro-Mechanical Unit (HMU) is modulated by the FADEC. It provides control of fuel flow to the combustion chamber, control of fuel hydraulic signals to actuators, and over-speed protection.

The Fuel Metering Valve (FMV) transforms FADEC orders through a torque motor / servo valve into fuel flow to the engine nozzle. The FMV resolver provides an electrical feedback signal proportional to the FMV position. The by-pass valve regulates a constant pressure drop across the FMV to ensure that metered fuel flow is proportional to FMV position.

The FADEC computes fuel flow necessary to hold the target N1. To obtain this N1, the N2 is allowed to vary without exceeding N2 min and N2 max. The FADEC will also vary N2/N1 in order to maintain RPM under varying load conditions, maintain bleed air production, avoid engine stalls or flameout. With the Airbus FADEC it even modulates the cooling airflow around the engine in order to expand or contract the casing to control the compressor and turbine clearances at nominal settings.

Thrust Levers

The thrust levers are only moved manually (unlike many other auto-throttle systems). They move over a sector which is divided into 4 segments defined by 5 detents or stops. Thrust lever position is transmitted to the FADEC which computes and displays the thrust rating limit and the N1 TLA. Note that there is no reverse idle detent. When the idle stop is cleared by pulling up the reverse thrust levers, reverse idle is selected.

Thrust Rating Limit

Thrust rating limit is computed according to the thrust lever position. If the thrust lever is set in a detent the FADEC will select the rating limit corresponding to this detent. If the lever is set between 2 detents the FADEC will select the rating limit corresponding to the higher mode.

Thrust Control:**Manual Mode**

The engines are in the manual mode provided that the ATS function is:

Not armed

Armed and not active (thrust lever is not in the ATS operating range and/or no alpha floor condition)

In these conditions, each engine is controlled by the position of the corresponding thrust lever. Thrust modulation is performed by the pilot moving the thrust lever from IDLE to TO/GA position. Each position of the thrust lever within these limits correspond to a N1. When the thrust lever is positioned in a detent, the corresponding N1 is equal to the N1 rating limit computed by the associated FADEC.

When the thrust lever is set in the FLX-MCT detent:

On the ground: When the engine is running, the flex TO thrust rating is selected provided a flex TO temperature greater than the current TAT has been selected through the MCDU. Otherwise the MCT thrust is selected.

After TO

A change from FLX to MCT is achieved by setting the thrust lever to TO/GA or CL position and then back to MCT. After that FLX rating setting is not possible.

MAX TO power is always available by pushing the thrust lever fully forwards.

Automatic Mode

In the auto-thrust mode (A/THR function active), the thrust is computed by the FMGC and is limited to the value corresponding to the thrust lever position (except if the alpha floor mode is activated).

Inputs

- Air data parameters from the air data inertial reference system.
- Operational commands from the engine interface unit (target N1)
- Thrust lever angle (TLA)
- Engine Pressure sensors (N1 and N2)
- Temperature (EGT)
- Fuel flow.

Outputs

- Data outputs necessary for the FMGS
- Thrust parameters and TLA to the FMGS
- Control signals to the fuel metering unit
- Command N1 to the ECAM display.

CHAPTER THIRTY

YAW DAMPERS

Contents

DUTCH ROLL 419

FUNCTION OF A YAW DAMPER 419

THE YAW DAMPER 421

DUTCH ROLL FILTER 421

RUDDER CONTROL COMPUTING AUTHORITY 422

THREE AXIS AUTOPILOT WITH SERVO MOTOR 423

RUDDER CONTROL SYSTEM SCHEMATIC (Boeing 727) 427

EXAMPLE OF SEPARATE YAW DAMPER AND MAIN ACTUATOR 430

EXAMPLE OF A DUPLEX YAW DAMPER SYSTEM 433

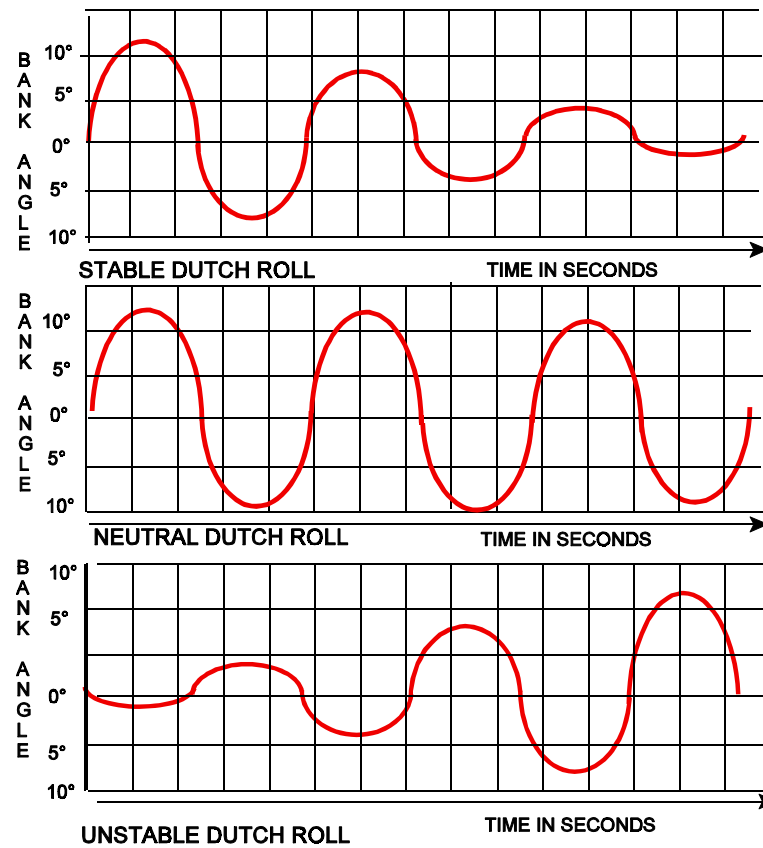

Figure 30.1 Dutch Roll Stability

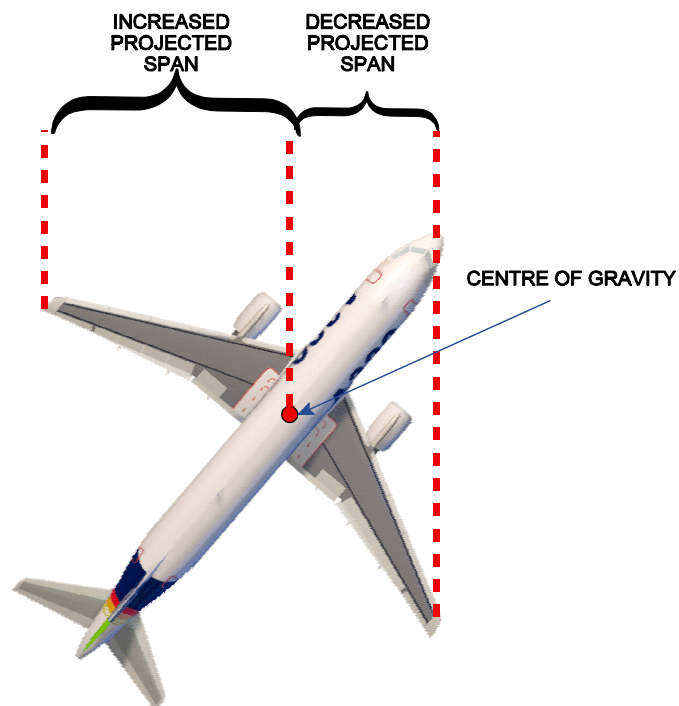

Figure 30.2 Change in Effect Aspect Ratio with Yaw

DUTCH ROLL

Dutch roll is caused by the interplay between lateral stability around the longitudinal axis (roll) and longitudinal stability around the vertical axis (yaw) of an aircraft in flight. An aircraft with an excess of lateral stability will by default have poor directional stability and therefore will be susceptible to dutch roll.

More simply, any disturbance of an aircraft in yaw directly causes a secondary disturbance in roll and visa versa. Stability is determined as the aircraft's natural tendency to resist and counter these disturbances to return to the same conditions as before the perturbation. If the relative stabilities in yaw and roll are in a particular range of proportions to each other, Dutch Roll can be the effect.

Consider an aircraft disturbed by a gust causing it to yaw. As the aircraft yaws one wing will travel slightly faster through the surrounding air and the other wing will travel slightly slower. The fast wing will produce slightly more lift than before and the slower wing will produce slightly less. This obviously will produce a roll.

As lift increases then lift induced drag will increase so the faster, higher wing will produce more drag and the low wing will produce less. This causes a yawing moment in opposition to the initial disturbance and the whole process is reversed.

Swept wing further exasperate the tendency for dutch roll because the forward going wing undergoes a reduction in effective wing sweep, further increasing the lift it produces, while the retreating wing experiences an increase in effective wing sweep, again reducing its lift.

All airline aircraft will be statically stable, in that they will naturally try to return to the undisturbed condition. Whether or not they are dynamically stable depends on the amount of damping force available. This is produced by the stabilizing aerodynamic surfaces in the main. As an aircraft climbs however its true air speed must increase to maintain the lift pressure. This increase in TAS means that the relative angle of attack for the aerodynamic surfaces is reduced for the same given disturbance, and so the corrective force supplied by that surface is reduced, so the damping effectiveness is reduced at high altitude.

FUNCTION OF A YAW DAMPER

To increase the damping forces at altitude could mean an increase in the overall size of the stabilizing surfaces but this would also increase drag. Another option is to produce an aircraft that is dynamically stable at lower and middle altitudes and have a system to automatically counter dutch roll which can detect the start of the oscillations at levels below the threshold of the pilots ability to detect and with rapid, effective rudder deflections, stopping the dutch roll almost before it starts. This system we call a **Yaw Damper**.

The number of yaw dampers fitted depends on how stable the aircraft is. If the dutch roll is easy for the pilot to control (it is not diverging quickly and the frequency of oscillation is reasonably large) then only one yaw damper may be required. Large, modern, airliners generally have poor dutch roll characteristics and so tend to have 2 and even 3 yaw damper systems, because a failure of all the systems may well limit the altitude at which the aircraft can operate to one suitably low to increase the damping forces available and reduce the tendency for dutch roll to start.

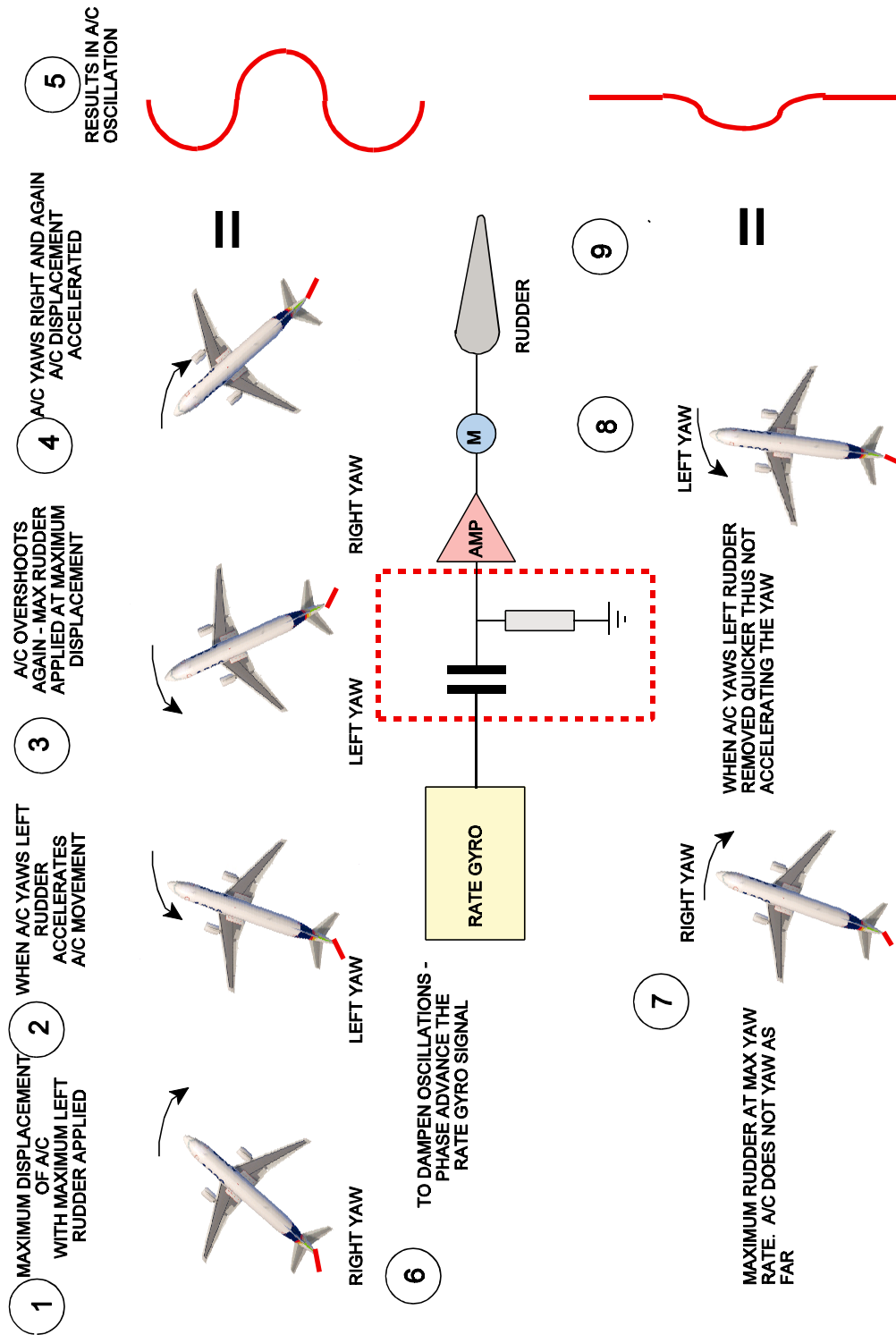

Figure 30.3 Principle of Phase Advance

THE YAW DAMPER

Typical Yaw Damping Signal Processing

Sensing

Sensing of a disturbance in yaw is usually by a rate gyro, though some systems may employ an accelerometer. The objective being to sense the yawing motion as quickly as possible and produce a correcting signal / demand to the servo/actuator which then feeds signals to the rudder control system to apply rudder in opposition to that yaw.

Phase Advance

Is means of applying the damping application as soon as possible. The reason for this is that damping must be applied when the **rate of disturbance** is at its greatest, not when the disturbance has moved to the point where the natural stability of the fin has arrested the disturbance. If a rudder application is applied at the same instant the fin starts to return the aircraft, both the combined forces will over correct and cause the aircraft to overshoot. Figure 30.3 tries to explain the ideal damping required.

Figure 30.3 shows a typical phase advance of the signal by 90°. It can be seen that it is nothing more than a capacitor and resistor connected to form a differentiator. The output of a differentiator is a rate signal. Therefore, if the input to the phase advance is a yaw rate, the output must be rate/rate, which is acceleration. The circuit has effectively accelerated the yaw signal to provide the rapid damping the system requires.

DUTCH ROLL FILTER

The system as described, however, would also interpret a normally commanded turn as a yaw and act in opposition to produce an uncoordinated turn (in fact the rudder would be exacerbating the coordination problem by introducing the full amount of its rudder authority in the opposite direction to that required). So the Yaw Damper system needs to be able to distinguish commanded turn inputs from yaw due to a disturbance or apparent dutch roll.

When an aircraft is turned, the aircraft rolls about the longitudinal axis in the direction of the turn and also YAWS about the vertical axis. A yaw damper is provide to dampen dutch roll, not to prevent the aircraft following a turn command. Therefore only the dutch roll frequency must be acted upon by the yaw damper.

The dutch roll frequency is based on the natural yawing frequency of the aircraft. The frequency is relatively LOW and will differ slightly with aircraft type. Typical valued being 0.2hz – Bae 1-11, 0.4Hz - Boeing 747.

Yaw dampers must be designed to allow the dutch roll frequency to control the rudder but block other frequencies. Figure 30.5 illustrates a typical dutch roll filter and circuit action.

Initially, while the rate of turn is building up to the constant rate, the dutch roll filter output also builds, then falls off to nothing when the rate of turn becomes constant. The reverse, with opposite polarity as the filter capacitor discharges, occurs as the aircraft levels out on completion of the turn. Therefore, whilst the turn is constant the filter output is zero. This results in no rudder demand.

Figure 30.4 shows an aircraft yawing at the dutch roll frequency. Since the rate of turn is the constantly changing, the output from the rate gyro is constantly changing. The D.C. graph at the bottom of Figure 30.4. is the dutch roll filter output.

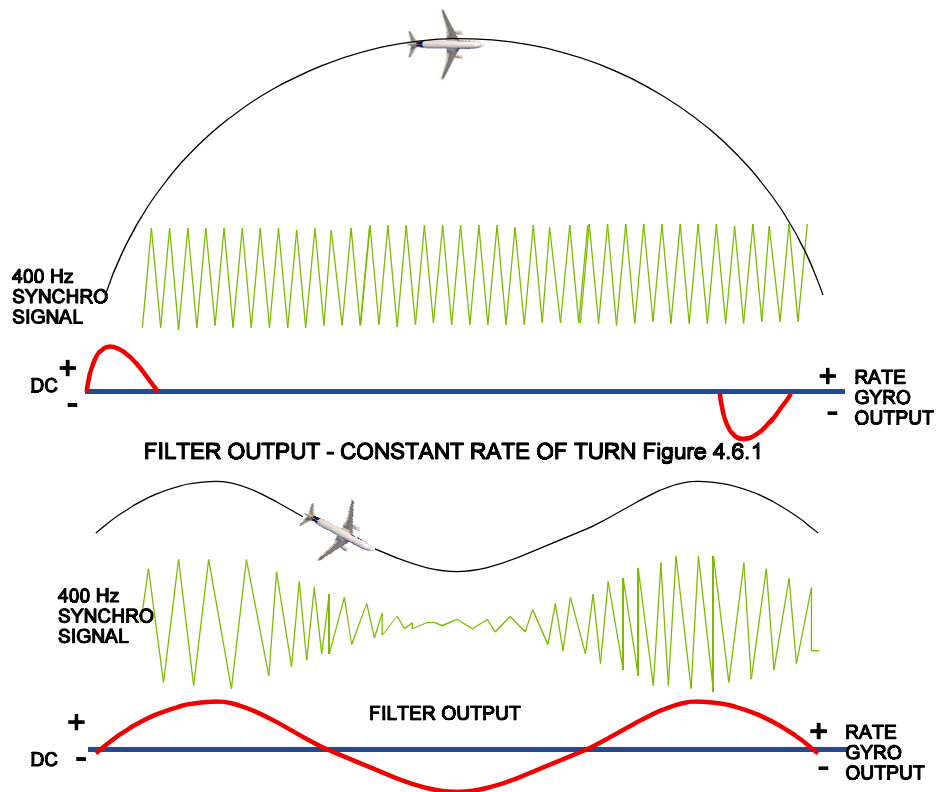

Figure 30.4 Filter Output - Dutch Roll

The D.C. polarities are the greatest when the rate of turn is the greatest and reverse when the direction of turn (rate of gyro signal) reverses.

Figure 30.5 is a super simplified yaw damper, illustrating mainly dutch roll filter. The dutch roll filter is a NARROW BAND PASS FILTER designed to pass only signals which change the frequency of the dutch roll. The rate gyro produces outputs for all turns, but only those related to dutch roll will appear at the input to the servo amplifier driving the rudder servo motor.

RUDDER CONTROL COMPUTING AUTHORITY

As removal of oscillations does not require a large rudder movement and to reduce the hazard posed by a yaw damper runaway, yaw damper authority is normally only about 3-6 degrees left and right of centre. If 2 yaw damper systems are operating on a single span rudder their authority is accumulative, i.e. singly each system could move the rudder by 3 degrees, together they can move it by 6 degrees.

On aircraft with a split rudder surface, if one yaw damper system fails then the aircraft has only $\frac{1}{2}$ the yaw damper protection that it originally had. This is allowed for in the design and operation of the aircraft. As even this small input may cause over-stress in certain flying conditions, some aircraft have an input to the yaw damper computer from the CADC to schedule the gain of the yaw damper inputs for the ambient flying conditions. At high speed therefore the yaw damper authority may be even further reduced to avoid an over-stress condition.

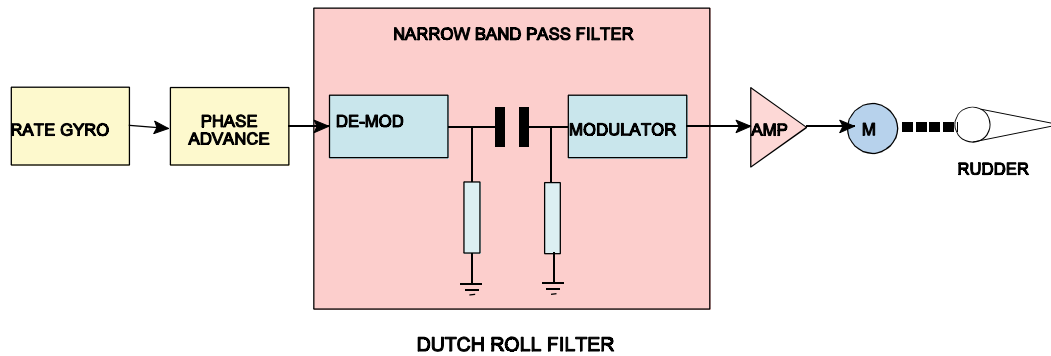

Figure 30.5 Basic Yaw Damper Showing Dutch Roll Filter

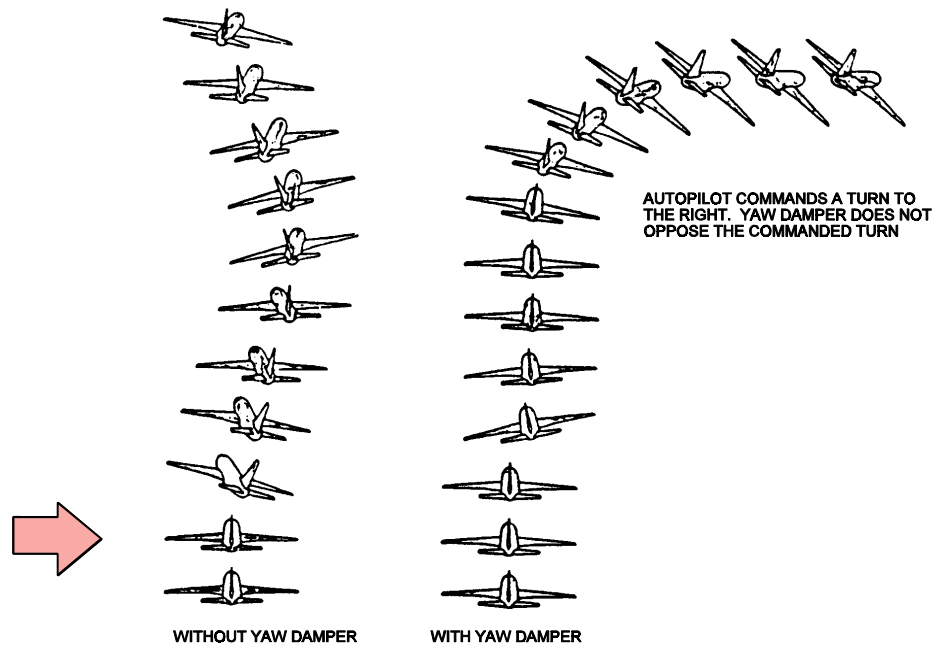

Figure 30.6 Yaw Damper Effect in a Commanded Turn

THREE AXIS AUTOPILOT WITH SERVO MOTOR

Engagement

Prior to engagement, the rudder signal chain is earthed and the rudder servo, which is disconnected from the rudder control runs, synchronises to the null position. Refer to Figure 30.7 for circuit description. On engagement, 29.5V AC is connected to the rudder servo clutch. At the same time, a rudder engage thermal relay operates and energises a rudder engage relay to connect filtered bank demand signal from the aileron channel to the rudder servo loop. The half second delay between energising the rudder servo clutch and operating the rudder engage relay permits a transient free engagement. Any yaw rate which then develops, produce a rudder deflection which tends to oppose the yaw rate.

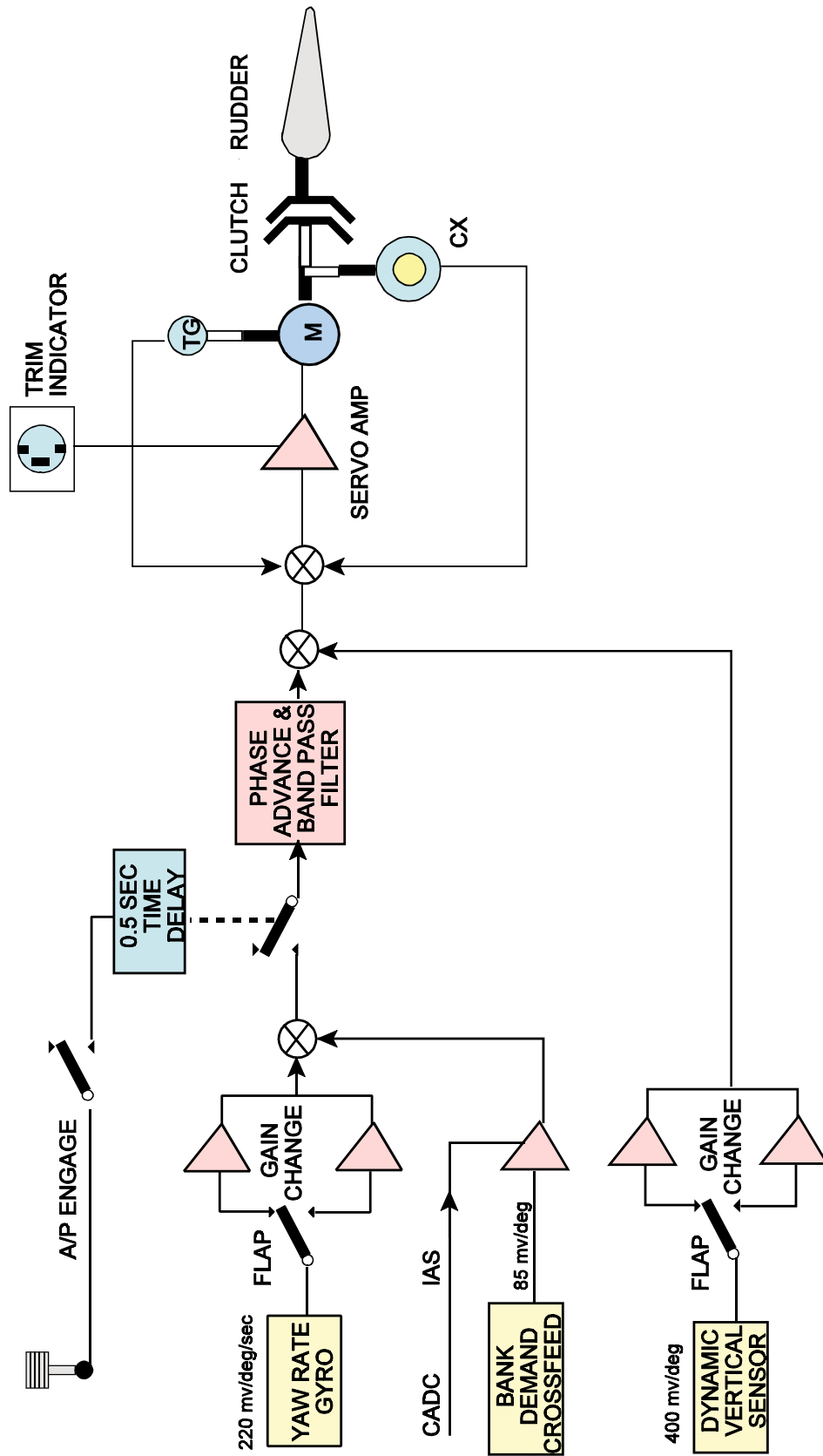

Figure 30.7 Three Axis Autopilot - Rudder Channel - Elliot E2000Ap

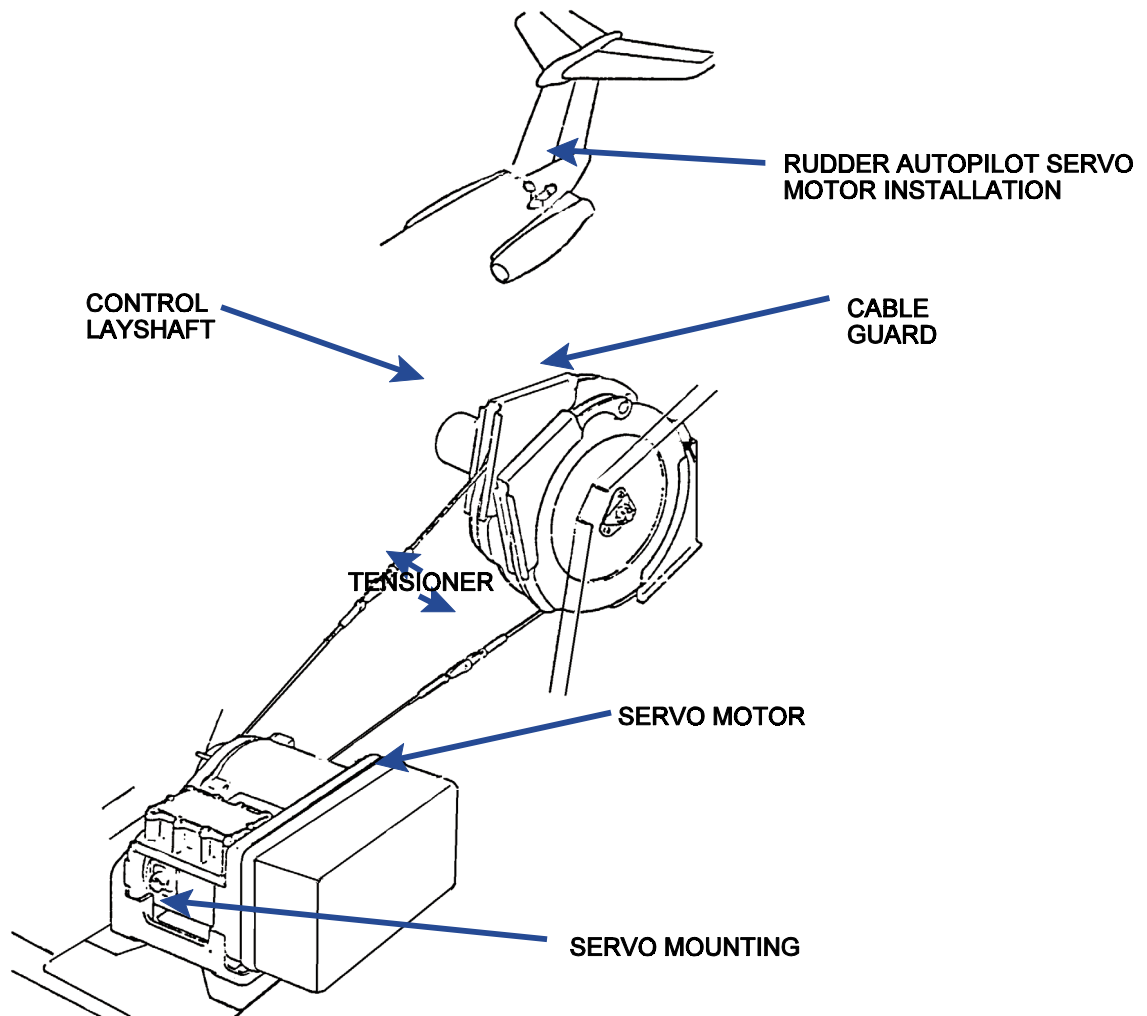

Figure 30.8 Rudder Controls

Yaw Rate Signal

The yaw rate signal is derived from a synchro attached to the yaw rate gyro which forms part of the Three-Axis rate transmitter. The Band Pass Filter has a peak frequency of 0.2Hz, which is the natural yawing frequency of the aircraft. It attenuates steady and slowly changing yaw rate signals which are present during a steady turn to prevent unwanted rudder deflection which would mis-coordinate the manoeuvre.

Bank Demand Crossfeed

To improve co-ordination in autopilot control, the rudder correction is applied during the manoeuvres. the demand signal is modified by a function of IAS from the CADC. This is because a smaller rudder deflection is needed at high speed than at low speed for a given bank angle.

Dynamic Vertical Sensor

Dynamic Vertical Sensor, which consists of a damped pendulum, provides a signal which is proportional to the difference between the aircraft vertical and the dynamic vertical. In the long term, yawing movement caused by an un-coordinated turn or engine failure is thus opposed by a sustained rudder deflection instead of a side slip.

When the flap selector lever is moved to give more than 26° of flap, the flap relays the increase the gain of the dynamic vertical sensor signal, and decrease the gain of the yaw rate signal.

Series Yaw Damper Operation

The yaw damper provides damping of the aircraft's yaw axis movement by shaping, amplifying and coupling rate gyro and yaw damper actuator position signals to control the rudder through the hydraulic actuator. The yaw damper operation is confined to **synchronisation mode and engaged mode**.

Operating Modes

Synchronisation

Is to prevent yaw axis engagement transients by cancelling servo motor outputs by an inverting integrator. RL1 is energised prior to yaw damper engagement. Any amplifier output is fed back through the integrator, the inversion through the integrator cancels any transients present. On engagement of the yaw damper, RL1 is de-energised.

Engaged Mode

Providing the interlock logic is good, the engage solenoid engages allowing the yaw damper elements of the Power Control Unit (PCU) to pressurise. The rate gyro signal is phase advanced and applied to the de-modulator. The demodulator converts the signal to a DC signal where the output polarity will represent the AC signal input phase. The yaw damper frequency is passed by the bandpass filter which blocks all other frequencies. Consequently, the yaw damper does not oppose normal turn manoeuvres and does not respond to aircraft vibration and bending. The modulator restores the AC signal maintaining the appropriate phase. The servo amplifies the signal and applies it to the transfer valve which in turn drives the yaw damper actuator which drives the main actuator. The maximum deflection of the rudder is 3° - 4° in either direction.

The LVDT position feedback is applied to SP2 to cancel the processed rate gyro signal when the corresponding change in rudder position is appropriate for the rate of yaw change. Position feedback is also applied through the energised relays of RL2 which is fed back to SP2. The purpose of this is to ensure that the rudder will always return back to the neutral position. The rudder can be effected by crosswinds. If the crosswind is strong, the position feedback voltage may not be large enough to drive the rudder to the central position. The position feedback voltage now causes INT 2 to ramp up, increasing the voltage at SP2. This increase in position feedback starts to drive the rudder back to the neutral position. As the rudder returns the position feedback voltage decreases allowing the integrator to run down.

Yaw Damper Testing

Actuation of the yaw damper test switch to either the right or the left applies a voltage to the yaw damper rate gyro torquing coil which torques the rate gyro and simulates aircraft movement. The rudder position indicator responds to this action of an output from the position transducer. If the switch is moved to the left the indication will first move to the left and then back to the centre, on release of the switch the indication will move to the right and back to the centre. The reverse will happen if the switch is first moved to the right.

Yaw Damper Indications

Yaw damper controls and indications are fairly simple. On a typical aircraft (fitted with 2 yaw dampers), the main indications will be a panel or part thereof that contains an on/off switch, a test switch or button and a failure light for each of the yaw dampers. The failure light indicates many faults in the system; loss of hydraulic or electrical power, logic failure in the yaw damper computation system, loss of input from the rate gyro. The switch can then be used to isolate the inoperative yaw damper to avoid spurious rudder inputs.

Also involved with the monitoring of the yaw dampers is a small rudder trim indicator, one for each yaw damper system fitted. It indicates the demands on the rudder by moving left and right of centre. It is mainly used during the testing of the yaw dampers during pre-flight checks. If the yaw damper test switch is operated for one of the yaw dampers a test signal operates a small torquing coil on the yaw damper rate gyro. This moves the gyro and fools the yaw damper system into thinking that an yaw condition exists. A pass at test is indicated by the position moving in the direction tested and back to centre. Moving the switch to the left simulates a yaw in one direction and the position indicator should move to left also. If the switch is operated to the right then the rudder should move to the right.

Other aircraft use a test system where an artificial signal representing an oscillatory yaw is used causing the rudder to move left and right at approximately 0.5 Hz. The yaw damper is switched on and the oscillations should stop.

Common to all these tests is the fact that if the yaw damper is engaged the rudder itself may be being moved and as with moving any surface or service on the ground there are safety considerations.

RUDDER CONTROL SYSTEM SCHEMATIC (Boeing 727)

Manual inputs from the rudder pedals to the rudder power unit is by cables through the rudder feel and centring unit. The feel is accomplished by a feel and centring spring. The input crank positions the control valve through the summing assembly. The hydraulic pressure is ported to move the main actuator. The main actuator to the external summing lever returns the control valve to neutral, stopping further movement. A right rudder command is demonstrated by the solid arrows and the dashed line indicates feedback.

When the yaw damper is engaged, the yaw damper actuator solenoid will energise allowing hydraulic pressure into the transfer valve. When a signal is received from the yaw damper the transfer valve converts the signal from an electrical signal into a hydraulic signal. The output of the transfer valve displaces the yaw damper actuator which is pivoted about "A" displacing the control valve. The hydraulic output moves the main actuator, the feedback will move the external summing lever as the rudder is moved. This will stop the rudder movement. The rudder is recentered by a feedback signal from the LVDT to the yaw damper coupler. Command is limited to $\pm 5^\circ$.

The Boeing 727 yaw damper is a series system. Therefore, yaw damper inputs will not be fed back to the rudder pedals. This is achieved through the external summing lever. This unit allows the main rudder power control unit to move the rudder but the swinging function about the input shaft pivot does not transfer the movement back to the rudder pedals.

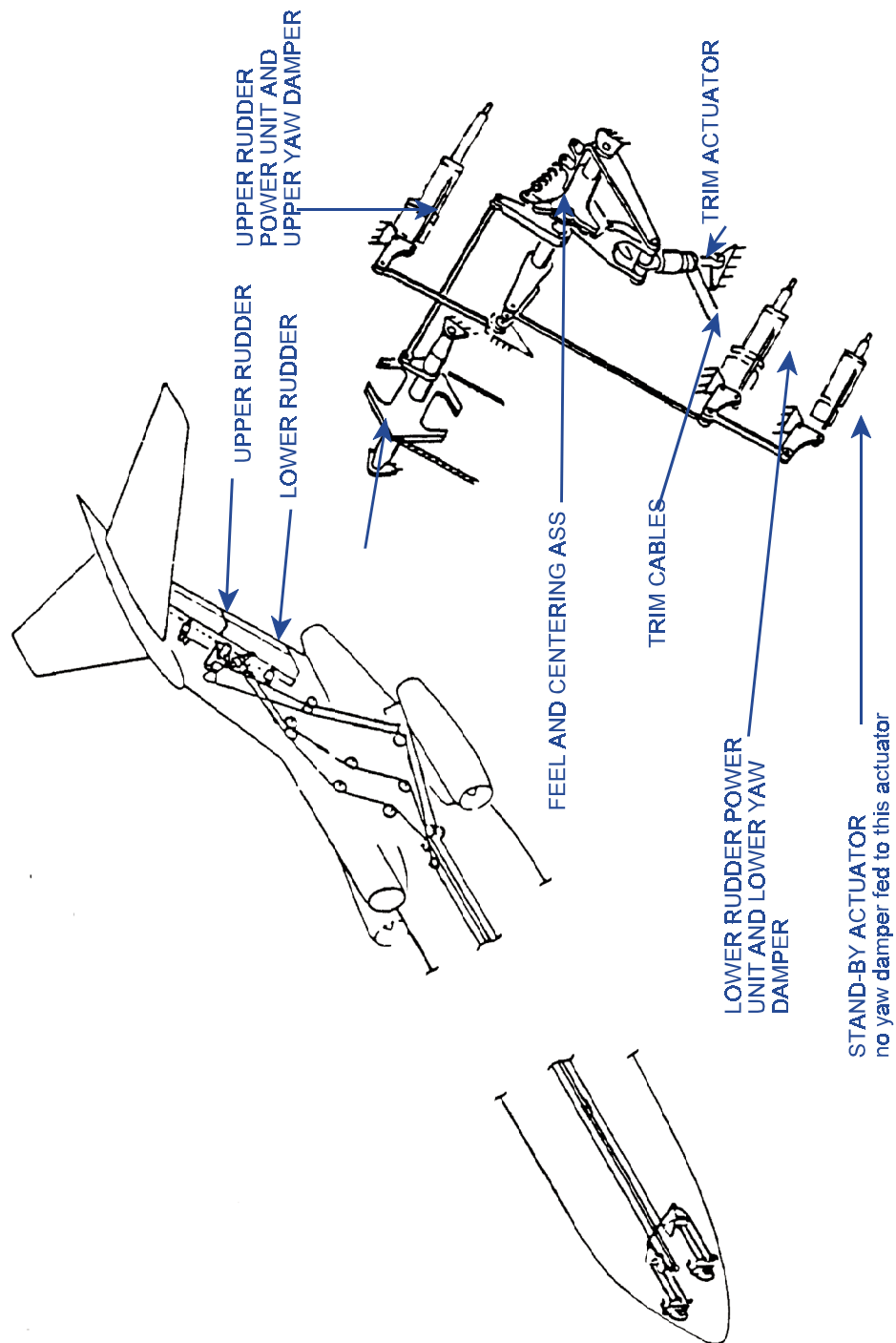

Figure 30.9 Rudder Control System Schematic (Boeing 727)

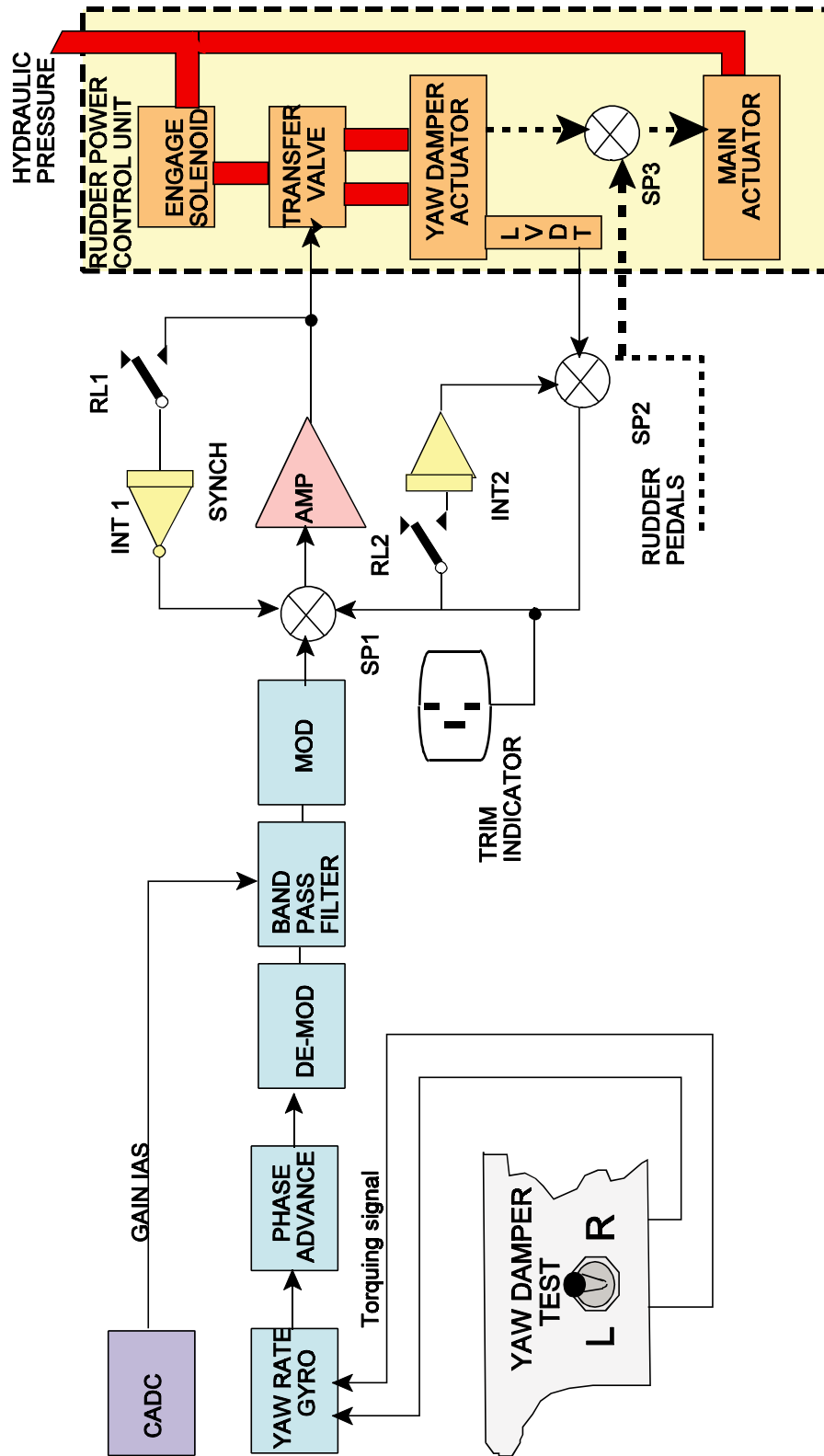

Figure 30.10 Series Yaw Damper Systematic Diagram

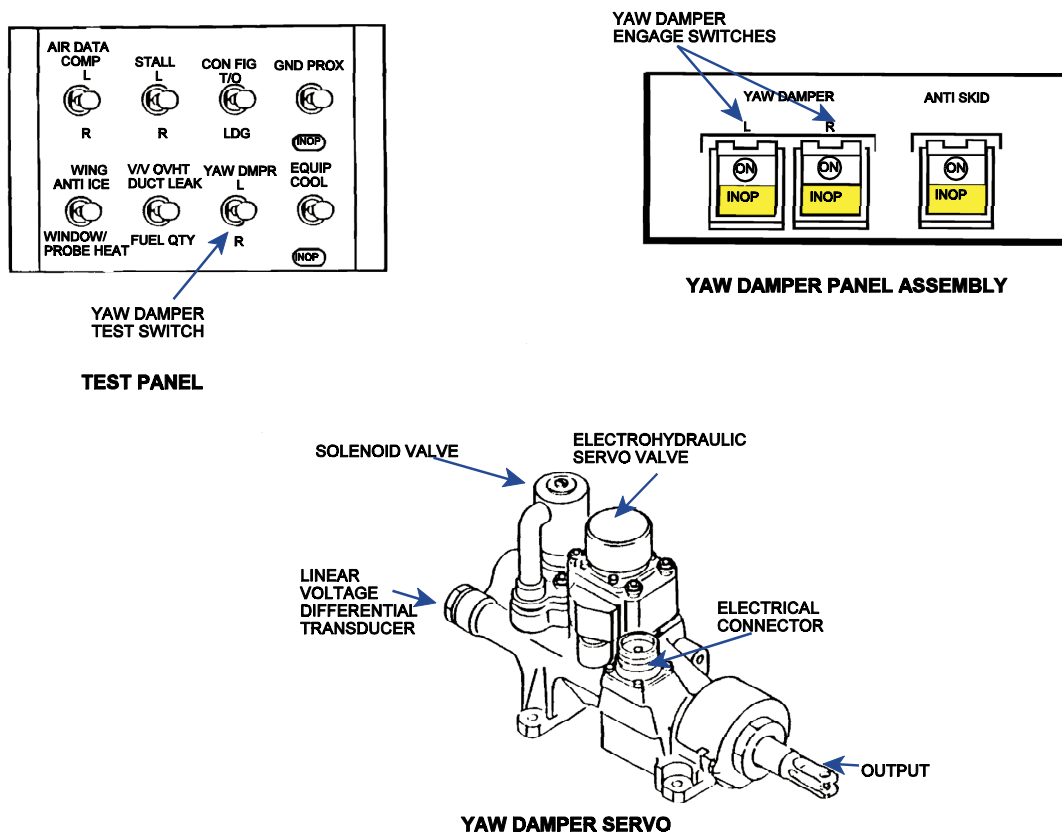

Figure 30.11 Boeing 757 Yaw Damper Panels and Yaw Damper Servo

EXAMPLE OF SEPARATE YAW DAMPER AND MAIN ACTUATOR (BOEING 757/767)

The input from the servo amplifier to the actuator is converted from an electrical signal to a hydraulic demand by a conventional **transfer valve**. The yaw damper usually has its own actuator with a LVDT for position feedback. A main actuator controls the rudder. The two individual actuator systems allows easy separation between manual inputs and autopilot inputs in a **series** connected yaw damper.

Figure 30.13 shows practical connection of the two actuator systems. The diagram is based on a Boeing 757. Two yaw dampers are fitted, the left and right system. Each yaw damper can be selected individually from the yaw damper control panel, both systems are operating together.

Each system feeds its own servo actuator, supplied by a different hydraulic system. A mechanical linkage connects both outputs into the main rudder actuators. With all three hydraulic systems and all three actuators serviceable, the three actuators will operate simultaneously to control the rudder.

Series interfacing with rudder

The inputs to the rudder system are in series with the pilots rudder input. This means that although the rudder is being moved by the yaw dampers and some of the rudder authority that pilot would normally have is being lost, the pilot will not feel the operation of the yaw damper through the pedals.

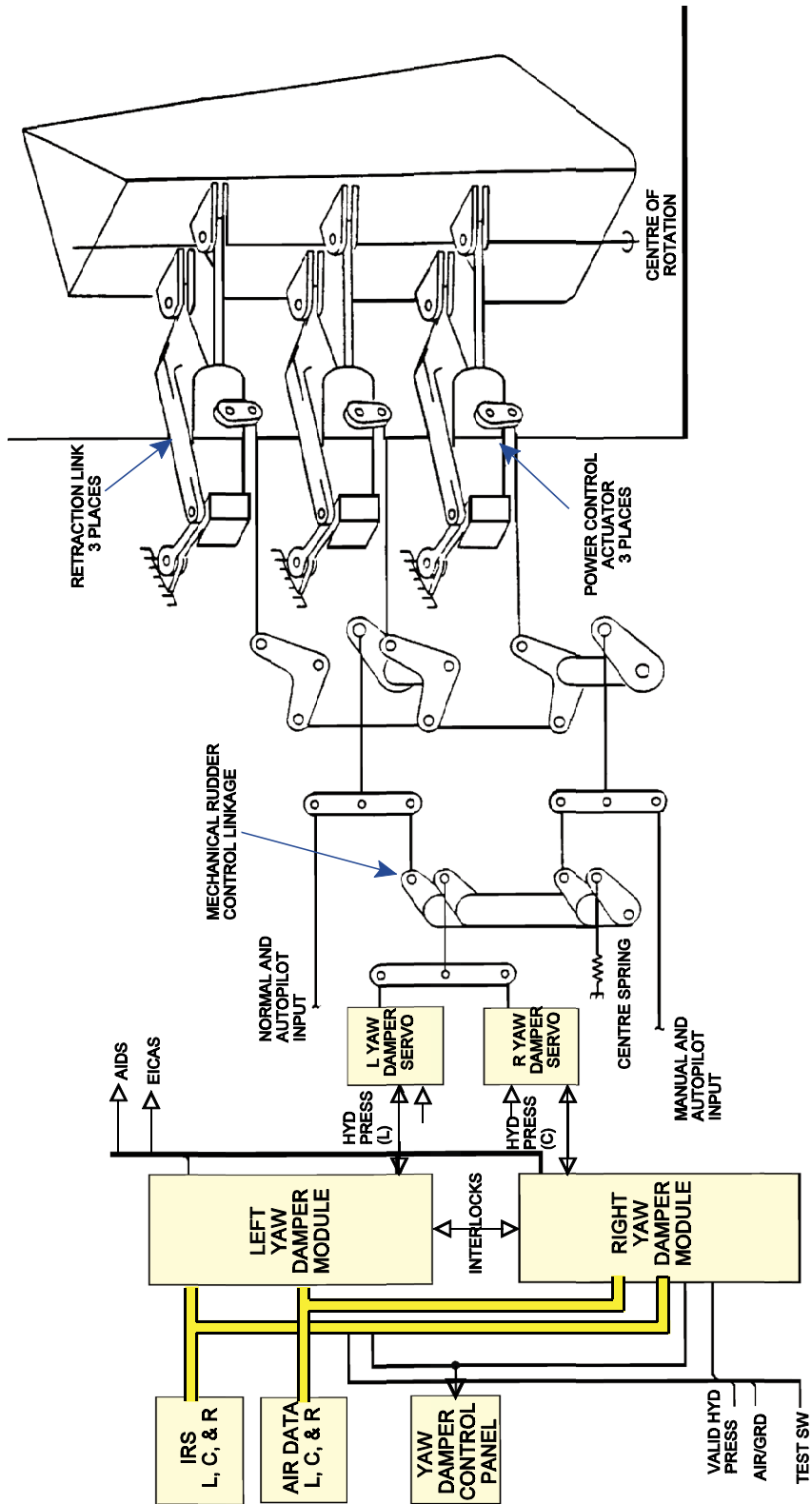

Figure 30.12 Simplified Schematic of Boeing 757 Yaw Damper Actuators

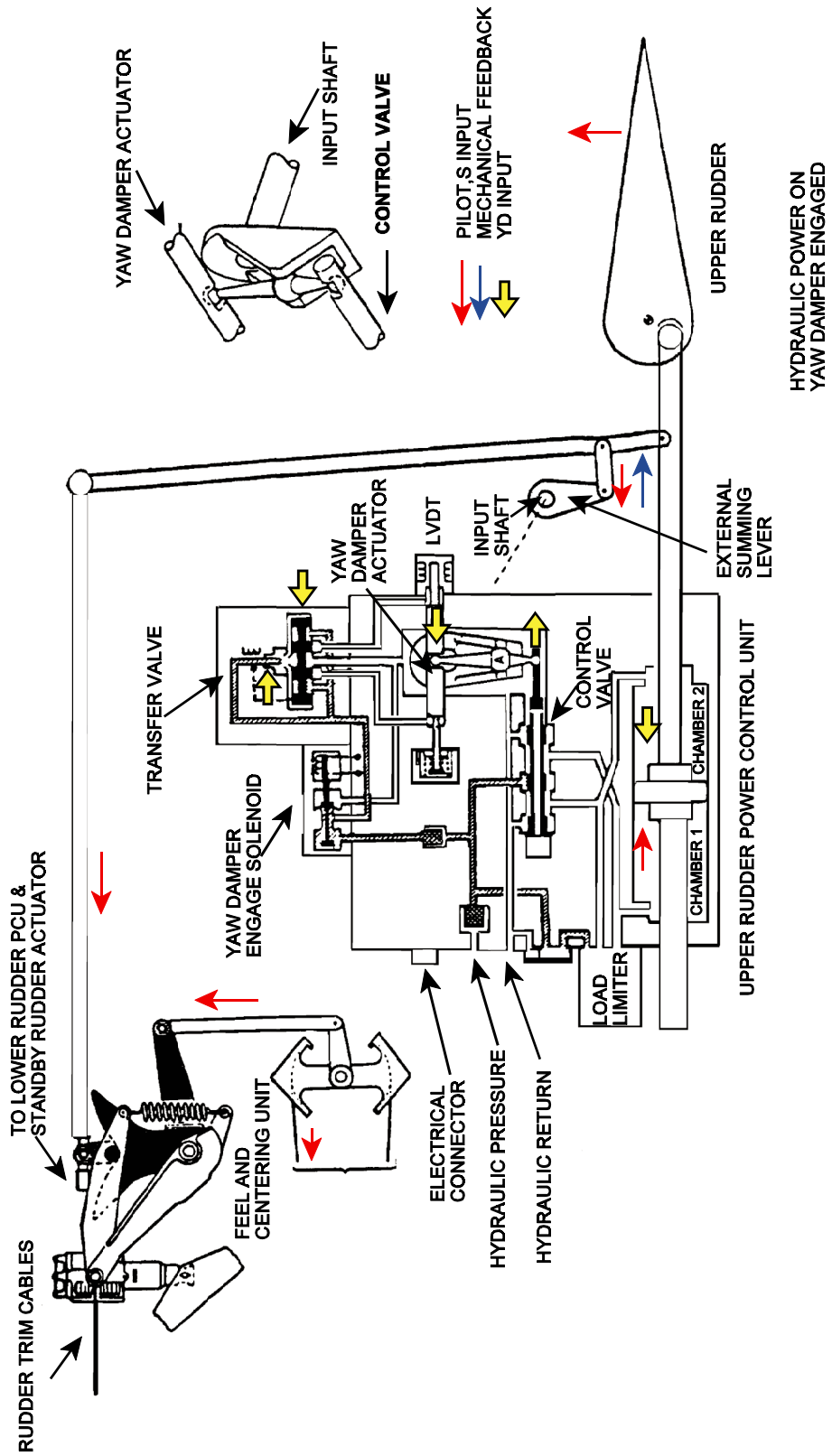

Figure 30.13 Rudder Control System Schematic

Power Sources for movement (s/m/l)

Small aircraft without a substantial hydraulic system that still require yaw damping may use electrical actuation to achieve rudder movement. Large aircraft will invariably use hydraulic actuation through the normal rudder power system. Some more obscure types may use pneumatic actuation.

Monitoring

As has been stated previously a yaw damper runaway can be guarded against by reducing the amount of control input it can achieve in the event of a fault occurring. With 2 yaw damper systems running side by side however, they can be used to monitor each other. This is called Duplexing.

This comparison can be carried out electrically or mechanically. The example shown is of the latter type from a BAe 146 RJ.

**EXAMPLE OF A DUPLEX YAW DAMPER SYSTEM
(SMITH'S - Bae 146)**

Some yaw damper systems operate in a **duplex** mode (**duplex monitoring**), providing lateral stabilisation through all phases of flight.

A duplex system provides the monitoring necessary to prevent large fast movements of the rudder in the event of a runaway fault condition. The two channels are identical and independent, their outputs being fed to a comparator. Misalignment between them will cause automatic disengagement of both channels. Figure 30.14 shows a block diagram of the system.

As the channels are identical, only one single channel will be considered:

Any unwanted lateral movement generates a yaw rate gyro 400 Hz signal. The phase of the signal will determine the direction of the rudder and the amplitude will determine the rate of movement of the rudder. The signal is reduced at 30° of flap to compensate for the effects of increased airflow over the control surface.

The vertical gyro input is differentiated to produce a roll rate signal to assist in rudder application when a roll is sensed. If the roll is a commanded turn, the roll rate signal decays quickly to prevent the rudder opposing the turn.

The roll rate and yaw rate signals are fed through a 90° phase advance differentiating capacitor to accelerate the signal to ensure that damping is applied at the correct time. The signal is then summed with the Lateral Accelerometer. The accelerometer applies rudder to compensate for slip and skid during a turn.

The summed yaw rate, roll and lateral signal is fed to the input of a servo amplifier where it is summed with the rate and position feedback. The resultant of this summation is used to control the actuator motor drive circuit and hence the actuator motor. This is mechanically linked to a tacho-generator to provide rate feedback and an LVDT to provide position feedback.

Each actuator motor drives two rams which drive one side of a 'T' bar onto the rudder drive mechanism. The right angles at the top of this 'T' bar are checked by the comparator switches, misalignment causes **both** yaw dampers to be disengaged.

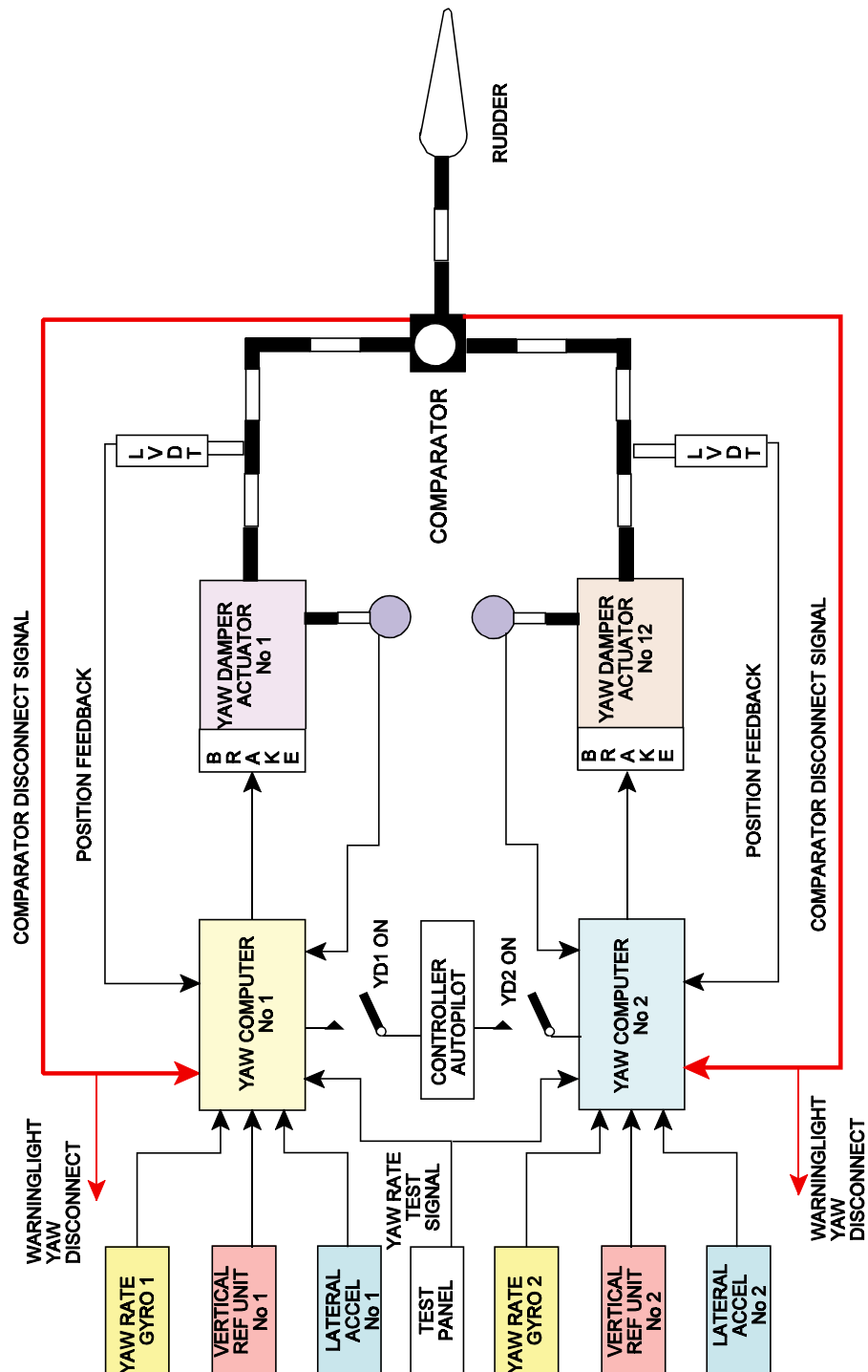

Figure 30.14 Duplex Monitor Yaw Damper System - Smiths BAe 146

Different sources of 115V 400Hz and 28VDC are provided to both channels. The initial switch on is made by two master yaw damper switches. This provides initial power to the system and allows the gyros to run up. The actuator brake will still be on at this time and the power held off the servo amp. Engaging the yaw dampers on the autopilot controller starts interlock and monitor circuit operation. A one second timer starts, which allows the actuators to align. The actuator brakes are released and engagement is complete.

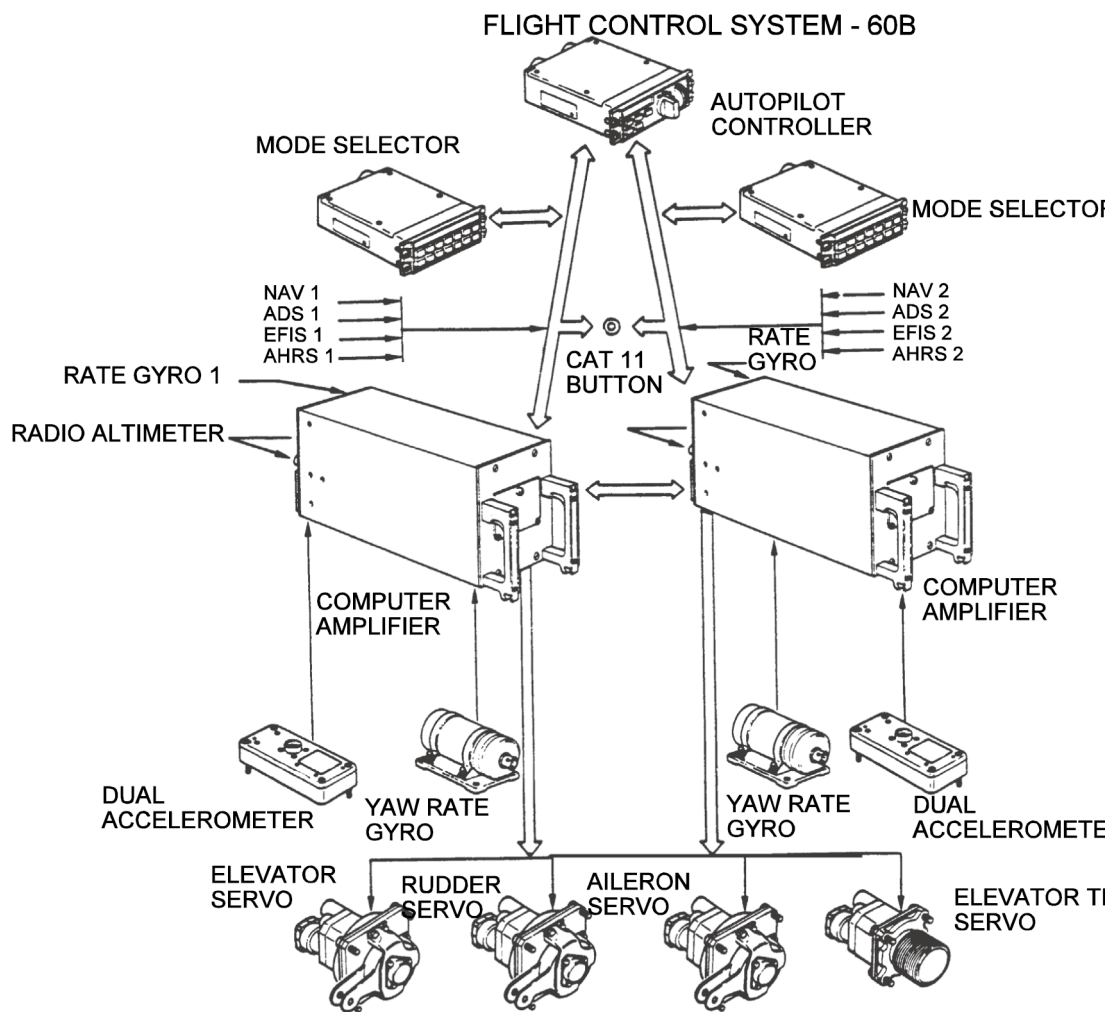

Figure 30.15 Bendix FCS-60B Three Axis Autopilot - Dual Control

Vibration

All structures have frequencies at which they oscillate or resonate. The vibrations can be caused by the engines, pumps, generators, aerodynamic loads etc. These vibrations cause flexing of the structure which leads to fatigue and eventually failure of the structure. The vibrations can also cause passenger discomfort in the form of fatigue due to excess noise and motion sickness. The very latest yaw damper systems (767 era) have between 2 and 4 Modal Accelerometers fitted fore and aft. These are fed in parallel with the gyro input and allow the yaw damper system to utilize the rudder to damp out these vibrations. This increases both passenger comfort and decreases fatigue of the airframe thus increasing its life.

CHAPTER THIRTY ONE

CONTROL LAWS

Contents

INTRODUCTION 439

BOEING 737-400 AUTO PILOT LIMITING AND REVERSION MODES 439

FLIGHT ENVELOPE PROTECTION. 441

THE PROTECTION 441

HIGH ANGLE OF ATTACK 441

HIGH SPEED 442

PITCH ATTITUDE 442

BANK ANGLE 442

LOAD FACTOR 442

AUTOPILOT GAIN ADAPTION / GAIN SCHEDULING. 443

INTRODUCTION

The autopilot must be able to manoeuvre the aircraft logically and safely in a similar manner to the way a human pilot should. This means ensuring the autopilot does not break aircraft limitations in terms of speed, load factor, pitch and bank limits etc. However the autopilot should be able to use a satisfactory amount of the performance of the aircraft otherwise the manoeuvres would take too long to execute.

For example consider a light aircraft on a VFR navigational exercise. Overhead the next way-point the pilot requires an 80° left turn to proceed to the next point. The bank angle used will be determined by that turn. The pilot will not generally choose under normal circumstances to turn with 5° of bank as that would mean the turn taking an inordinate amount of time. Conversely the pilot would not normally choose a 90° banked turn as that would be excessively hard, possibly breaking load factor limitations as well as probably causing a loss of height. A turn using 30° - 45° angle of bank would be the most sensible. If the turn required was about 10° instead of 80° then banking to 30° would generally be considered to be too harsh.

The autopilot needs to be able to apply similar logic to all its actions. Whenever the autopilot is required to make a correction either for stability or when referring to a particular flight path the control response will always be in proportion to deviation or corrective action required but only up to a limit that prevents the autopilot attempting a manoeuvre that would cause an excursion from the safe flight envelope.

BOEING 737-400 AUTO PILOT LIMITING AND REVERSION MODES

Command Speed Limiting and Reversion Modes

To prevent the AFS from causing a flight envelope excursion there is a system of command speed limiting and reversion modes. AFS command limiting and reversion is independent of the stall warning and airspeed/Mach warning systems.

Command Speed Limiting

The AFS provides speed, pitch and thrust commands to avoid exceeding the following limit speeds:

- VMO / M MO.
- Wing flap limiting speeds.
- Landing gear speeds.
- Minimum speeds

The commanded speed can be equal to, but will not exceed a limit speed.

Speeds greater than VMO / M MO cannot be selected from the MCP. Speeds can be selected which exceed flap and gear limiting speeds or that are less than the minimum flight speed.

Minimum speed is based on an angle of attack and is approximately 1.3V_S for the current flap configuration. It is sensed by the angle of attack vanes, one on either side of the forward fuselage.

If a speed greater than a placard speed, or less than the minimum speed is selected, the AFS allows acceleration or deceleration to slightly short of the limit, then commands the limit speed. The over-speed or under-speed limiting symbol appears in the MCP IAS/Mach display when the commanded speed cannot be reached.

Either pitch or thrust, whichever is engaged in a speed mode, attempts to hold the limit speed. The commanded limit speed and MCP speed condition symbol remain until another speed is selected which does not exceed the limit. A speed 15 kts greater than the minimum speed must be selected to remove the under-speed symbol.

Reversion Modes

During some flight situations, speed control by the AFDS or A/T alone could be insufficient to prevent exceeding a limit speed. If this occurs, AFDS and A/T mode automatically revert to a more effective combination. The reversion modes are:

Placard Limit reversion.

Minimum airspeed reversion.

Mode reversion occurs slightly before reaching the limit speed. Both the AFDS and the A/T have reversion modes which activate according to the condition causing the reversion.

Placard Limit Reversion

When one of the placard limits (gear, flap or VMO / M MO) is reached, the over-speed limiting symbol appears in the MCP IAS/Mach display and the following occurs:

- If not in AFDS or A/T speed control and the A/T is armed, the A/T reverts to SPEED mode and controls speed to the placard limit.
- If in AFDS or A/T speed control, no reversion is necessary. The AFDS or A/T, whichever is controlling speed, holds speed slightly below the placard limit.
- If the A/T is not available, no reversion response to gear or flap placard speeds is available. The AFDS reverts to speed control for VMO / M MO speed limiting.

Minimum Speed Reversion

The AFDS and A/T do not control speed to a speed which is less than the minimum speed for the current flap configuration. This speed is approximately 1.3 VS. Minimum speed, FMC speed or selected speed, whichever is higher, becomes the AFS commanded speed. If actual speed becomes equal to or slightly less than the minimum speed, the under speed limiting symbol appears in the MCP IAS/Mach display and if operating in the V/S mode, the AFDS reverts to LVL CHG.

The AFS commands a speed 5 kts greater than the minimum speed. Selecting a speed 15 kts greater than the minimum speed reactivates normal MCP speed selection control. The AFDS commands nose down pitch to increase airspeed if the thrust levers are not advanced. When actual speed becomes 15 kts greater than minimum speed, the under speed limiting symbol disappears.

The A/P disengages and the FD command bars retract when in LVL CHG climb with a command speed equal to minimum speed and a minimum rate of climb cannot be maintained without decelerating.

No minimum speed reversion is available when the A/T is OFF and the AFDS is in ALT HOLD, ALT ACQ or after G/S capture.

FLIGHT ENVELOPE PROTECTION

INTRODUCTION

Flight envelope protection is taken to the extreme by fly-by-wire aircraft with the aim of ensuring that the aircraft remains **within** the normal flight envelope in all phases of flight. The system prevents the envelope being violated during **extreme situations**, such as:

- Windshear
- Very high turbulence
- Midair collision avoidance
- GPWS or TCAS activation
- Mismanagement by the crew.

The purpose of the flight envelope protection is to:

- Give **full authority** to the pilot in order to consistently achieve the **best possible aircraft performance** in those extreme conditions.
- **Reduce the risks** of over controlling / overstressing the aircraft.
- Provide the pilot with an easy, instinctive and immediate procedure to achieve the best possible performance when required.

THE PROTECTION

The system provides protection in all phases of flight to prevent the aircraft exceeding the limits for the following parameters:

- Angle of attack
- Speed
- Pitch attitude
- Bank angle
- Load factor.

HIGH ANGLE OF ATTACK

The protection enables the pilot to execute a rapid pull-up manoeuvre in an emergency situation (as in a midair collision avoidance situation) at **maximum angle of attack**, max, without overcontrolling the aircraft. The technique requires simply that the pilot “snatch stick fully back”. If the aircraft exceeds the normal flight envelope for any reason, the pilot is immediately made aware of the situation by the pitch auto-trim stop and the aft pressure required on the stick to keep the flight path. The high angle of attack protection is an aerodynamic protection but thrust is required to maintain the flight path and the auto-thrust function would automatically provide TOGA thrust when the aircraft reaches a certain value (called floor) before it gets to max. The input to the circuit is the angle of attack and the output is applied to the elevators and the auto-thrust.

HIGH SPEED

High speed protection circuits prevent the aircraft from reaching V_d / M_d by adding a positive nose-up G demand to the pilot demand on the stick; this **demand is proportional to the amount of speed overshoot beyond V_{mo} / M_{mo}** . This enables a pilot to enter a steep dive rapidly by pushing the stick forward, safe in the knowledge that the high speed protection will prevent the aircraft from exceeding the design speed limits.

The inputs to the unit would be airspeed/mach no. from the air data computer and the output is applied to the elevators.

PITCH ATTITUDE

The pitch attitude protection enhances the high angle of attack protection and the high speed protection. The circuit reduces the pitch demand of the stick when the aircraft reaches the pre-defined maximum pitch attitude values which are:

30° nose-up and 15° nose-down.

The input is the pitch angle from the attitude gyros and the output is applied to the elevators.

BANK ANGLE

On a commercial aircraft the bank angle does not normally exceed 30°. However in certain circumstances higher bank angles might be required. Bank angle protection allows the pilot to achieve any roll manoeuvre efficiently and prevents the aircraft entering into an uncontrollable state. For example, the limits of bank angle for an Airbus aircraft are:

- 67° in the normal flight envelope
- 45° when high A.o.A is triggered
- 40° when high speed protection is triggered.

After a roll manoeuvre if the pilot releases the stick the aircraft would return to a bank angle of 33. The bank angle limit is achieved by **reducing the roll rate demand progressively** as the bank angle increases.

LOAD FACTOR

A commercial aircraft is designed to withstand a maximum load factor, beyond which structural damage is likely to occur. In aircraft where no protection is provided the pilot has to assess the instantaneous G load and could overstress the aircraft in an urgent situation.

Load factor protection is provided by sensing the G load on the aircraft with accelerometers. The G load limiter protects the aircraft against overstress by maintaining it within its structural limitations while allowing the pilot to react immediately to an evasive manoeuvre. The load factor protection is linked to the high angle of attack protection.

AUTOPILOT GAIN ADAPTION / GAIN SCHEDULING

In the same way as the Flight Director System uses gain scheduling to reduce demands when in close proximity with the ground in order to ensure that the FD system does not demand a manoeuvre that would endanger the aircraft, the autopilot has a comparable system. This ensures that for example, during an auto-land the autopilots pitch and roll authority is significantly reduced as the aircraft nears the ground. An example of this may be an aircraft that has an autopilot which when used in the manual mode may have bank angle limited to 45°. During VOR or Localiser tracking this may be reduced to 30° as that is deemed all that is necessary. However during the final phase of an automatic approach or an auto-land this may be reduced to 15°.

Gain adaption may also be used to alter the autopilots limits to allow for differing aircraft performance at different altitudes and speeds. Although artificial feel is provided to give pilots awareness of control forces, autopilots could easily ignore artificial feel inputs and overstress the aircraft. So an input from the ADC to the autopilot may be used to reduce the autopilots authority in proportion to Q .

CHAPTER THIRTY TWO
REVISION QUESTIONS - AFCS

Contents

QUESTION PAPER 1447
QUESTION PAPER 2453
ANSWERS - PAPER 1456
ANSWERS - PAPER 2457

QUESTION PAPER 1

1. A single axis autopilot system:
 - a. Provides stabilisation about the normal axis
 - b. Provides control about the pitch axis
 - c. Is unsuitable for use in powered aircraft
 - d. Provides control about the roll axis

 2. A single axis autopilot may also be called:
 - a. Altitude hold
 - b. Wing leveller
 - c. Pitch control loop
 - d. Auto stabilisation loop

 3. An auto pilot:
 - a. Is a system which will maintain a preselected altitude
 - b. is a system which will maintain a preselected airspeed
 - c. is an auto stabilisation system
 - d. Is an outer loop control system

 4. The fundamental components of an autopilot control loop are:
 - a. Rate gyro, servomotor, error signal generator
 - b. Rate gyro, servo motor, torque limiter
 - c. Torque limiter, error signal generator, servomotor
 - d. Servo motor, rate gyro, torque limiter, error signal generator

 5. A device in a closed loop control system in which a small power input controls a much larger power output in a strictly proportionate manner is:
 - a. An amplifier
 - b. A servomechanism
 - c. A powered flying control unit
 - d. A rate gyro

 6. An automatic flight control system:
 - a. Is another name for an autopilot system
 - b. Applies flight data to the auto pilot system
 - c. Is automatically disengaged by a GPWS alert
 - d. Can only be used in EFIS equipped aircraft

 7. An aircraft has yaw damping included in its auto stabilisation system. An essential requirement of such a system is:
 - a. A three axis autopilot system
 - b. Parallel connected servo motors
 - c. Automatic maintenance of c of g position
 - d. INS inputs to the CADC
-

8. Automatic flight systems may be capable of controlling the aircraft flight in:
- Azimuth, elevation and velocity
 - Azimuth and velocity only
 - Azimuth only
 - Azimuth and elevation only
9. An automatic flight control system is fitted with control wheel steering (CWS)
- The autopilot must be disengaged before the pilot can input manoeuvring commands
 - Manoeuvring commands may be input by applying normal forces to the control yoke without first disengaging the autopilot
 - Manoeuvring commands may be input using pitch and turn controls on the automatic flight system control panel, without first disengaging the autopilot
 - The CWS is only there for steering on the ground
10. During an approach to an autoland at 1500 feet:
- Off line channels are manually engaged, flare mode is armed
 - Localiser is controlling the roll channel, off line channels are automatically engaged and flare mode is armed
 - Localiser is controlling the roll channel, stabiliser is trimmed nose up and roll out is armed
 - Provided both localiser and glideslope signals are valid LAND 3 will illuminate
11. What type of autoland system would be required for the landing to continue following a single failure below alert height:
- Fail soft
 - Fail passive
 - Fail operational or fail active
 - Land 2 system
12. Inputs to the rudder channels initially originate from:
- Servomotors
 - Compass gyro and gyro for AH
 - Compass gyro and turn and slip gyro
 - AH gyro and turn and slip gyro
13. An automatic flight system which can safely continue with an automatic landing after a system failure is a:
- Fail redundant system
 - Fail passive system
 - Three axis system
 - Fail operational system
14. Altitude Select and Altitude Hold are examples of:
- inner loop functions in pitch
 - manometric functions from the ADC
 - interlocking functions
 - outer loop functions in roll

15. During an autoland the caption LAND 2 is illuminated. The system is:
- Fail active or fail operational
 - Fail passive
 - Approaching decision height
 - Requiring a crew input
16. For an autoland system to meet FAIL PASSIVE criteria it must:
- Have suitable system redundancy
 - Withstand a system failure without excessive deviations from flight path
 - Can continue with an autoland below alert height
 - Can continue with an autoland above alert height
17. During an autoland at 50 ft AGL (45' GA) the pitch control of the autopilot is and the roll control is
- glideslope localiser
 - glideslope roll out
 - flare roll out
 - flare localiser
18. During an autoland approach:
- Flare is engaged at 1500'agl
 - localiser roll control is disengaged just prior to touchdown
 - flare is disengaged prior to touchdown at 5'GA
 - glideslope is the engaged pitch mode until 5'GA
19. In an autoland at 1000' AGL with two autopilots engaged:
- The armed roll mode would be LOCALISER
 - The engaged roll mode would be GLIDESLOPE
 - The engaged pitch mode would be FLARE
 - The engaged roll mode would be LOCALISER.
20. An automatic flight control system in which the application of normal forces on the control column allows the pilot to input demands to the autopilot is a:
- control wheel steering
 - touch control steering
 - series connected system
 - parallel connected system.
21. If a fault develops in a Triplex auto-pilot system during an approach, the system will revert to:
- fail passive and the landing may continue.
 - fail control wheel mode.
 - fail operational.
 - a manual disconnect.

22. Central Air Data Computers (CADC's) transmit data concerning;-
- airspeed, altitude and decision height.
 - airspeed, altitude and Mach Number.
 - airspeed, attitude and Mach Number.
 - airspeed and altitude only.
23. Inner loop stability is obtained by;-
- inputs from the Air Data Computer.
 - manometric locks.
 - 'T' bar displacement.
 - raw data feed to the data control bus bar.
24. The auto-throttle is used to control some factors during the three primary control modes, they are:
- EPR, Mach and Speed.
 - EPR, wheel and speed
 - EPR, Mach and altitude.
 - EPR, wheel and altitude.
25. The mode that enables the pilot to manoeuvre his aircraft in pitch and roll by use of the automatic control system is called the;-
- control wheel steering (CWS) mode that allows the pilot to control the aircraft, and when the wheel is released, the aircraft holds the newly established attitude.
 - touch control steering that will permit the pilot to control the aircraft via the air data computer.
 - control wheel steering mode which will disengage the servomotors.
 - the touch control steering mode which will prevent the flaps retracting.
26. Touch control steering:
- prevents aerodynamic feedback.
 - will only operate while the flaps are down.
 - allows the pilot to control the aircraft with the servomotors disengaged.
 - engages the servomotors during manual operation in pitch and roll.
27. A system which can still function without degradation of performance after a failure has:
- fail passive ability.
 - fail soft ability.
 - fail operational ability.
 - fail symbol ability.
28. During a CAT 2 ILS automatic approach, the source for altitude information is the:
- basic altitude capsule stack.
 - radar altimeter which becomes effective below about 2,500 feet.
 - radio altimeter which becomes effective below about 2,500 feet.
 - mode comparator sensor.

29. Heading hold mode relates to control in:
- the height lock via the CADC.
 - the pitch channel via the inner loop.
 - the roll channel via the outer loop control source.
 - the manometer mode of the CADC.
30. The system which allows the pilot to control the aircraft with the servomotors engaged is called:
- touch control steering.
 - control wheel steering.
 - the electronic inner / outer axis loop.
 - the outer loop control.
31. The type of automatic landing system which would necessitate a manual landing after a system failure during an automatic approach is:
- fail passive.
 - fail safe.
 - fail active.
 - fail operational.
32. After a failure of one of the necessary redundant systems below alert height you would:
- continue the descent but revert to a higher D.H.
 - carry out a missed approach.
 - disengage autoland and take over manually.
 - continue descent and land automatically.
33. When localiser and glide slope are captured at 1,500 feet during an automatic landing sequence, two other functions will be activated at the same time, they are:-
- touch down mode and roll out mode.
 - flare mode arm and touch down mode.
 - flare mode engage and roll out mode.
 - flare mode arm and off line channels engaged.
34. A fundamental requirement of a closed loop servo-mechanism is:-
- a stable reference device.
 - an interlock control.
 - a tacho-generator.
 - feedback.
35. ALT HOLD is an example of:
- Inner loop control in the roll axis
 - Outer loop input to the pitch channel
 - Outer loop control about the longitudinal axis
 - Inner loop control in the pitch axis

36. A rate gyro:
- Has three degrees of freedom, two gimbals and a transducer
 - Senses rate of turn and positions an indicator on the EHSI
 - Supplies rate and displacement information to the computer
 - Controls the outer loop inputs
37. To prevent servo motor runaway from producing excessive demands to the control surface:
- A gyro damper is fitted
 - A torque limiter is fitted
 - A gyro limiter is fitted
 - A torque converter is fitted
38. Autotrim is functional:
- In the pitch and roll channel with the autopilot engaged
 - In the pitch channel only with the autopilot engaged
 - In the pitch channel only with the autopilot disengaged
 - In the pitch and roll channel with the autopilot disengaged
39. L.NAV is an..... input to thechannel using data from the.....
- outer loop, pitch, FMC
 - inner loop, pitch, ADC
 - outer loop, roll, FMC
 - inner loop, roll, ADC
40. In an aircraft which requires a mach trim system it will apply inputs to the horizontal stabilizer:
- All the time
 - At high mach numbers with the autopilot engaged
 - At mach one with the autopilot engaged or not
 - At high subsonic speeds with the autopilot engaged or not.

QUESTION PAPER 2

1. With the Autopilot engaged in the Alt mode the Captain alters the barometric setting. The aircraft:
 - a. maintains its altitude
 - b. changes its altitude in accordance with the change in pressure setting
 - c. switches barometric input over to the 1st Pilot setting
 - d. trips out of altitude hold.
2. Control wheel steering enables a pilot to:
 - a. taxi the aircraft on the ground
 - b. manoeuvre the aircraft in the air while the autopilot is engaged
 - c. alter the flight path while the autopilot is engaged by applying a breakout force
 - d. manoeuvre the aircraft with the autopilot disengaged.
3. Autopilot synchronisation in an aircraft:
 - a. requires that the interlocks are made before the autopilot will engage
 - b. ensures that, when the autopilot is engaged, the take-over is effected smoothly and without snatching on the control system
 - c. requires that the aircraft is trimmed out before the autopilot can be engaged
 - d. needs at least two alternators running in parallel.
4. The rules for the use of Autotrim are that it:
 - a. can be engaged without the autopilot
 - b. usually operates on all three axes
 - c. is not needed if the autopilot is engaged
 - d. operates only in conjunction with the autopilot.
5. The JAR OPS requirements for single pilot operation under IFR state that the aircraft must be fitted with:
 - a. single axis autopilot
 - b. a two axis autopilot
 - c. a three axis autopilot
 - d. a two axis autopilot with autothrottle
6. JAR 25 operational requirements for the installation of automatic pilot state that the system must have:
 - A. automatic synchronisation
 - B. quick release controls on both control wheels.
 - a. Only statement A is correct
 - b. Only statement B is correct
 - c. Both statements are correct
 - d. Neither statement is correct.

7. Consider the following statements regarding flight envelope protection:
- A High speed protection prevents the airspeed from exceeding V_{mo}/M_{mo}
B High angle of attack protection comes in when the aircraft reaches the stalling AoA
- a. Only statement A is correct
b. Only statement B is correct
c. Both statements are correct
d. Neither statement is correct.
8. The control laws for an autopilot are known as:
- a. normal law and emergency law
b. alternate law and direct law
c. normal, alternate and emergency laws
d. normal, alternate and direct laws.
9. An autoland system that, in the event of an autopilot failure, continues to function without degradation of performance beyond the limits required automatic, would be one with the status:
- a. fail passive
b. fail safe
c. fail operational
d. duplex.
10. The Autoland. sequence is considered to be complete when:
- a. reverse thrust is engaged
b. the autopilot is manually disengaged by the pilot
c. the aircraft touches down
d. the aircraft reaches the end of the runway.
11. The Autothrottle will come on automatically even with the A/T switch OFF when:
- a. in a FBW aircraft the AoA reaches a critical value called floor
b. the AoA reaches the stalling angle
c. TOGA button is pressed
d. reverse thrust is selected in flight.
12. An aircraft on Autopilot is engaged in the VOR mode and loses the VOR signals as it flies through the VOR cone of silence. The autopilot:
- a. automatically switches to Heading mode
b. decouples from the VOR and disconnects
c. tunes to the next VOR on the route
d. decouples from the VOR and flies the last heading for a fixed period.

13. For an aircraft with a non-synchronised autopilot system, 'snatching' of the controls by the autopilot when engaging or disengaging can be prevented by:
- the pilot ensuring that the aircraft is trimmed out before selecting or disengaging the autopilot
 - being in a straight and level position
 - disengaging the autotrim
 - switching on the yaw dampers.
14. With the autopilot in CWS the pilot manoeuvres the aircraft and releases control. The aircraft will maintain:
- heading and altitude
 - heading, speed and attitude
 - altitude and attitude
 - attitude at the time of release.
15. Autopilot corrections affecting Pitch are carried out by:
- autotrim only
 - autotrim and elevators
 - elevators only
 - autothrottle.
16. For a commercial aircraft operating with a single pilot in IFR the minimum requirement is that the autopilot should have control in:
- three axes
 - Heading mode
 - Altitude Hold and Heading mode
 - Altitude Hold, Heading mode and Speed.

ANSWERS - PAPER 1

1	D	21	A
2	B	22	B
3	C	23	C
4	A	24	A
5	B	25	A
6	A	26	C
7	A	27	C
8	A	28	C
9	B	29	C
10	B	30	B
11	C	31	A
12	C	32	D
13	D	33	D
14	B	34	D
15	B	35	B
16	B	36	C
17	D	37	B
18	C	38	B
19	D	39	C
20	A	40	D

ANSWERS - PAPER 2

- 1 A
- 2 B
- 3 B
- 4 D
- 5 B
- 6 B
- 7 D
- 8 D
- 9 C
- 10 B
- 11 A
- 12 D
- 13 A
- 14 D
- 15 B
- 16 C

ATPL GROUND TRAINING SERIES

Aircraft General Knowledge 4



Warning & Recording Systems

CHAPTER THIRTY THREE
FLIGHT WARNING SYSTEM

Contents

INTRODUCTION463
LEVELS OF ALERTS.463
WARNINGS IN GENERAL463
THE FLIGHT WARNING SYSTEM (FWS)465
FWS COMPONENTS466

INTRODUCTION

The purpose of the Flight Warning System (FWS) is to produce cautions and warnings for the crew to increase their situation awareness and to give them suitable indications of the action necessary to avoid impending danger.

The proliferation of various warning systems in today's aircraft poses a severe problem in that the crew could be confused by the multiplicity of warnings. It is therefore necessary to install an integrated flight warning system that will prioritize the warnings. By producing warnings relevant to a particular stage of flight and inhibiting other warnings the system enables the crew to respond to the warning posing the most immediate threat to safety.

LEVELS OF ALERTS

The alerting and warning system produces the following levels of alerts:

- **Warnings or Level A alerts.** These require immediate crew action. Warnings must attract the pilot's attention in sufficient time for appropriate action to be taken.
- **Cautions or Level B alerts.** These require immediate crew alertness and possible future action.
- **Advisories or Level C alerts.** These require crew alertness.

WARNINGS IN GENERAL

The alerting and warning messages are presented to the crew in visual, aural and sensory forms.

VISUAL

The level of alert is indicated by colours as follows:

- Warnings are presented in **Red**
- Cautions are shown in **Amber** or **yellow**
- Advisories are also shown in **Amber** or **yellow**

These visual indications can be presented in two different forms:

- **Electronic Screens.** Alerts and warnings appear in coloured text or symbols on various electronic screens (flight, navigation, engine and aircraft system displays).
- **Lights or Flags.** Red lights or reflective flags signify warnings and require remedial action if flight is to continue. An amber light or flag is used to indicate that a system or equipment is approaching a limit of normal function and that corrective action is necessary to prevent further deterioration and consequent failure.

Additionally, master warning and caution lights are normally provided and are located near the centre of scan in front of each pilot.

AURAL

An audible warning is mandatory if the pilot is required to assume control. This can be in a variety of forms depending upon the type of aircraft. The alert can be in the form of sounds or synthetic voice messages or a combination of both.

Warnings

Boeing aircraft produce the following aural warnings:

- A bell accompanies Fire messages
- A siren accompanies warnings on Cabin Altitude, Configuration and Overspeed
- A Wailer accompanies Autopilot disconnect
- Synthetic Voice messages for ground proximity, wind shear, airborne collision avoidance.

Airbus aircraft produce:

- continuous repetitive chimes (red warnings)
- cavalry charge (autopilot disconnect)
- Cricket sound (stall warning)
- Synthetic voice (GPWS, TCAS warnings)

Cautions

Beepers with various tones or chimes or musical chords are used to caution the crew to potential threats to safety.

SENSORY

A vibratory mode on the controls is used to indicate stall approach and demands immediate action to avert loss of control. In some aircraft a stick-pusher provides guidance to prevent a further deterioration of the situation that demanded the vibratory warning.

To rationalize warnings systems, a Master Warning Indicator light is often provided near the centre of scan. In older systems the crew member would then refer to a Master Warnings Panel where warnings were assembled in a rational order and annotated. In the modern Electronic Instrumentation Systems most of the alerts and warnings appear on appropriate electronic screens together with associated aural messages and master warning lights.

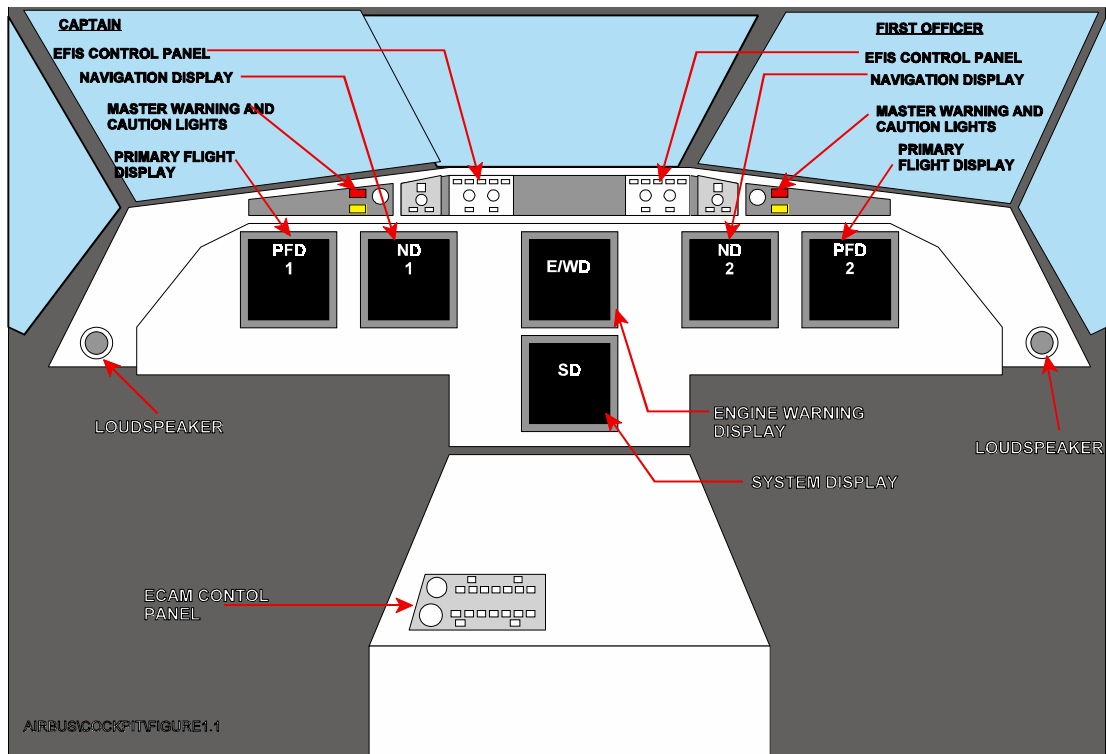

Figure 33.1 shows the cockpit displays and warnings of an Airbus A320.

THE FLIGHT WARNING SYSTEM (FWS)

General

The Flight Warning System generates alerts and warnings for the following situations:

- Engine and Airframe systems malfunctions
- Aerodynamic limits exceeded
- Presence of external Hazards.

Engine and Airframe systems malfunctions

These are dealt with in detail in the Engines and in the Systems sections of the course.

Aerodynamic limits

If aerodynamic limits are exceeded the FWS provides the following alerts to the crew:

- Altitude Alerting
- Overspeed Warning
- Stall Warning

These are dealt with in the next chapter.

External Hazard Warning

The external hazards that constitute a threat to aircraft safety are proximity to terrain and to other aircraft. These hazards can be avoided by the use of:

The Ground Proximity Warning System and

The Airborne Collision Avoidance System. These are dealt with in chapters 34 and 35.

FWS COMPONENTS

The FWS system comprises:

Inputs

There are inputs from various sources including hundreds of engine and airframe sensors, air data sensors, GPWS and ACAS systems.

A processing unit

This is made up of one or two flight warning computers.

Outputs

The outputs are classified either as alerts or as warnings and are generated according to the nature of the malfunction or threat to safety. Alerts can be visual (amber lights or text on VDU's) or aural (chimes or tones). Warnings are given in the form of red lights or by red text on electronic screens (steady or flashing) as well as aural signals (siren, bell, hooter). Additionally there are red and amber lights on the glare shield in front of the pilots to act as attention getters.

A block diagram of a Boeing 767 warning and alert system is shown at Figure 33.2.

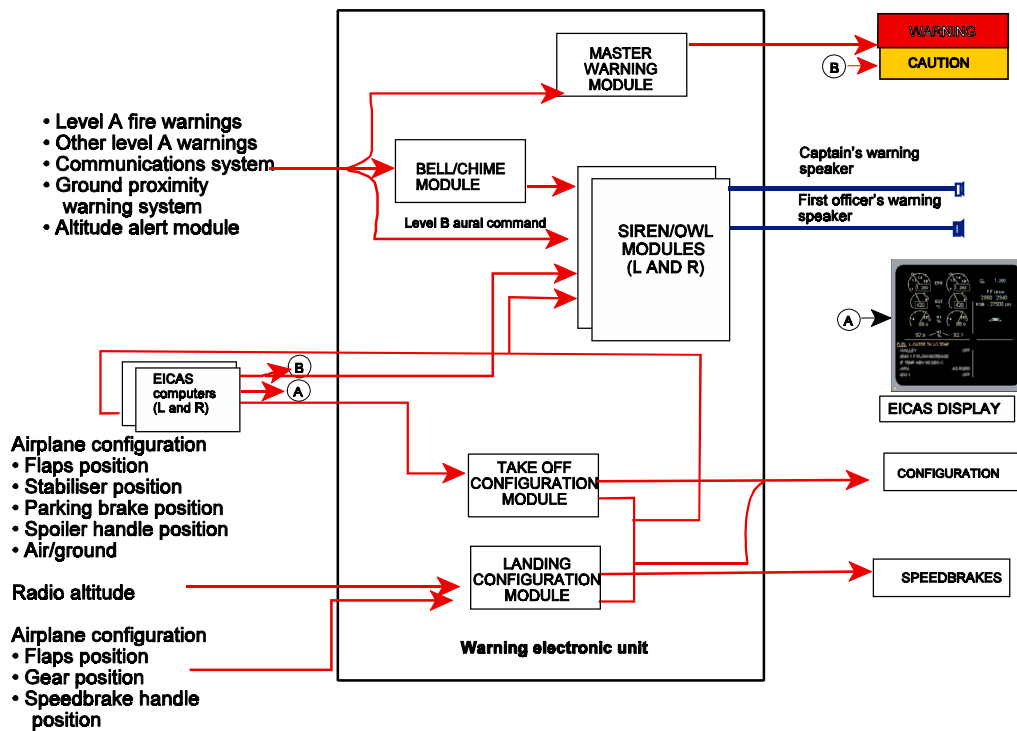

JARIDrawingsfw1.2

Figure 33.2 Warning and Alerting System (Boeing 767)

CHAPTER THIRTY FOUR
AERODYNAMIC WARNINGS

Contents

INTRODUCTION471
ALTITUDE ALERTING SYSTEM.471
OVERSPEED WARNING473
STALL WARNING SYSTEM475

INTRODUCTION

The Flight Warning System alerts the crew if there are deviations from certain aerodynamic parameters like altitude, airspeed and angle of attack. The system therefore provides the following alerts and warnings:

- Altitude Alerting System
- Overspeed Warning
- Stall Warning.

ALTITUDE ALERTING SYSTEM

Function

The function of the Altitude Alerting System is to warn the pilots that the aircraft is approaching or deviating from the altitude selected on the Autopilot control panel. It does this in certain height bands above and below the selected altitude.

Operation

The height bands within which altitude alerting operates are typically 300 feet to 900 feet for Boeing aircraft and 250 feet to 750 feet for Airbus aircraft. Figure 34.1. shows the operation of altitude alerting on a Boeing 747-400.

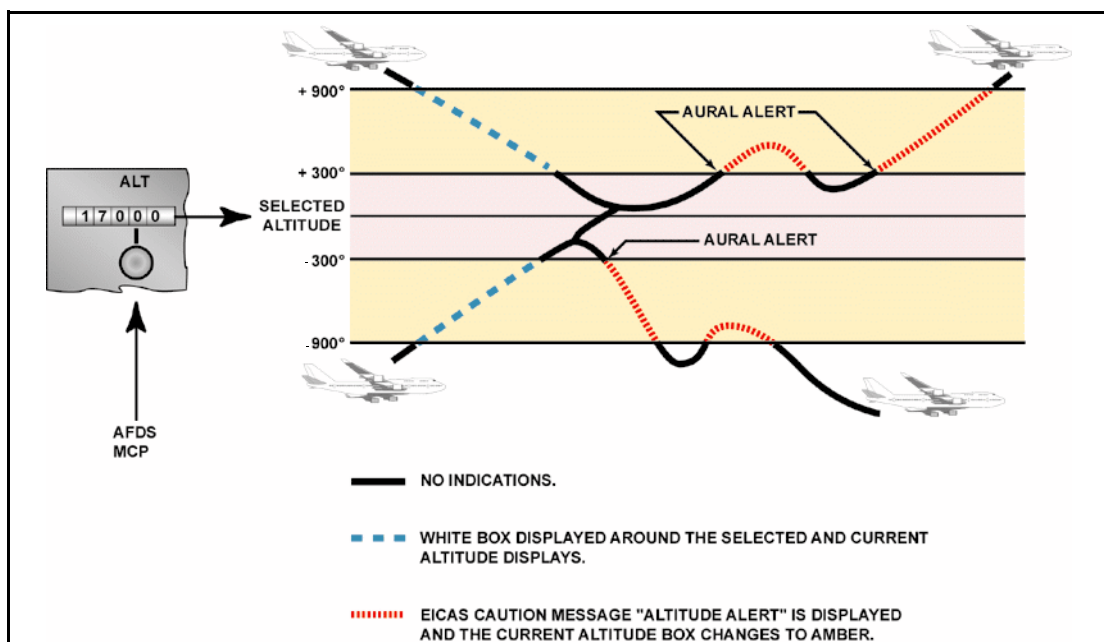

Figure 34.1 Altitude Alert (Boeing 747-400)

Approaching a selected altitude

At 900 feet prior to the selected altitude a white box will be displayed around the selected altitude and current altitude displays on the PFD.

At 300 feet prior to the selected altitude the white boxes disappear.

Deviation from selected altitude

At 300 feet from the selected altitude:

- Master caution lights illuminate
- Caution beeper sounds
- EICAS caution message ALTITUDE ALERT is displayed
- current altitude box changes to amber.

At 900 feet from the selected altitude, or on returning to within 300 feet from the selected altitude:

- Master caution lights extinguish
- EICAS caution message disappears
- Current altitude box changes to white

Block Diagram

Figure 34.2 shows a block diagram of a Boeing 767 altitude alerting system. When the aircraft approaches the selected altitude the advisory light on each electric altimeter illuminates. If the aircraft deviates by more than 300 feet from the selected altitude the system generates a level B warning (ie a caution) consisting of a level B message on the EICAS display, an alert tone from the speakers and illumination of the master caution (amber) light and the ALT ALERT light.

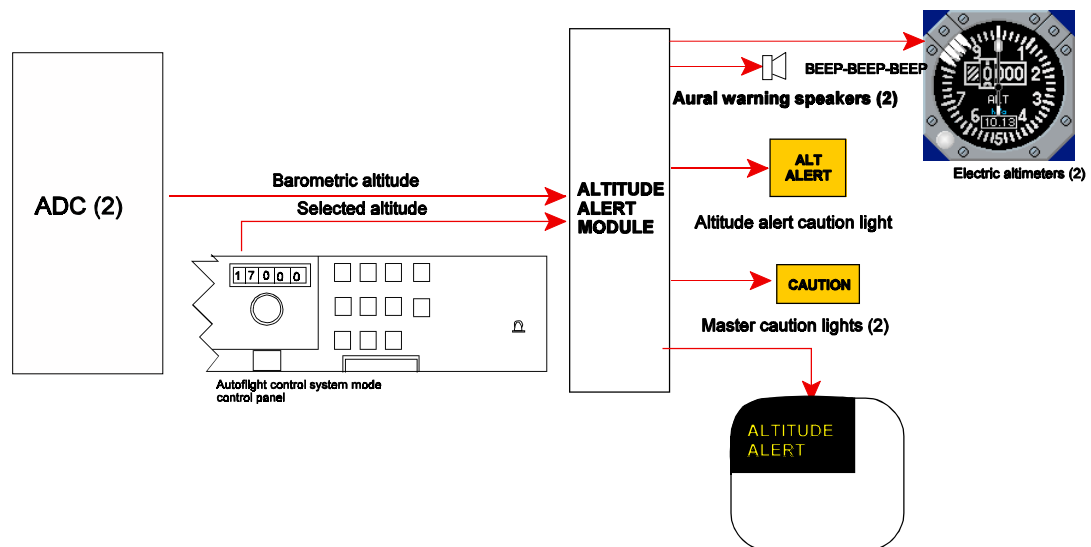

Figure 34.2 Altitude Alerting System (Boeing 767)

System inhibition

Altitude alerting is inhibited in flight whenever glideslope is captured or when landing flaps are selected with the gear down.

JAR OPS requirement

It is a requirement of JAR OPS that an aircraft is equipped with an altitude alerting system if it is:

- a turbine powered aircraft weighing more than 5700 kg **or** has more than 9 seats or
- a turbojet aircraft

The altitude alerting system must be capable of:

- alerting the crew on approaching the preselected altitude.
- alerting the crew by at least an aural signal when deviating above or below a pre-selected altitude.

OVERSPEED WARNING

Function

The purpose of the Overspeed warning system is to alert the flight crew if the airspeed exceeds the V_{mo} / M_{mo} limits calculated by the air data computer (ADC).

Operation

Whenever an overspeed situation occurs in an aircraft with electronic instrumentation the system:

- sounds the siren or horn
- illuminates the red master WARNING lights
- displays the message OVERSPEED on the EICAS upper display in red.

The warning continues while the overspeed situation exists and cannot be cancelled by depressing the red master WARNING light switch.

The system obtains its input from the air data computers (ADC's) via the flight warning system. It can be tested on the ground before flight by pressing a test switch which would then sound the siren or horn as appropriate for that aircraft.

In case of system failure the pilot would receive no warning if V_{mo} or M_{mo} is exceeded.

Displays

The maximum allowable speed is shown on the airspeed indicator by means of a barber's pole on a conventional meter and on the airspeed tape on the primary flight display or EADI of an EFIS display. These are shown in Figures 34.3 and 34.4. The barber's pole indicates the V_{mo} up until the M_{mo} (when expressed in terms of an indicated air speed, becomes limiting. The barber's pole will move counter-clockwise to indicate the maximum allowable speed. As altitude increases when climbing at a constant indicated airspeed the M_{mo} when expressed as an indicated airspeed will decrease.

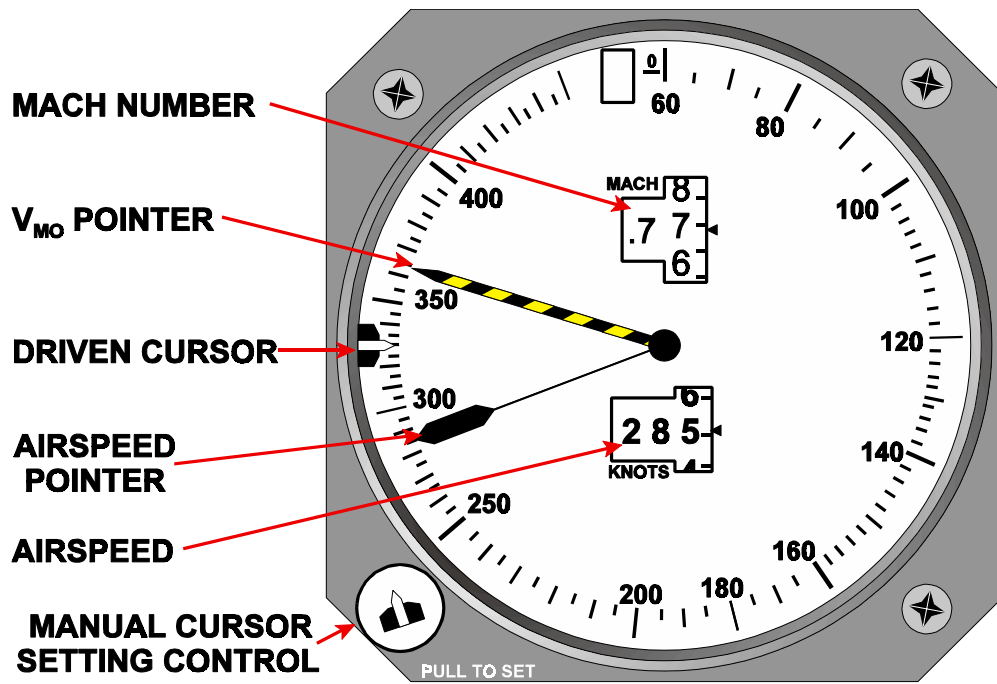

Figure 34.3 Conventional ASI with Vmo pointer

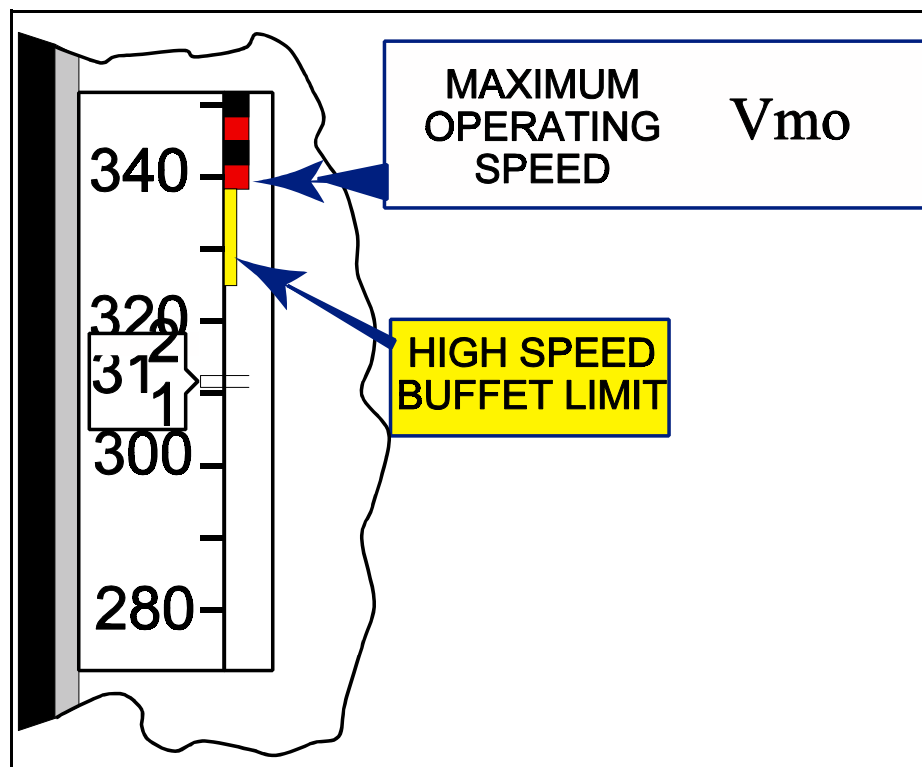

Figure 34.4 Overspeed Warning on PFD

STALL WARNING SYSTEM

Function

The purpose of the stall warning system is to warn the pilot of an impending stall. It does so when the aircraft approaches the stalling angle of attack for the current speed and configuration of the aircraft.

Stall Warning Systems

The simplest form of system, and one which is adopted in several types of small aircraft, consists of a hinged-vane-type sensor mounted in the leading edge of a wing so that the vane protrudes into the airstream. In normal level flight conditions, the airstream maintains the vane in line with the relative air flow. If the aircraft's attitude changes such that increases, then, by definition, the airflow will meet the leading edge at an increasing angle, and so cause the vane to be deflected. When reaches that at which the warning unit has been preset, the vane activates a switch to complete a circuit to an aural warning unit in the cockpit.

In larger types of aircraft, stall warning and prevention systems are designed to perform a more active function, such as 'stick-shaker' or 'stick-push or nudger' type.

The warning

The regulatory margin between the stall and the stall warning is 5 knots or 5% of the CAS whichever is the greater.

The warning provided can be in the form of tactile, aural or visual or a combination of these signals. Most aircraft have warning provided by stick-shakers which vibrate the control column as well as produce a rattling noise. In fly-by-wire systems the warning consists of a cricket (insect) sound, a synthetic voice STALL message and the red master WARNING light illumination.

The stall warning must continue until the angle of attack is reduced to approximately that at which the stall warning is initiated.

Operation

The stall warning module processes the signals from the various inputs to produce appropriate stall warning output signals. The system has the following inputs:

- angle of attack
- flap and slat positions
- landing gear weight-on position
- airspeed.

The angle of attack sensors are usually located on either side of the front fuselage. Sensing relays denote the positions of the flaps and slats. Since the pitch attitude of the aircraft is also changed by the extension of flaps or slats the angle of attack signal has to be modified when these are extended. During take-off when the nosewheel lifts off, microswitches operate to make the stall warning system active. The airspeed is usually derived from the ADC.

The output signals from the system can be applied to:

- a stick-shaker motor
- an angle of attack indicator
- aural warning
- synthetic voice warning
- red master WARNING light

Components

A block diagram of the component parts of a stall warning system and an angle of attack sensor are shown at Figures 34.5.

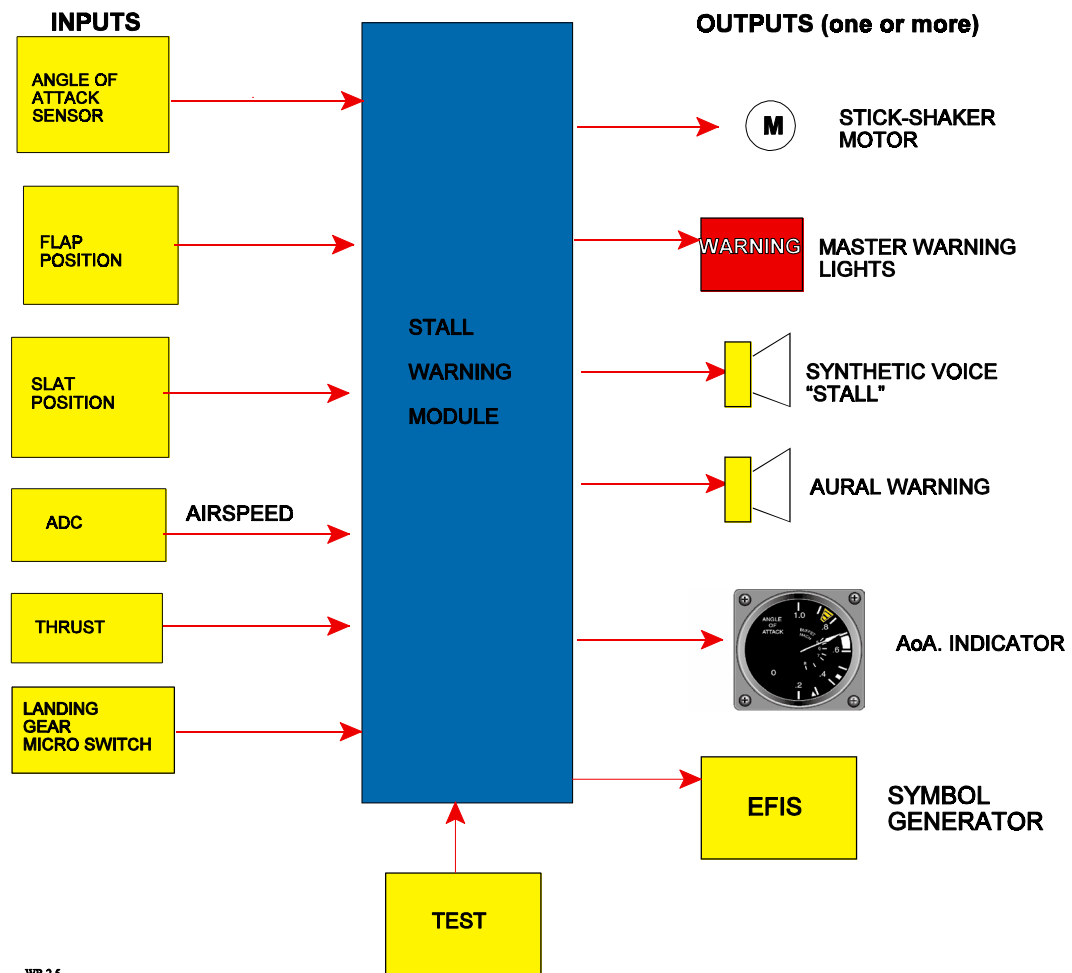

Figure 34.5 Components of a Stall Warning System

Angle of Attack Sensing

The angle of attack (AoA), or alpha (α) angle, also known as the aerodynamic incidence, is the angle between the chord line of the wing of an aircraft and the direction of the relative airflow, and is a major factor in determining the magnitude of lift generated by a wing. Lift increases as it increases up to some critical value at which it begins to decrease due to separation of the slow-moving air (the boundary layer) from the upper surface of the wing, which, in turn, results in separation and turbulence of the main airflow. The wing, therefore, assumes a stalled condition, and since it occurs at a particular angle rather than a particular speed, the critical AoA is also referred to as the stalling angle. The angle relates to the design of aerofoil section adopted for the wings of any one particular type of aircraft, and so, of course, its value varies accordingly; typically it is between 12° and 18° for straight wings but maybe as high as 30° or 40° for swept or delta wings.

Alpha Probes

The two types in current use are the conical slotted probe and the vane detector; the conical slotted probe is shown in Figure 34.6 and the vane type in Figure 34.7. The vane detector is a counter-balanced aerodynamic vane which positions the rotor of a synchro. Both types are protected against ice formation by a heater.

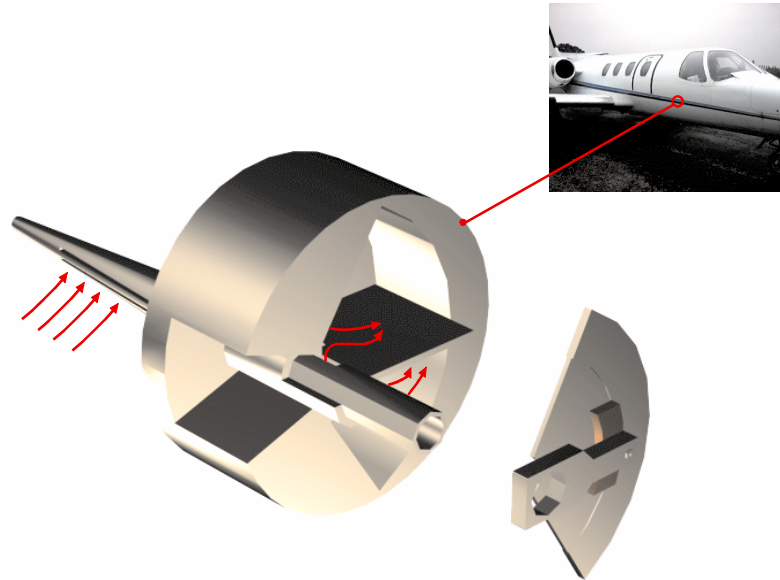

Figure 34.6

The conical probe extends through the aircraft skin perpendicular to the flow of air. The probe is attached to a paddle inside the transmitter housing. The probe and paddle are free to rotate. Two sets of slots in the probe allow pressure variations, caused by changes in airstream direction, to be transmitted through separate air passages to opposite sides of a paddle chamber. When the pressure acting on one side of a paddle is greater than the pressure on the other side, the paddle and probe rotate until the pressures are equal. The probe thus positions itself to determine the angle of attack of the aircraft. The probe also drives the electrical pick offs such as potentiometers or synchros.

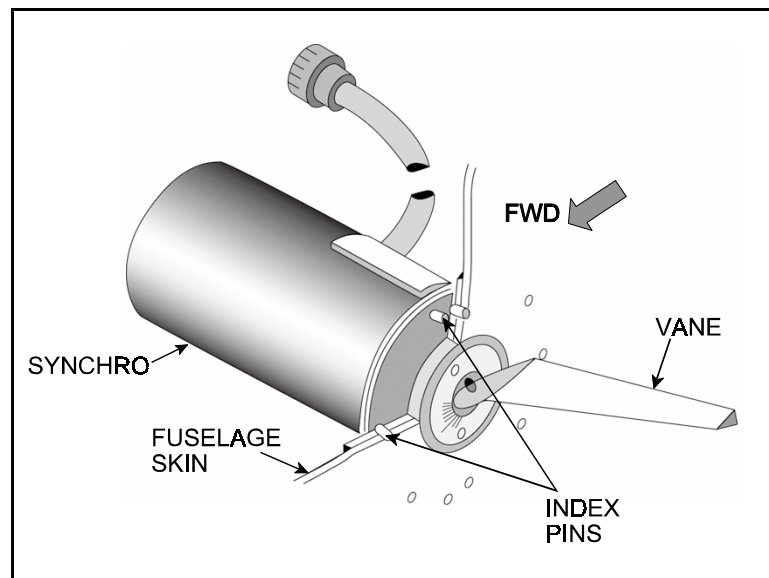

Figure 34.7 Angle of attack sensor

Angle of Attack Indicators.

These may be fitted in addition to the stall warning system. A simple schematic lay-out of the installation is shown in Figure 34.8.

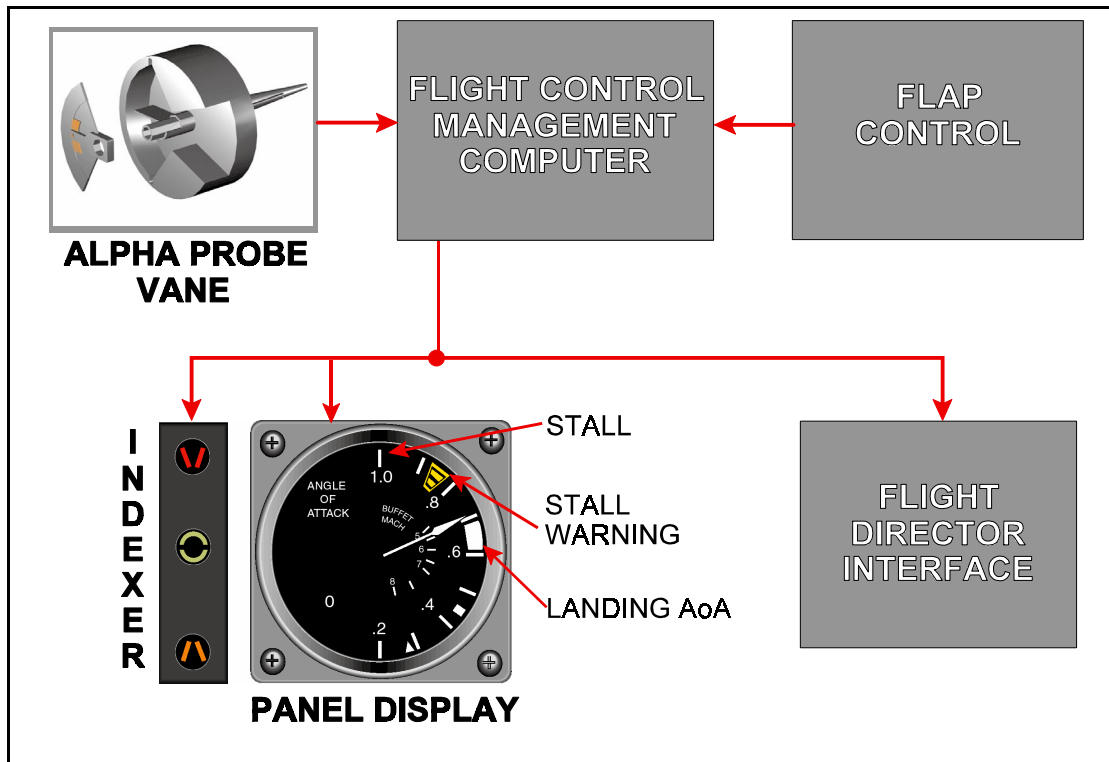

Figure 34.8

CHAPTER THIRTY FIVE

GROUND PROXIMITY WARNING SYSTEM (GPWS)

Contents

INTRODUCTION 481

DEFINITIONS 481

BOEING 737 MARK II EGPWS 482

A TABLE OF THE EGPWS OPERATING MODES 483

MODE 1 - EXCESSIVE BAROMETRIC DESCENT RATE 484

MODE 2 - EXCESSIVE TERRAIN CLOSURE RATE 486

MODE 3 - ALTITUDE LOSS AFTER TAKE-OFF OR GO-AROUND 488

MODE 4A - UNSAFE TERRAIN CLEARANCE WITH
LANDING GEAR NOT DOWN 490

MODE 4B - UNSAFE TERRAIN CLEARANCE WITH
FLAPS NOT IN LANDING CONFIGURATION 492

MODE 5 - BELOW GLIDE SLOPE DEVIATION ALERT 494

MODE 6A - BELOW SELECTED MINIMUM RADIO ALTITUDE 496

MODE 6B ALTITUDE CALL-OUTS AND BANK ANGLE ALERT 497

MODE 7 WINDSHEAR ALERTING. 498

ACTION TO BE TAKEN ON RECEIVING A WARNING. 499

ENHANCED GROUND PROXIMITY WARNING SYSTEM (EGPWS) 500

TERRAIN AWARENESS SYSTEM (TAWS) 500

TERRAIN CLEARANCE FLOOR 503

INTEGRITY TESTING. 503

INHIBITION OF EGPWS MODES 503

QUESTIONS 505

ANSWERS 508

INTRODUCTION

The aim of the system is to give **visual and audible warning** signals to a pilot when the aircraft's **proximity to the terrain poses a potential threat to its safety**. Although not a foolproof means of preventing a collision with the earth's surface, **EGPWS enhances flight safety** and can prevent those accidents which could result from crew errors or distraction, malfunction or misinterpretation of navigational equipment, or inappropriate ATC instructions.

Figure 35.1 shows the three elements of a GPWS: inputs, outputs and a central processing unit. The Central Processing Unit will also indicate a computer failure and any failures of the six input signals. The system operates between **50' and 2450' actual height above the surface** and automatically selects the correct mode of operation.

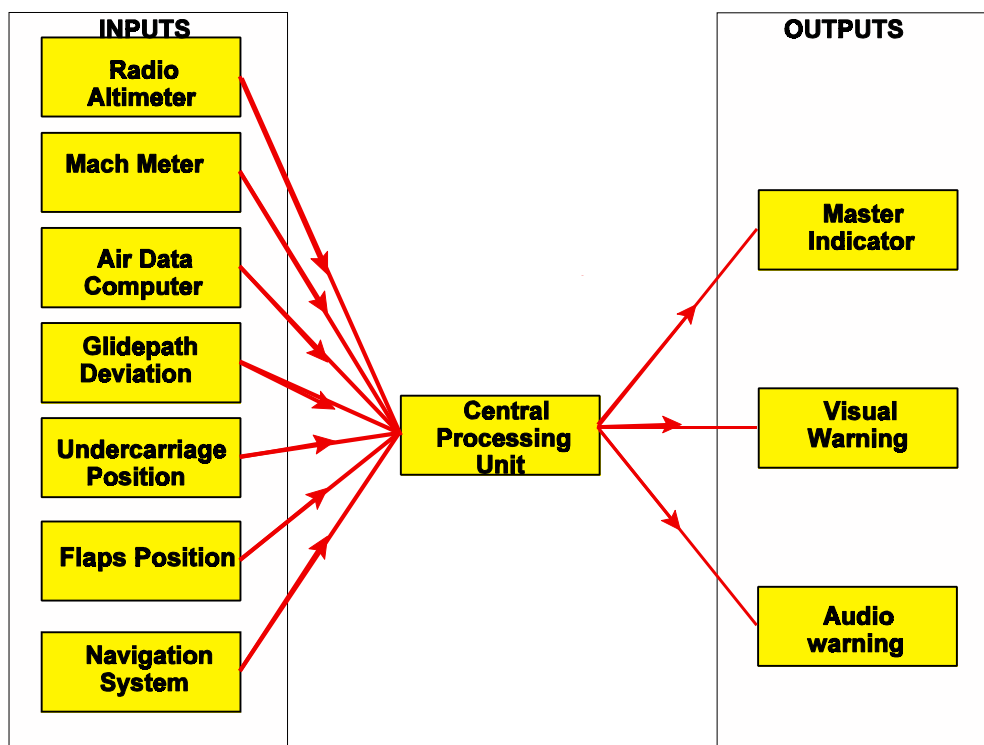

Figure 35.1

DEFINITIONS

ALERT: A **caution** generated by the EGPWS equipment.

WARNING: A **command** generated by the EGPWS equipment.

Types of Warnings/Alerts

Genuine

The equipment provides a warning in accordance with its technical specification.

Nuisance

The equipment provides a warning in accordance with its technical specification, but the pilot is flying an accepted safe procedure.

False

A fault or failure in the system causes the equipment to provide a warning that is not in accordance with its technical specification.

BOEING 737 MARK II EGPWS

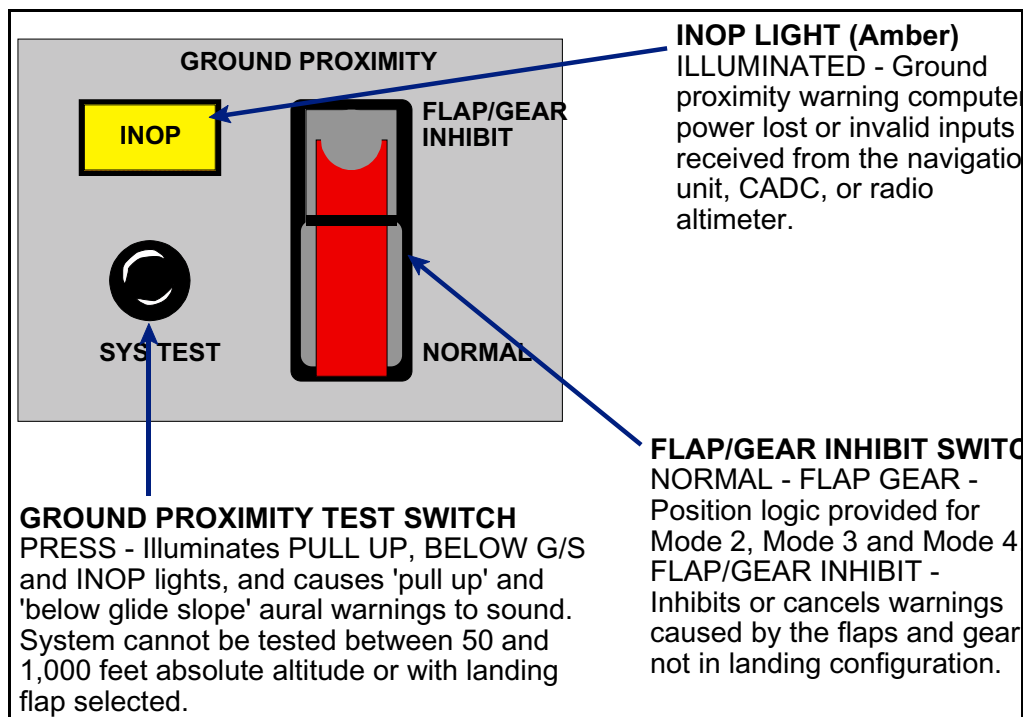
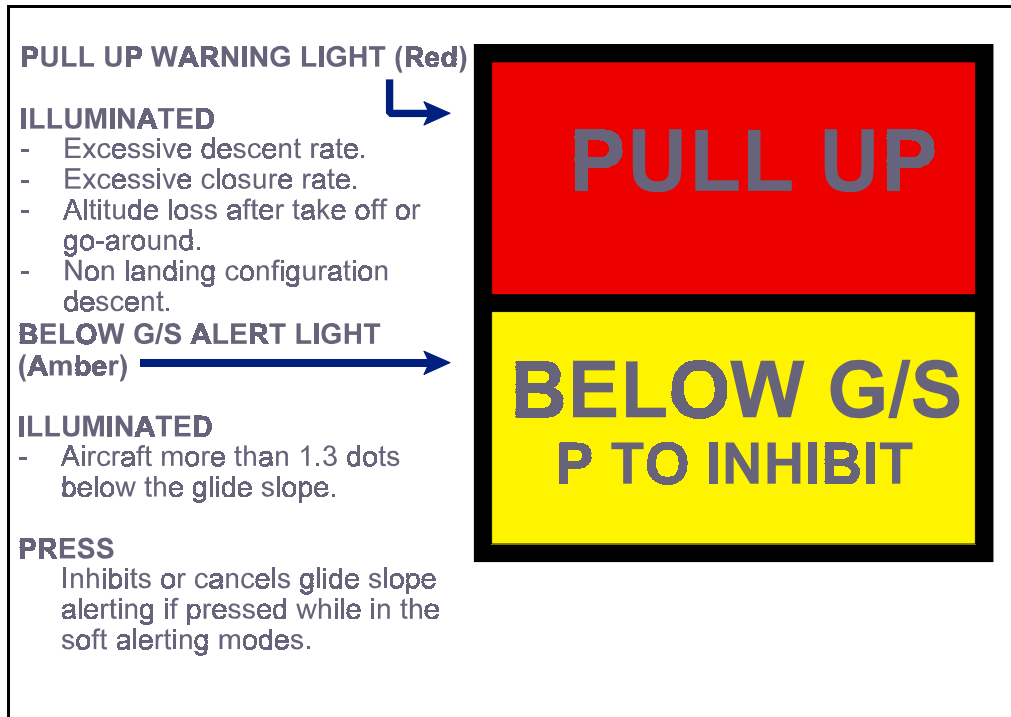

Figure 35.2 First Officer's Instrument Panel.

A TABLE OF THE EGPWS OPERATING MODES

GPWS MODE		ADVANCED EQUIPMENT Alert	Warning
1. Excessive descent rate		'Sink Rate'	'Whoop Whoop Pull Up'
2. Excessive terrain closure rate		'Terrain Terrain'	'Whoop Whoop Pull Up'
3. Altitude loss after take-off or go-around		'Don't Sink'	-
4. Unsafe terrain clearance while not in the landing configuration	4A. Proximity to terrain - Gear not locked down	'Too Low gear'	'Too Low Terrain'
	4B. Proximity to terrain - Flaps not in a landing position	'Too Low Flaps'	'Too Low Terrain' (see note below)
5. Descent below glide-slope		'Glideslope'	-
6. Descent below 'minimums'	6A.	'Minimums'	-
	6B.	'Bank angle'	-
7. Windshear warning		-	'Wind Shear'

Note: Although some manufacturers of GPWS equipment may show in their literature 'Too Low Terrain' to be an alert, the view of the CAA is that the response to this should be as for a warning.

MODE 1 - EXCESSIVE BAROMETRIC DESCENT RATE

Mode 1 has two boundaries and is independent of aircraft configuration. Penetration of the **first boundary** generates an aural alert of **"SINK RATE"** repeated each 1.5 seconds.

Penetrating the **second boundary** causes the repeated warning of **"WHOOOP, WHOOP PULL UP"**, until the rate of descent has been corrected.

MODE 1

AURAL ALERT - SINK RATE, SINK RATE

AURAL WARNING - 'WHOOOP WHOOP PULL UP' VISUAL - PULL UP

MODE 1

AURAL ALERT - SINK RATE, SINK RATE
AURAL WARNING - 'WHOOOP WHOOP PULL UP'

VISUAL - **PULL UP**

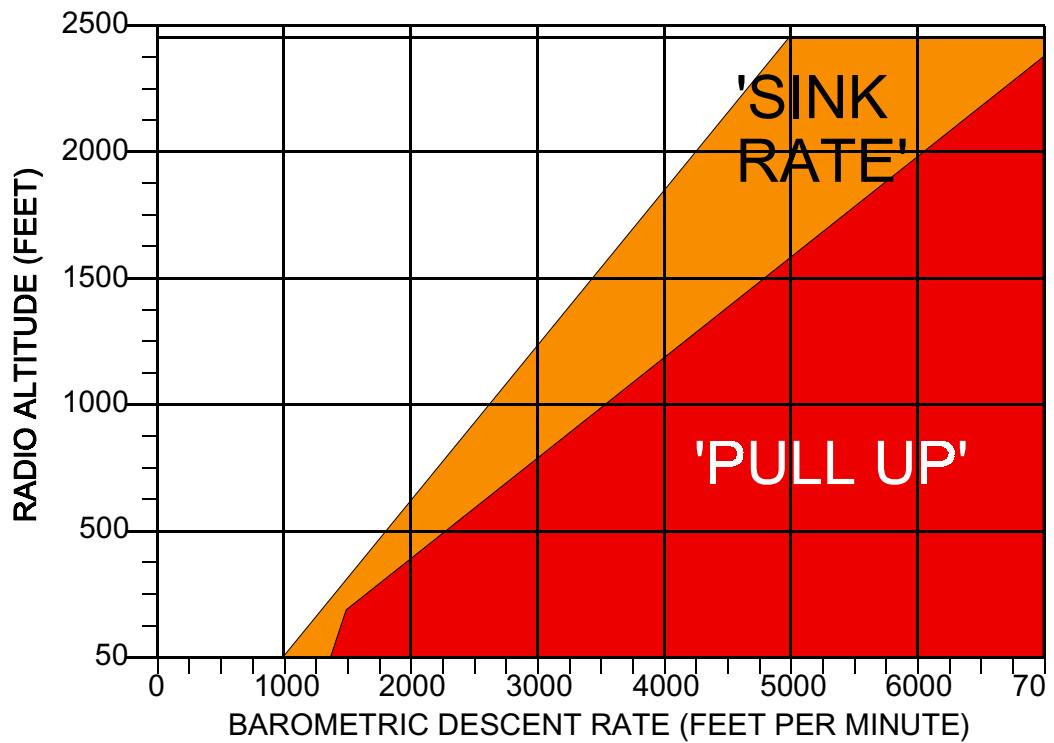
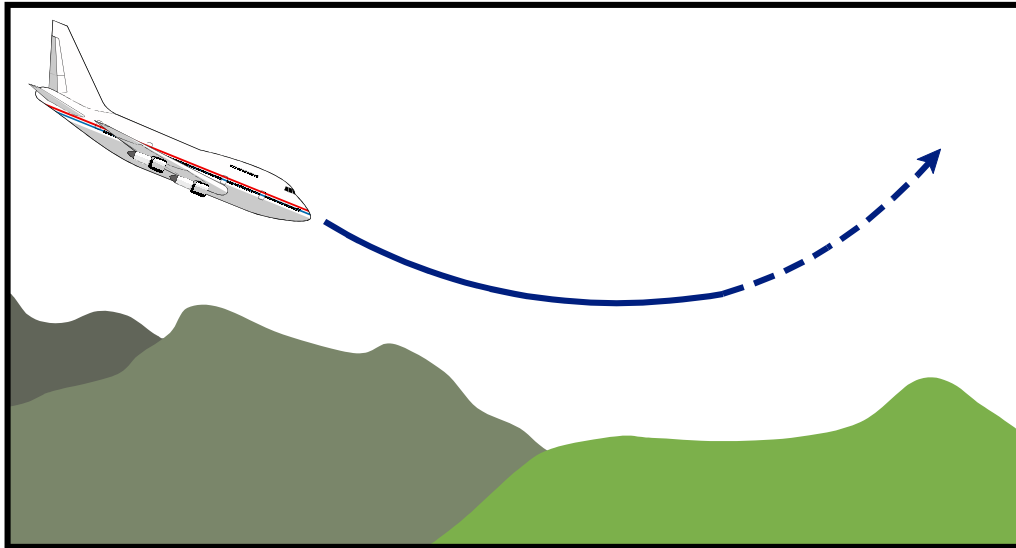

Figure 35.3 MODE 1

MODE 2 - EXCESSIVE TERRAIN CLOSURE RATE

Mode 2 monitors **Mach number, radio altitude rate of change, barometric altitude and aircraft configuration.**

Mode 2 has two boundaries. Penetrating the **first boundary** causes an **aural alert** of "TERRAIN, TERRAIN", **followed by the repeated aural warning "WHOOOP, WHOOP PULL UP"**. After leaving the PULL UP area, the repeating TERRAIN message will again be heard while in the terrain portion of the envelope. If both boundaries are penetrated while in the landing configuration, only the repeating TERRAIN aural alert will occur. The terrain message is repeated each 1.5 seconds.

As Mach number increases from 0.35 to 0.45 with gear up, the highest radio altitude at which Mode 2 alert warning will occur is increased to 2450 feet. This higher portion of the envelope is inhibited with the flap override switch in the FLAP OVRD position.

MODE 2

AURAL ALERT - 'TERRAIN, TERRAIN'

AURAL WARNING - 'WHOOOP WHOOP PULL UP'

VISUAL - PULL UP

MODE 2

AURAL ALERT - 'TERRAIN, TERRAIN'
AURAL WARNING - 'WHOOO WHOOP PULL UP'

VISUAL -

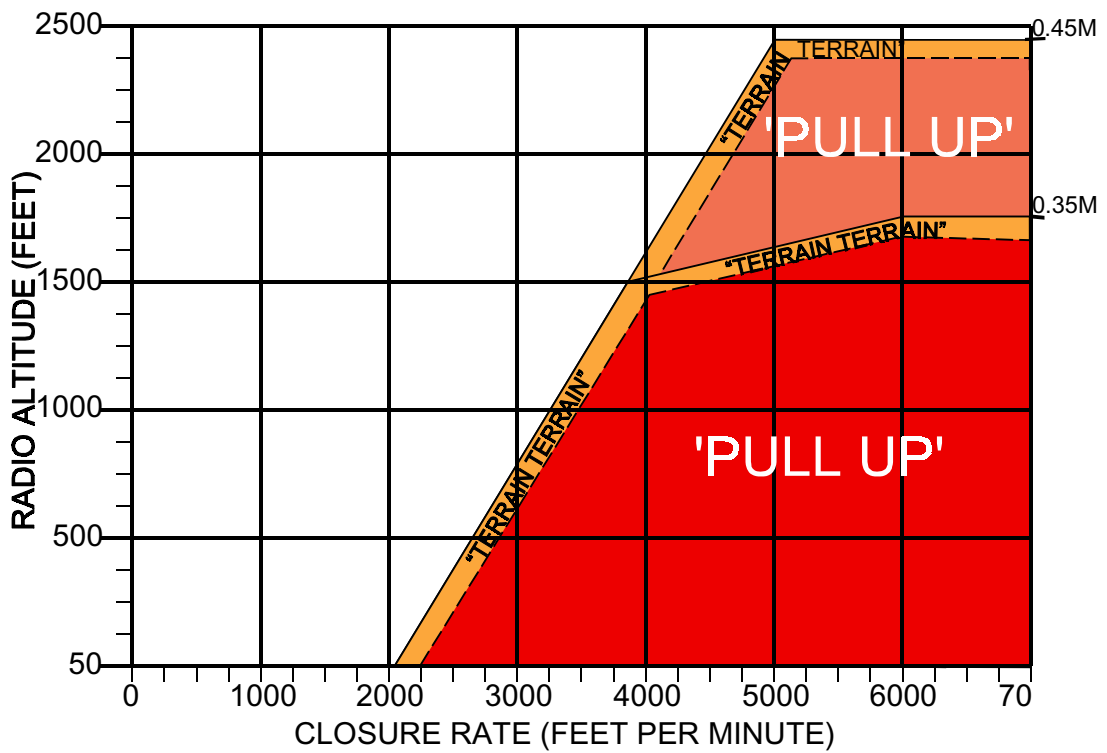
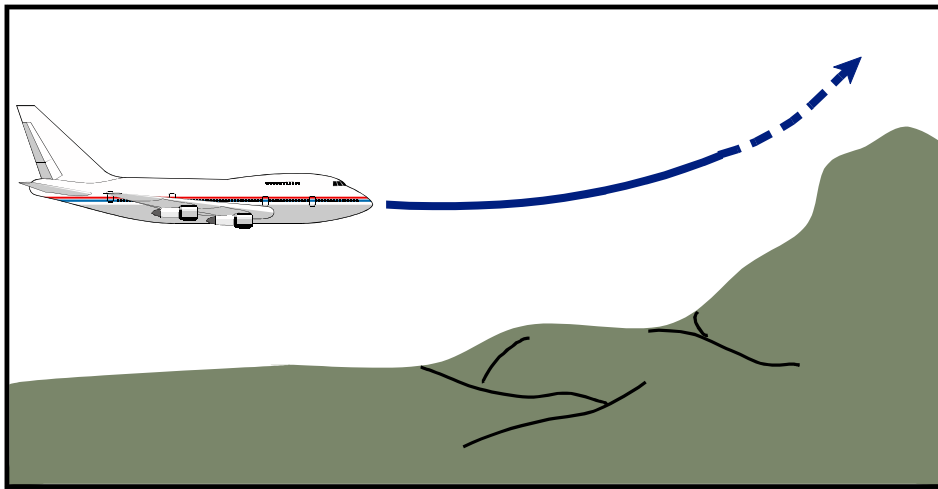

Figure 35.4 MODE 2

MODE 3 - ALTITUDE LOSS AFTER TAKE-OFF OR GO-AROUND

Mode 3 provides an alert if a descent is made during initial climb or go-around. The aural alert is a voice message of "DON'T SINK", repeated each 1.5 seconds until the flight condition is corrected.

Mode 3 is effective between **50 and 700 feet** radio altitude and generates the alert when the accumulated barometric loss equals approximately **10 percent** of the existing radio altitude.

Mode 3 does not **arm during the descent until below 200 feet** radio altitude.

MODE 3

AURAL ALERT - "DON'T SINK"

VISUAL - PULL UP

MODE 3

AURAL ALERT - "DON'T SINK"

VISUAL -

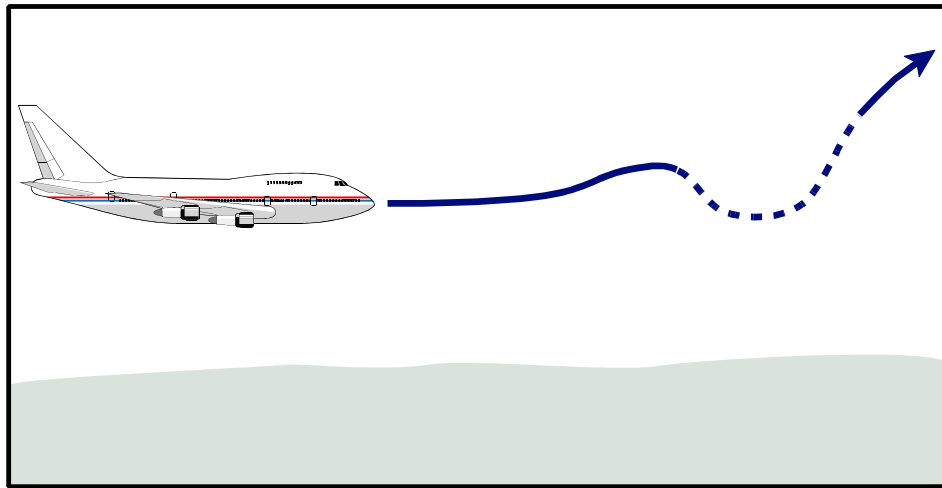

Note Mode 3 arms when the aeroplane descends below 200ft in the landing configuration

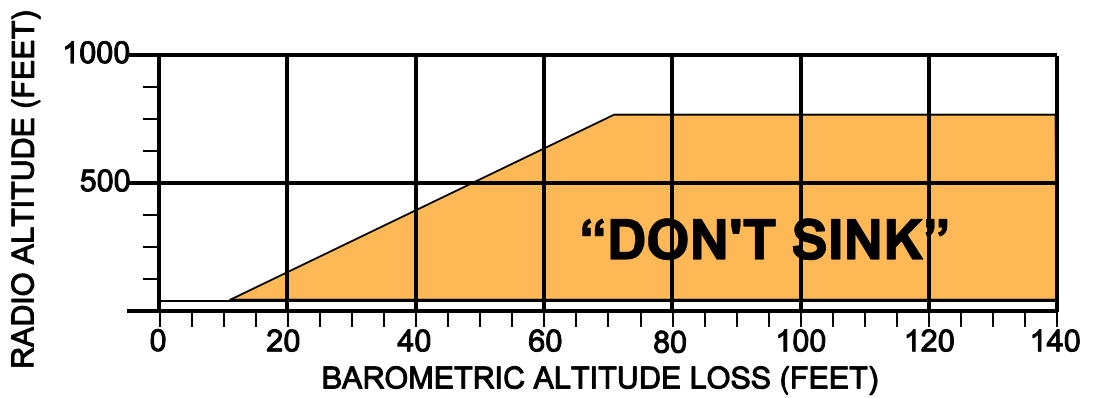

Figure 35.5 MODE 3

MODE 4A - UNSAFE TERRAIN CLEARANCE WITH LANDING GEAR NOT DOWN

The terrain clearance mode with gear retracted, is **armed after take-off upon climbing through 700 feet radio altitude.**

When this envelope is penetrated **at less than 0.35 Mach**, the aural alert **“TOO LOW GEAR”** is sounded. When the envelope is penetrated **at more than 0.35 Mach**, the aural alert **“TOO LOW TERRAIN”** is sounded and the **upper boundary of the envelope is increased to 1000 feet radio altitude.** The applicable voice message is repeated each 1.5 seconds until the flight condition has been corrected.

MODE 4A

AURAL ALERT -“TOO LOW GEAR” or “TOO LOW TERRAIN”

VISUAL - PULL UP

MODE 4A

AURAL ALERT - "TOO LOW GEAR"
"TOO LOW TERRAIN"

VISUAL - PULL UP

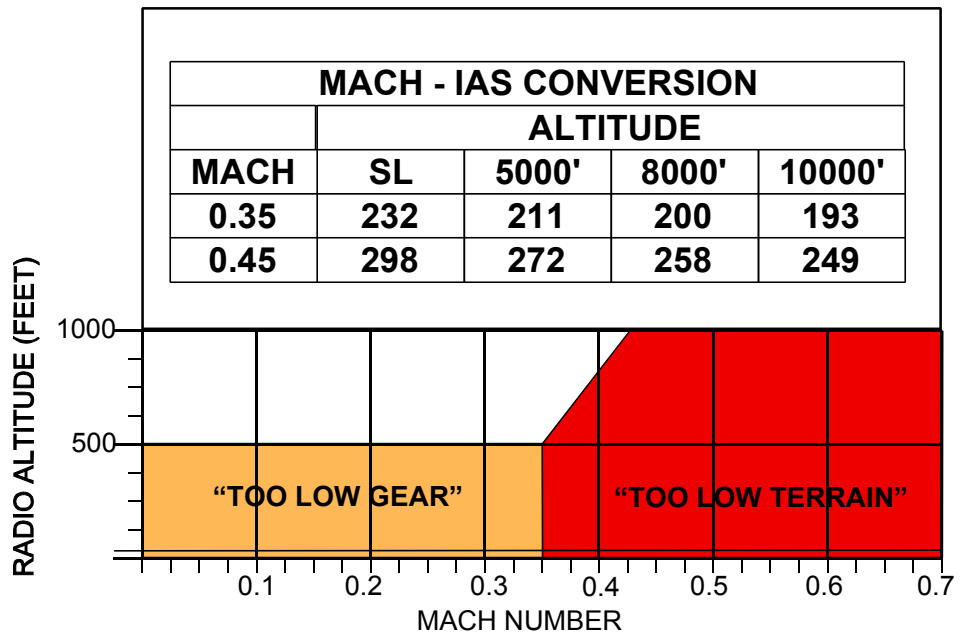
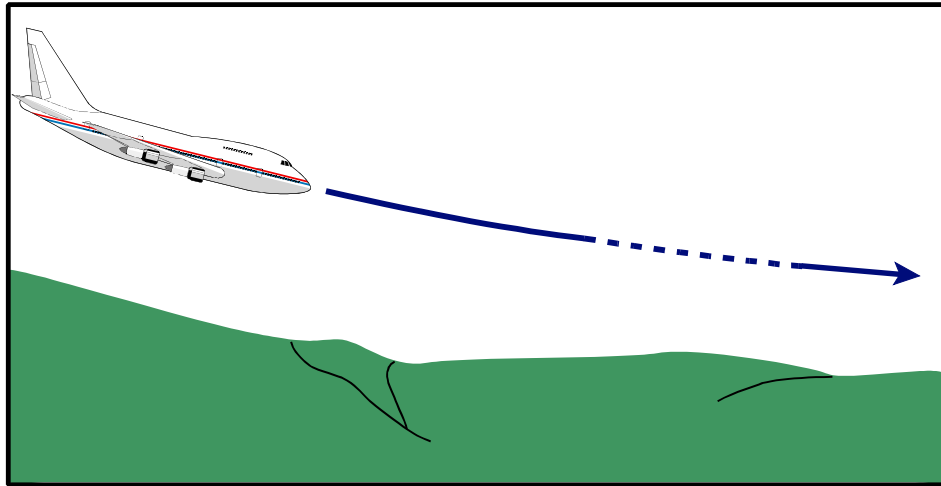

Figure 35.6 MODE 4A

MODE 4B - UNSAFE TERRAIN CLEARANCE WITH FLAPS NOT IN LANDING CONFIGURATION

This mode provides an alert **when the gear is down** and the **flaps are not in the landing position**. If the envelope is penetrated at **less than 0.28 Mach** with the flaps not in the landing position, the aural alert of **“TOO LOW FLAPS”** is sounded.

When the envelope is penetrated **at more than 0.28 Mach**, the aural alert of **“TOO LOW TERRAIN”** is sounded and the upper boundary of the envelope is increased **to 1000 feet radio altitude**.

The applicable voice message is repeated each 1.5 seconds until the flight condition has been corrected. **The “TOO LOW GEAR” alert takes priority over the “TOO LOW FLAPS”**. The too low flaps alert and associated too low terrain alert are **inhibited** with the flap inhibit switch in the **FLAP OVRD** position.

MODE 4B

AURAL ALERT - “TOO LOW FLAPS” or “TOO LOW TERRAIN”

VISUAL - PULL UP

MODE 4B

AURAL ALERT - "TOO LOW FLAPS"
"TOO LOW TERRAIN"

VISUAL -

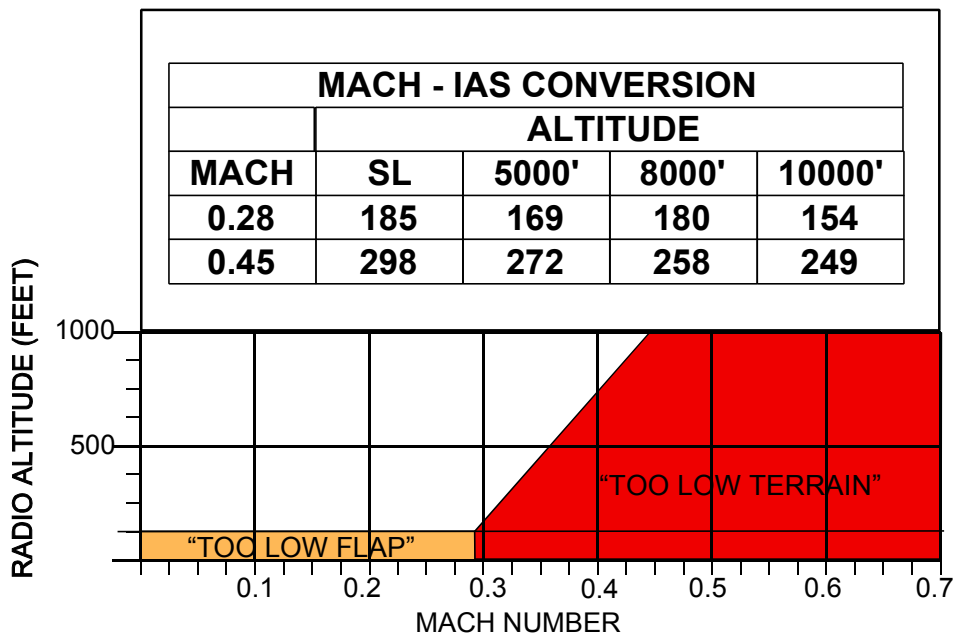
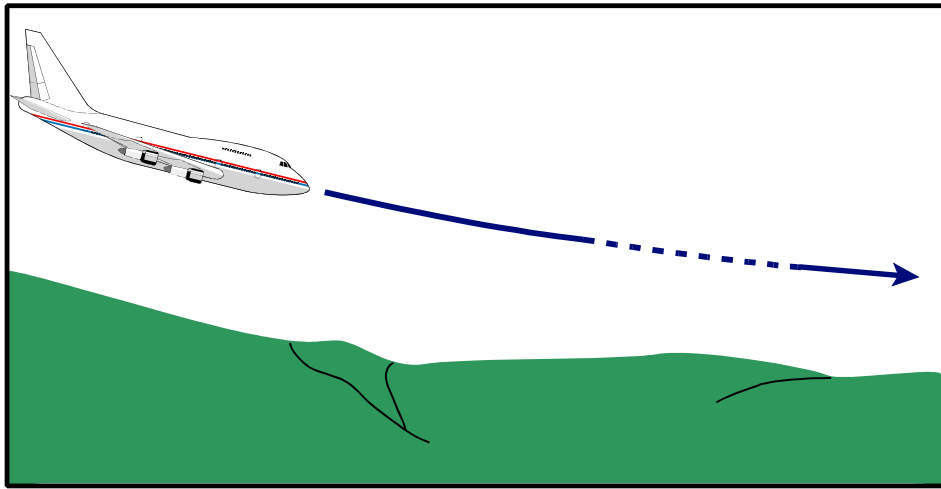

Figure 35.7 MODE 4B

MODE 5 - BELOW GLIDE SLOPE DEVIATION ALERT

This mode alerts the flight crew of a descent of **more than 1.3 dots below an ILS glide slope**. The envelope has two areas of alerting, **soft** and **loud**. In both areas, the alert is a repeated voice message of **"GLIDE SLOPE"**, and illumination of both pilots' **BELOW G/S'** lights. The voice message amplitude is increased when entering the loud area. In both areas, the voice message repetition rate is increased as the glide slope deviation increases and the radio altitude decreases. The mode is armed when a valid signal is being received by the captain's glide slope receiver and the radio altitude is **1000 feet or less**.

The mode may be cancelled or inhibited by pressing either pilot's **below G/S** light while below 1000 feet radio altitude. The mode will re-arm when climbing above 1000 feet radio altitude. **Mode 1 to 4 aural alerts and warnings have priority over mode 5 aural alerts**, however both **PULL UP** and **BELOW G/S** lights could be illuminated at the same time.

MODE 5

AURAL ALERT - "GLIDE SLOPE"

VISUAL - BELOW G/S P TO INHIBIT

MODE 5

AURAL ALERT - "GLIDE SLOPE"
"

VISUAL -

BELOW G/S
P TO INHIBIT

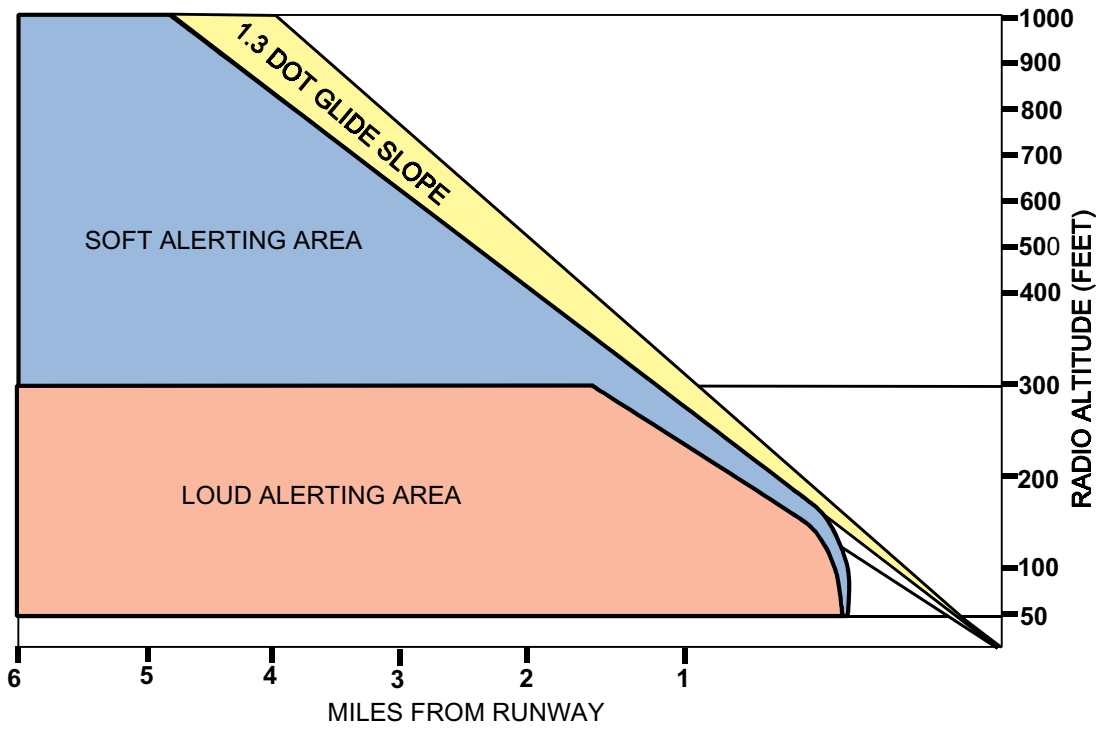
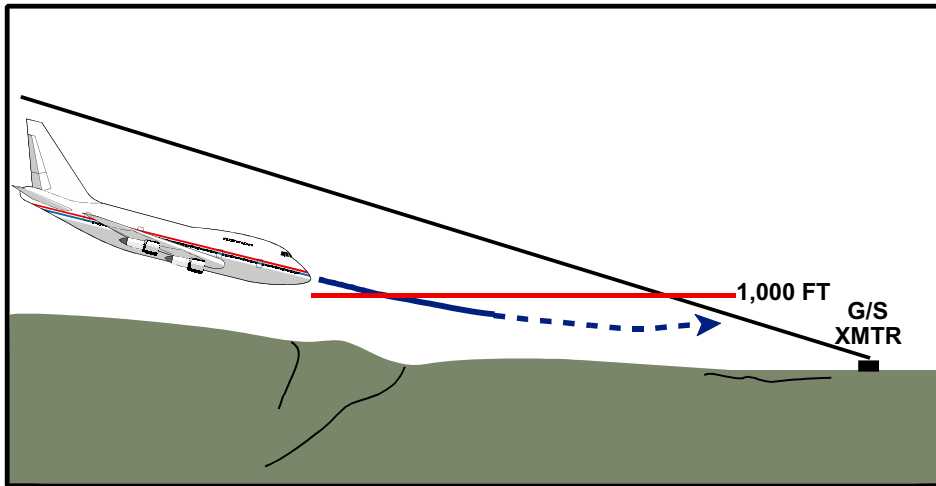

Figure 35.8 MODE 5

MODE 6A - BELOW SELECTED MINIMUM RADIO ALTITUDE

Mode 6A provides an **aural alert** if a descent is made below the minimum decision altitude cursor in the captain's radio altimeter. This mode operates **between 50 and 1000 feet** of radio altitude.

This alert is aural only and consists of "MINIMUMS, MINIMUMS" sounded once.

The mode is rearmed when the radio altitude becomes greater than that selected with the captain's altitude cursor.

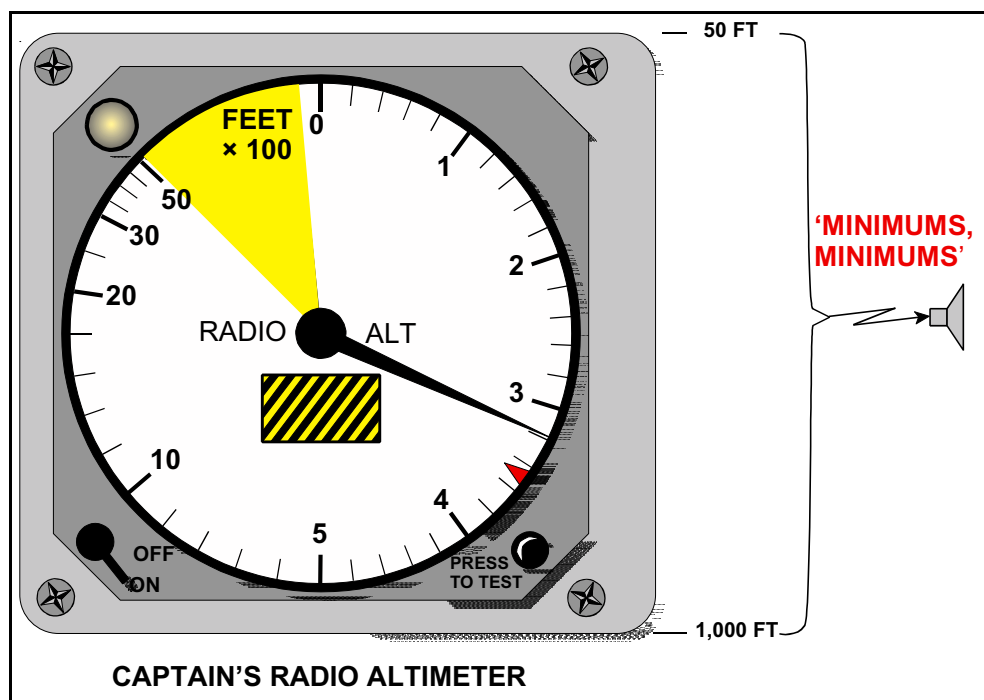

Figure 35.9 Mode 6

MODE 6B ALTITUDE CALL-OUTS AND BANK ANGLE ALERT

Call-outs of selected altitudes and minimums is available. The call outs used are a customer option but for example may consist of calls at 200ft and 100ft to decision height, or absolute height call outs from the radio altimeter with respect to the ground.

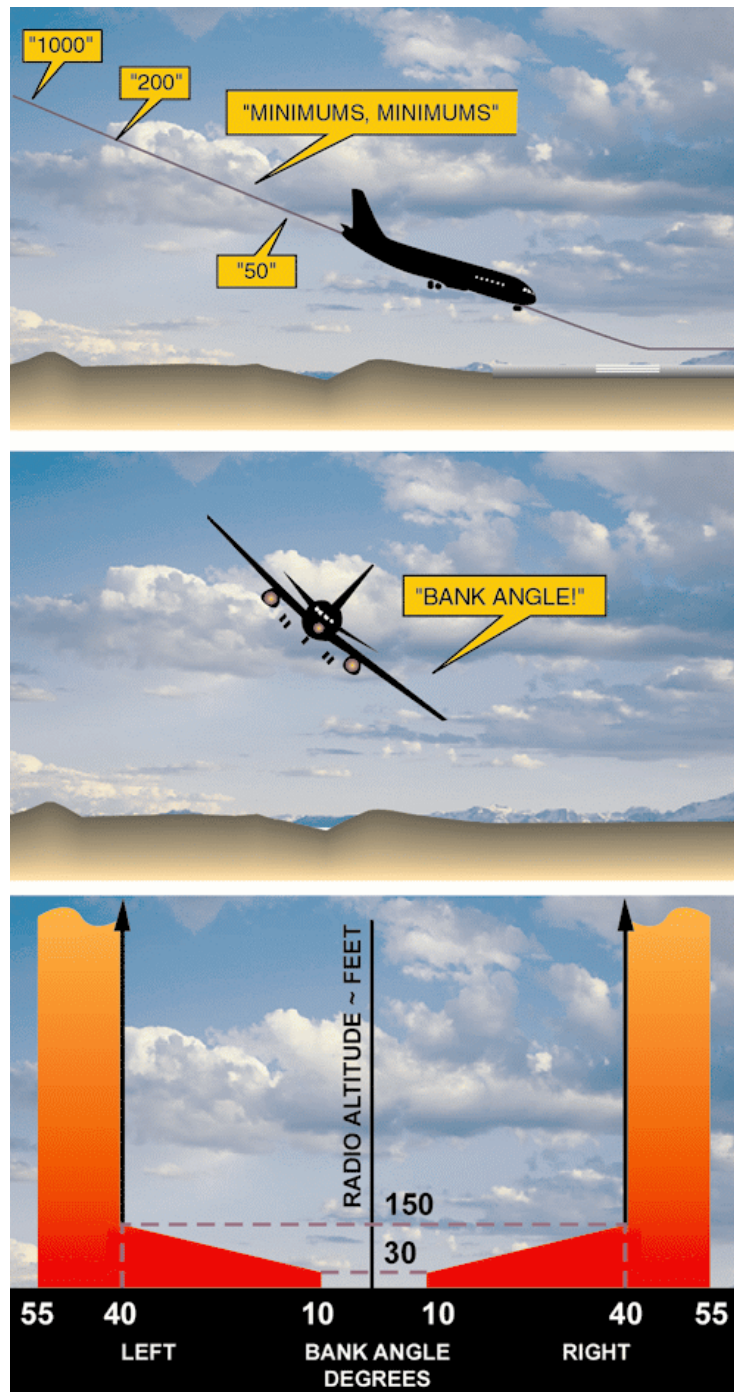

Figure 35.10 Mode 6B

“BANK ANGLE” can be used to alert crews of excessive roll angles. The bank angles will be specific to each aircraft. The bank angle limit reduces with proximity to the ground due to the reduced wing tip clearance to prevent wing tip or engine damage during take off and landing.

MODE 7 WINDSHEAR ALERTING

Visual and aural windshear warnings are given when several parameters such as ground speed, airspeed, barometric height and rate of descent and radio altitude, indicate the initial conditions of entering an area of windshear. Again as with the terrain threat display there is no scanning beam looking ahead to avoid the condition entirely. Rather the benefit from the system is derived from the fact that it allows the pilot to initiate the windshear go-around procedure earlier, giving the aircraft a greater probability of avoiding an accident.

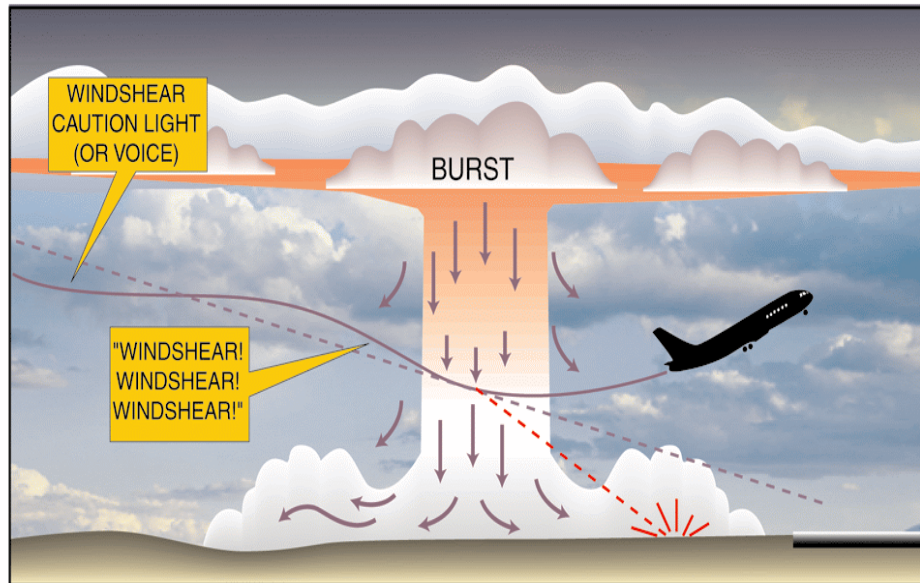

Figure 35.11 Mode 7 Windshear Alerting

ACTION TO BE TAKEN ON RECEIVING A WARNING

The response to all alerts or warnings should be **positive and immediate**: establishing the cause of EGPWS activation should take second place.

There is a risk that repeated experience of unwanted alerts/warnings may reduce confidence in the system. Hence, **flight crews should report ALL alerts/warnings to the operator** thereby ensuring that appropriate analysis and remedial action can be taken. There is a GPWS operation reporting form for this purpose.

The immediate response must be to **level the wings and to initiate a maximum gradient climb** which should be maintained until the aircraft attains the **minimum safe altitude** for that part of the route being operated. Modification is permissible only in exceptional circumstances such as the necessity to follow a curved path for azimuth terrain avoidance.

When established in the climb every effort shall be made to determine the cause of the warning and to verify the aircraft's position. **The only circumstances when a climb to this altitude may be discontinued are when:**

- The cause of the warning has been positively identified and the warning ceases,
- or**
- The conditions of CAP516 apply ie:
 - The aircraft is operated by day in meteorological conditions which will enable the aircraft to remain 1nm horizontally and 1000ft vertically away from cloud and an in-flight visibility of at least 5nm;
- and**
- It is immediately obvious to the commander that the aircraft is not in a dangerous situation with regard to terrain, aircraft configuration or the present manoeuvre of the aircraft.

ENHANCED GROUND PROXIMITY WARNING SYSTEM (EGPWS)

TERRAIN AWARENESS SYSTEM (TAWS)

EGPWS does not “look ahead” and any **Mode 2 warning** when flight is towards high ground will be **dependent upon the steepness of the terrain. Hence, a sheer cliff ahead will not generate a mode 2 warning** and any subsequent warning due to rising ground beyond the cliff will be delayed until the aircraft is over that ground. However this limitation has been overcome by **Enhanced GPWS** with the **Terrain Threat Display**. This uses essentially an electronic map of the world (giving ground elevation) and information from the aircraft’s navigational system (be that INS/GPS or any combination). Given the location of the aircraft, its course and height (either from the ADC or derived from GPS) a display can be created showing the locations of terrain that could threaten the safety of the aircraft.

Using this system EGPWS can warn of approaching high terrain even when that terrain is not in close enough proximity to initiate a mode 2 warning. This terrain threat display and warning will be initiated in sufficient time to comfortably avoid any threat of flight into terrain. The terrain is shown in shades of green, yellow and red and the display indicates terrain not only below the aircraft but also ahead of its flight path. At a certain time before predicted impact the warning will issue a “**Caution Terrain**” message and the threat terrain will turn solid yellow. If the situation is allowed to deteriorate so as to close further with the high ground, the second message “**Whoop Whoop Pull Up**” will sound and the most threatening terrain will turn solid red. This will happen at sufficient spacing to avoid impact with the terrain but this time using more positive control movements.

The accuracy of this display is however linked to the accuracy of the navigational equipment. A poor nav fix or a malfunctioning nav system will result in dangerously inaccurate display. Some pilots have been found to be using the threat display to “thread” their way through high terrain. This is of course a gross misuse of the system and is strongly advised against.

The terrain display can be **selected by the pilot, or may be automatically activated** whenever the terrain becomes a threat. The threat display may be incorporated with the weather radar display; the navigational display or it may have its own Plan Position Indicator (PPI).

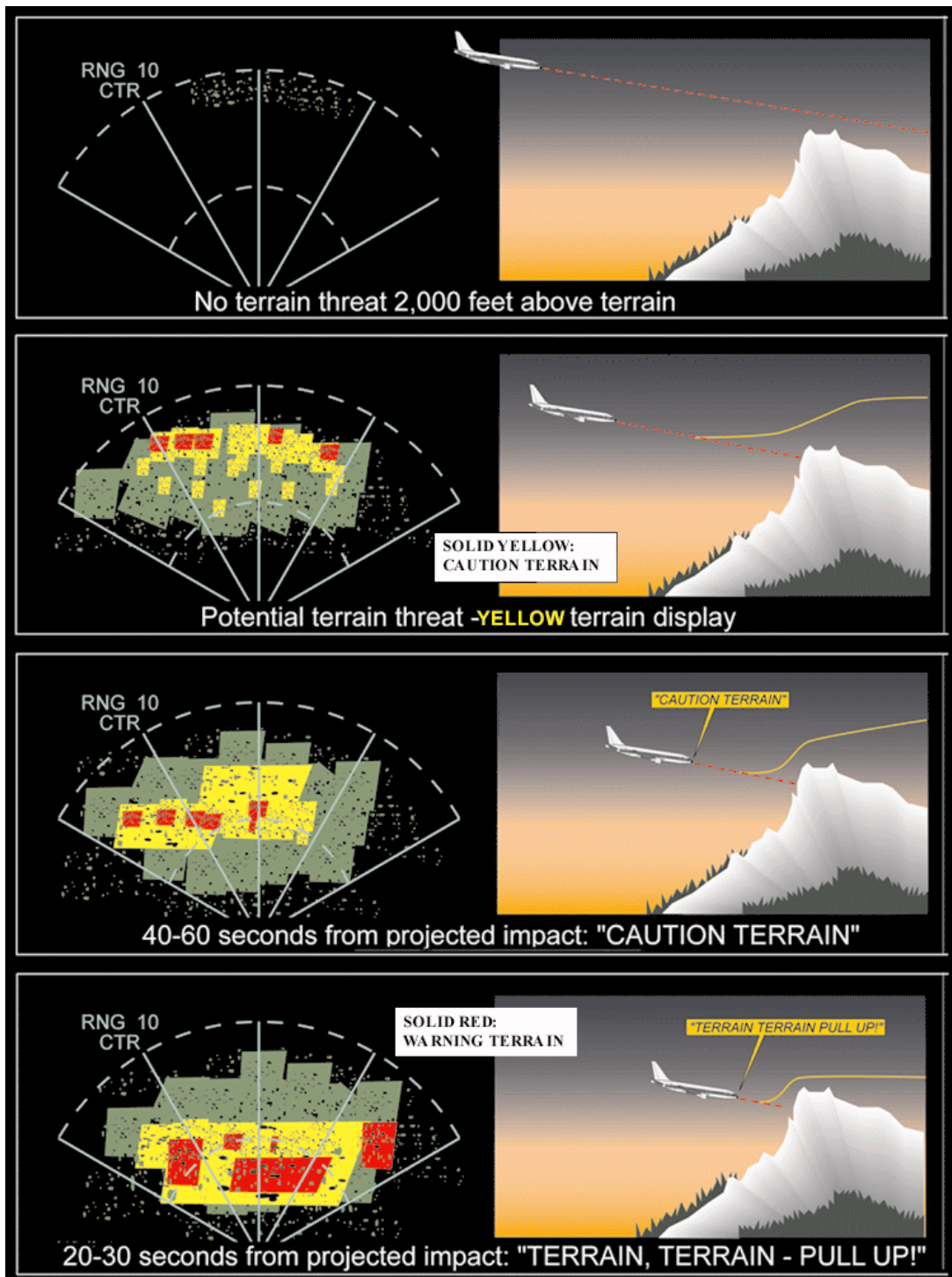

Figure 35.12 Terrain Display

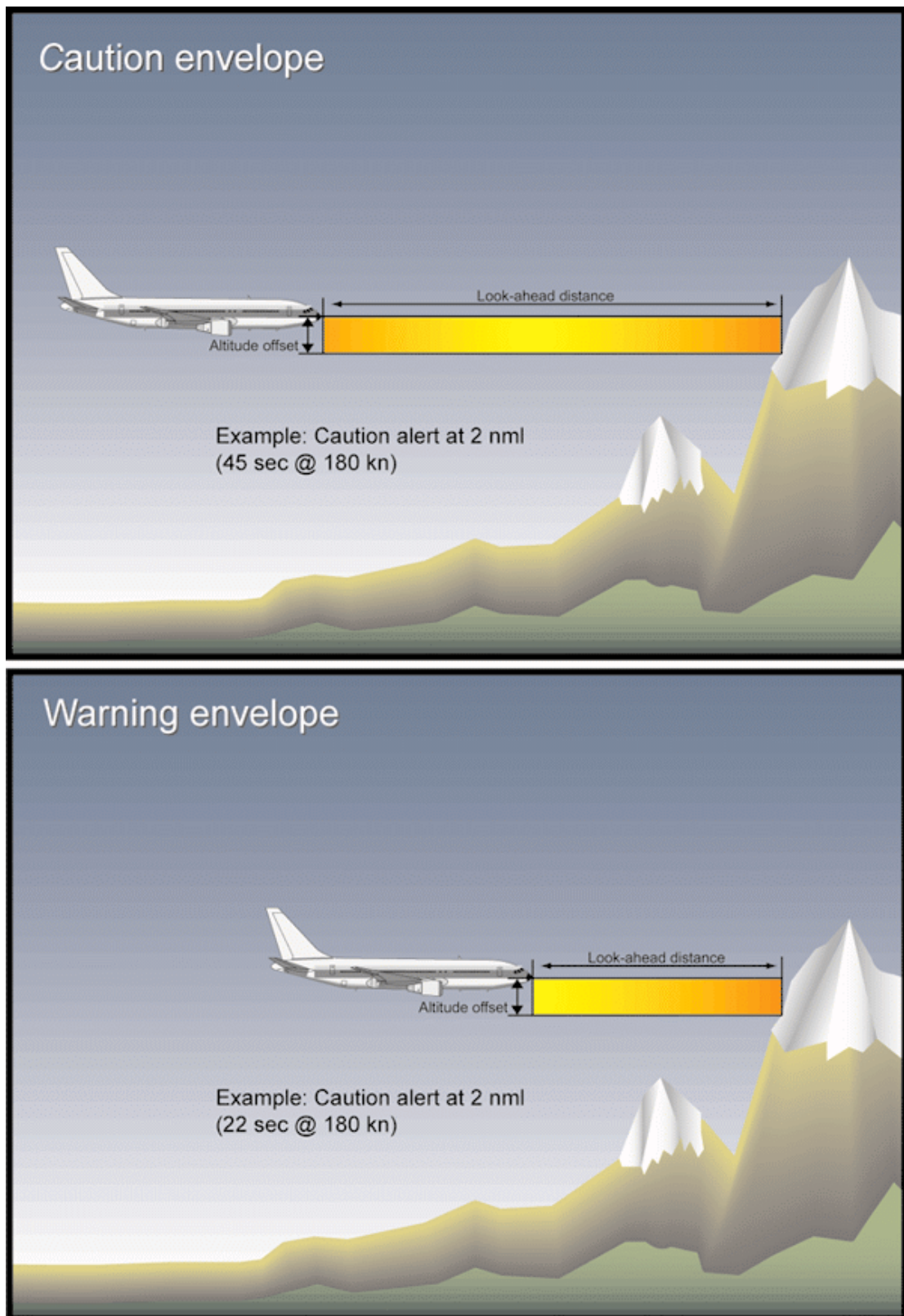

Figure 35.13 "Look Ahead" Warning

TERRAIN CLEARANCE FLOOR

This alerts the crew to possible premature descent for non-precision approaches regardless of aircraft configuration. It uses the present aircraft position with respect to the runway. It is speculated that in the future the database for this and the EGPWS as a whole will be merged with that for the FMS. This will mean that the EGPWS can work with the latest information and include temporary obstacles normally notified by NOTAM.

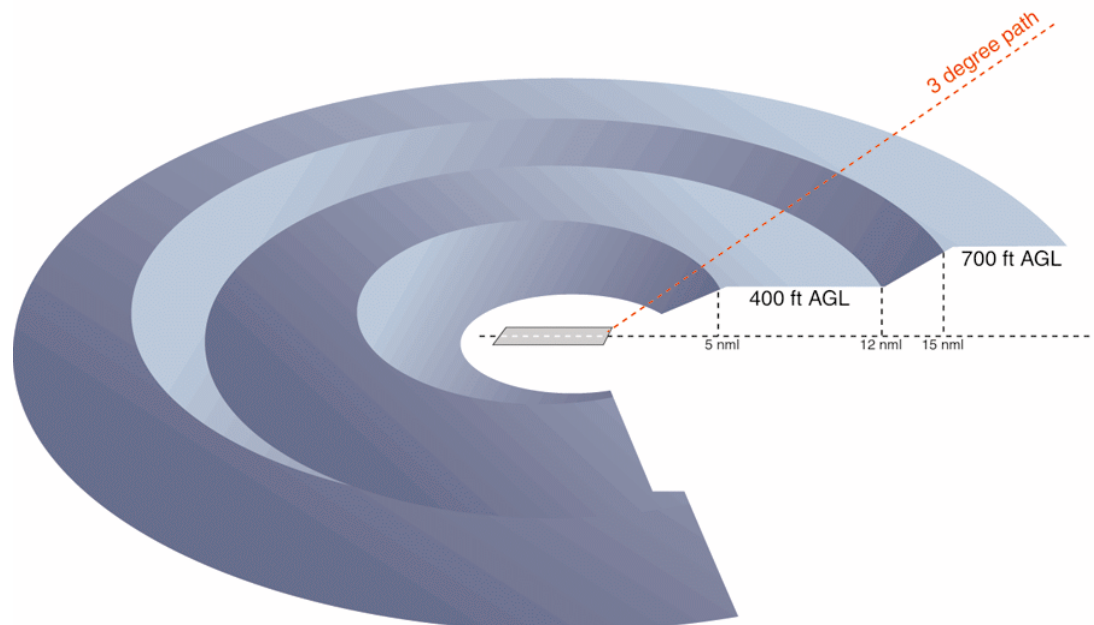

Figure 35.14 Terrain Clearance Floor

INTEGRITY TESTING

The GPWS is provided with **built-in test equipment (BITE)** which allows **all** its functions and visual/audible warnings to be **tested prior to flight**; the pre-flight BITE is **inhibited in flight**. The test is initiated by the pilot pressing the test switch.

During flight the system is continuously monitored to confirm its serviceability and any in-flight failure is automatically indicated on the flight-deck. **A short confidence check is possible while airborne**, but this is not a full BITE check..

INHIBITION OF EGPWS MODES

The EGPWS **must not be de-activated** (by pulling the circuit breaker) except for approved procedures. Instructions on inhibition must include a statement that no person may de-activate the EGPWS except in accordance with the procedures stated in the Operations Manual.

- **Inhibition of the glideslope** mode may be desirable when a glideslope signal is present but the aircraft is deliberately being flown without reference to it, e.g. the pilot may have discontinued the ILS, to land on a different runway, or is performing a localiser only approach.
- Inhibition may also be required when the **gear or flap position** inputs are known to be non-standard.

QUESTIONS

1. The GPWS the alert/warning information is provided by a radio altimeter with:
 - a. a downward transmitting beam whose dimensions are in the order of 60 and 30 in the fore/aft and the athwartship axes.
 - b. a downward transmitting beam whose dimensions are in the order of 30 and 60 in the fore/aft and the athwartship axes.
 - c. a forward transmitting beam.
 - d. a downwards transmitting radio beam

2. The GPWS would provide visual and audible warning to a pilot if the aircraft descended:
 - a. to below 500' radio altitude with flaps not in the landing position and speed below Mach.28
 - b. to below 500' radio altitude with flaps not in the landing position and speed below Mach.35
 - c. to below 200' barometric altitude with flap not in the landing position and speed below Mach.28
 - d. to below 200' radio altitude with flap not in the landing position and speed below Mach.28.

3. The Ground Proximity Warning mode 5 provides a visual and audible warning to the pilot if the aircraft:
 - a. descends below 500ft radio altitude with gear retracted.
 - b. is below 1000ft radio altitude and more than 1.3 dots below the ILS glidepath.
 - c. descend below 200ft radio altitude with flaps retracted.
 - d. sinks more than approximately 10% of accumulated altitude.

4. The GPWS uses inputs from:
 - a. the radio altimeter, the ILS receiver, the Air Data Computers and the landing gear position indicators.
 - b. the radio altimeter, the Air Data Computers, the landing gear position indicators and the flap position indicators.
 - c. the radio altimeter, the Air Data Computers, the Captain's ILS receiver, the landing gear position indicators and the flap position indicators.
 - d. the radio altimeter and the ILS receiver.

5. The Ground Proximity Warning mode 4a provides a visual and audible warning 'Too Low Gear' to the pilot if the aircraft descends below _____ with landing gear retracted.
 - a. 200 feet radio altitude with speed below M 0.28.
 - b. 200 feet barometric altitude with speed below M 0.28.
 - c. 500 feet radio altitude with speed below M 0.35.
 - d. 500 feet barometric altitude with speed below M 0.35.

6. An aircraft 'goes around' after descending to a radio alt of 190 feet. As power is applied a power unit is lost and some height is lost. The GPWS would provide an alert when the aircraft had lost about:
 - a. 10 feet
 - b. 20 feet
 - c. 50 feet
 - d. 100 feet

 7. GPWS Mode One gives warning of:
 - a. excessive descent rate.
 - b. height loss after take-off/missed approach.
 - c. unsafe terrain clearance when not in the landing configuration.
 - d. excessive terrain closure rate.

 8. GPWS, Mode Three gives warning of:
 - a. excessive descent rate.
 - b. height loss after take-off/missed approach.
 - c. unsafe terrain clearance when not in the landing configuration.
 - d. excessive terrain closure rate.

 9. GPWS, mode two operates between:
 - a. 50ft and 2450ft agl
 - b. 50ft and 1800ft agl
 - c. 50ft and 700ft agl
 - d. 50ft and 500ft agl

 10. With reference to GPWS:
 - a. In all six modes the audible alerts and warnings are accompanied by the red flashing PULL-UP' light.
 - b. Mode 4A activates when the aircraft descends below 500ft radio altitude at a speed less than .35Mach with the landing gear retracted.
 - c. Mode 4A activates when the aircraft descends below 500ft barometric altitude at a speed less than .28Mach with the landing gear retracted.
 - d. Mode 6 re-arms when the aircraft leaves the hard alerting area.

 11. An aircraft 'goes around' after descending to a radio altitude of 190ft. As power is applied a power unit fails and some height is lost. The GPWS would provide an alert when the aircraft had lost about:
 - a. 10ft
 - b. 20ft
 - c. 50ft
 - d. 100ft

 12. GPWS mode 3 will operate if altitude loss occurred before you have acquired:
 - a. 700 ft barometric altitude gain.
 - b. 500 ft terrain clearance.
 - c. 200 ft barometric altitude gain.
 - d. 700 ft terrain clearance.
-

13. With reference to GPWS Mode 4. At or below what radio altimeter altitude is mode 4 activated if not in the landing configuration?
 - a. 500 ft
 - b. 700 ft
 - c. 200 ft
 - d. 790 ft

14. Mode 4 gives warning of:
 - a. excessive descent rate.
 - b. height loss after take-off/missed approach.
 - c. unsafe terrain clearance when not in the landing configuration.
 - d. excessive terrain closure rate.

ANSWERS

- 1 B
- 2 D
- 3 B
- 4 C
- 5 C
- 6 B
- 7 A
- 8 B
- 9 A
- 10 B
- 11 B
- 12 D
- 13 B
- 14 C

CHAPTER THIRTY SIX

AIRBORNE COLLISION AND AVOIDANCE SYSTEM (ACAS)

Contents

INTRODUCTION 511

TCAS I 511

TCAS II 511

PRINCIPLE 511

AIRCRAFT EQUIPMENT 512

OPERATION 512

SYSTEM INTERCONNECTIONS 513

SYNTHETIC VOICE PRIORITISATION 514

TRAFFIC ADVISORIES (TAs) RESOLUTION ADVISORIES (RAs) 515

RESOLUTION ADVISORIES 515

PROXIMATE TRAFFIC/OTHER TRAFFIC 516

DATA TAG 517

OFF SCALE TRAFFIC ADVISORY 517

TCAS DISPLAYS 517

COMBINED TCAS AND SSR CONTROL PANEL 519

TCAS TRAFFIC ADVISORIES ON ELECTRONIC VSI 520

TCAS PREVENTATIVE RESOLUTION ADVISORIES ON ELECTRONIC VSI 520

TCAS CORRECTIVE RESOLUTION ADVISORY ON ELECTRONIC VSI 521

TCAS TEST FORMAT ON ELECTRONIC VSI 521

NO BEARING ADVISORIES 522

ACTION TO BE TAKEN ON RECEIVING TA's AND RA's 522

STANDARD R/T PHRASEOLOGY 523

QUESTIONS 525

ANSWERS 526

INTRODUCTION

Today's higher traffic densities and greater speed differences have generated a need for an Airborne Collision Avoidance System. Although ICAO named it ACAS it is usually known as **Traffic Alert and Collision Avoidance System (TCAS)**. The system is designed to provide an additional margin of safety and keep commercial aircraft **clear of conflict**, independently of Air Traffic Control. An aircraft must carry a transponder and have the facility to interrogate other aircraft transponders. Of the four proposed systems, TCAS I, II, III and IV, TCAS I and II fulfill present and future requirements. Aircraft built to carry more than 30 passengers must have an approved system for flight in the USA.

TCAS I

TCAS I is a first generation collision avoidance system and simply warns the crew of other traffic in the vicinity of their aircraft. It will detect and display range and approximate relative bearing. If the TCAS display aircraft and the intruder are carrying Mode C relative altitude will also be displayed. It encourages flight crew to look for the conflicting traffic by generating visual and aural warnings - **TRAFFIC ADVISORIES (TAs)**:

"Traffic, Traffic".

It **does not give any resolution advisory** information. i.e. a course of action to follow. **The FAA requires smaller aircraft, with 30 or fewer seats, to carry TCAS I.**

TCAS II

TCAS II detects intruders in the TCAS aircraft's vicinity, assesses the collision risk and presents warnings to the crew in the form of **TAs** and **Resolution Advisories (RAs)** e.g.:

"Climb" "Increase Climb" Descend" "Increase Descent" Monitor Vertical Speed"

Thus, RAs offer manoeuvring advice **in the vertical plane** to resolve conflict. If the your aircraft and the intruder both have Mode S data-link transponders the system will co-ordinate the RAs to provide complimentary vertical avoidance instructions. The rest of this chapter deals with TCAS II only and discusses both visual and audible TAs and RAs in detail.

PRINCIPLE

TCAS II operates on the secondary radar principle using the normal SSR frequencies of 1030MHz and 1090MHz, but in an air to air role. Using this principle the TCAS system creates two protective three dimensional bubbles around the TCAS equipped aircraft (Figure 36.1.)

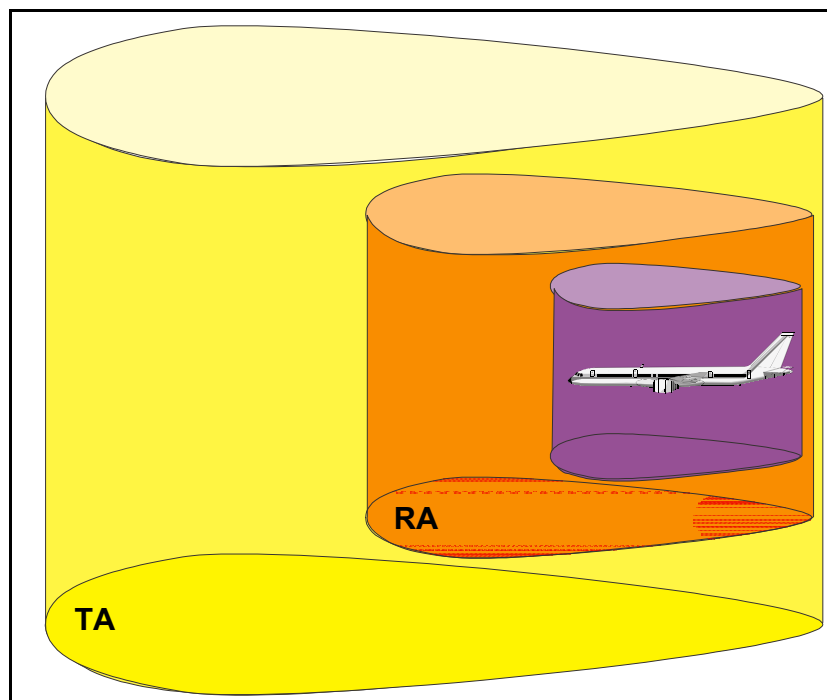

Figure 36.1

AIRCRAFT EQUIPMENT

For aircraft to be visible to a TCAS equipped aircraft they must have a minimum of A **Mode "A" Transponder**. If the transponder is switched off, or is unserviceable, the intruding aircraft are invisible to the TCAS equipment and a collision risk exists. **Mode A transponders transmit no height information and therefore the information available to the TCAS equipment is two dimensional only** and therefore can only give TAs.

Mode "C" Transponder equipped intruders broadcast height information to the TCAS equipment and the system becomes **three dimensional** and can now give both TAs and RAs. **Mode "S" Transponder** TCAS equipped intruders as well as broadcasting height information allow a discrete data link to be established between them. This data link will allow avoidance manoeuvres to be mutually resolved.

OPERATION

The **range** of an intruder is determined by measuring the time lapse between transmission of an interrogation and receiving the response. (Radar Principle). The **bearing** of an intruder is determined by a directional antenna (Figure 36.2.). Because of the wavelengths involved and the necessarily small size of the antennas **bearing resolution is the least accurate parameter**. TCAS never offers collision avoidance commands in the horizontal plane; only in the form of climb or descend. .

The **relative height** of an intruder is found by comparing it's Mode "C" height with the TCAS equipped aircraft's height.

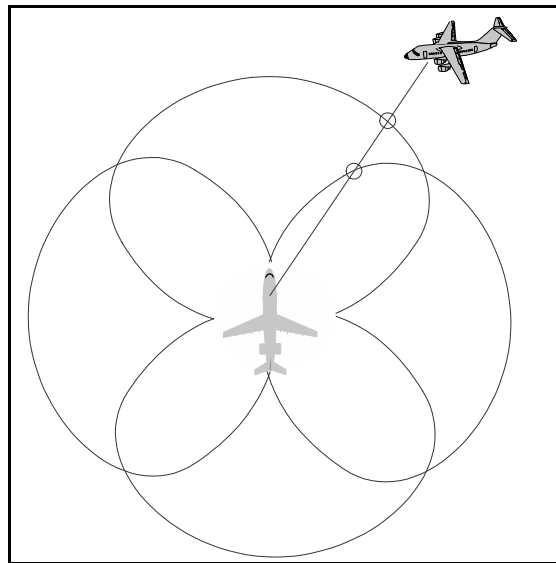

Figure 36.2 TCAS Bearing Determination

SYSTEM INTERCONNECTIONS

Figure 36.3 shows a TCAS installation in a Commuter/Feeder airliner. The heart of the system is the TCAS receiver-transmitter-computer unit controlled by a combined ATC/SSR/TCAS control panel. The TCAS displays in this installation are a dedicated TCAS Plan Position Indicator (PPI), and the red and green sectors on the Vertical Speed Tape of the Primary Flight Display (PFD). Electronic Attitude Director Indicator (EADI). A synthetic voice issues TCAS commands over the intercom system.

The TCAS upper and lower antennas are directional while the Mode "S" antennas are omnidirectional.

The TCAS also has feeds from the Radio Altimeter to modify the RAs received when in close proximity to the ground i.e. there are no instructions given at all when the aircraft is below 400ft agl, no descent RAs are given below 1000ft agl and no increase rate of descent commands below 1400ft agl. The system will also take aircraft configuration / performance into consideration when deciding an avoiding action. When the aircraft has gear and / or flap deployed its climb performance will be poor so TCAS will avoid giving climbing demands for a RA.

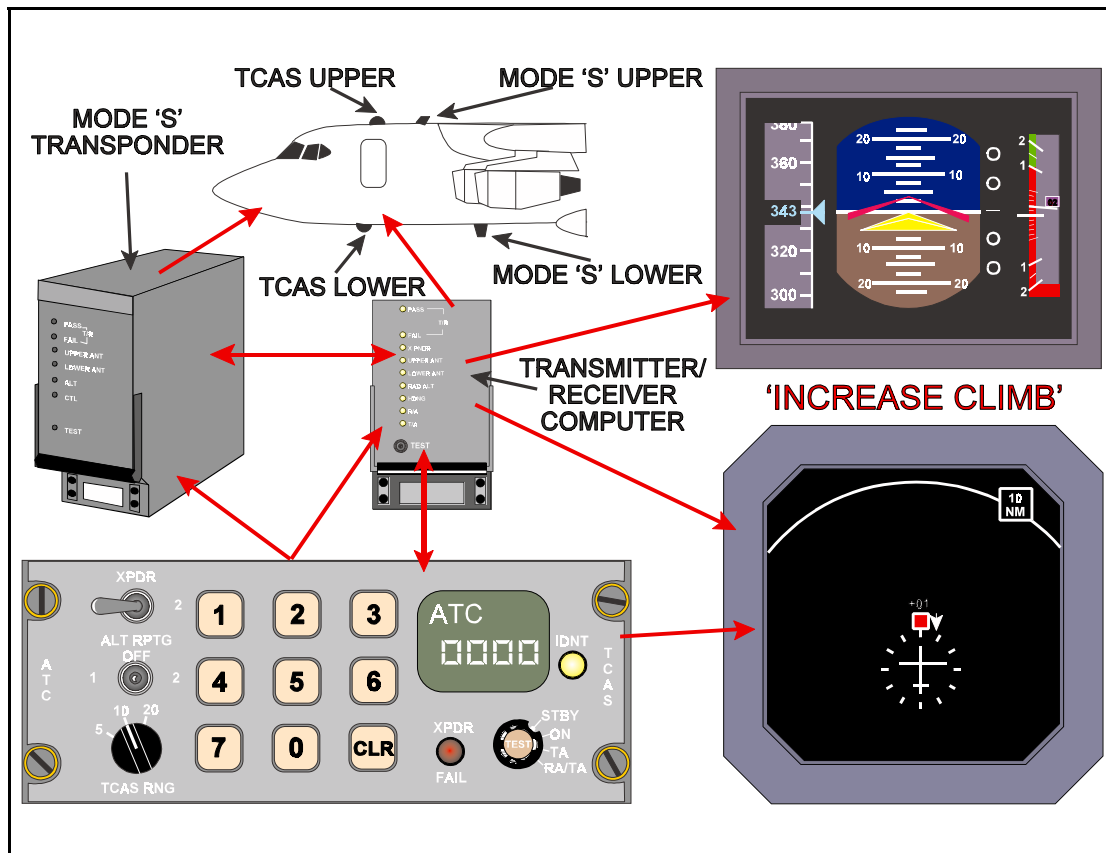

Figure 36.3 TCAS Aircraft Installation

SYNTHETIC VOICE PRIORITISATION

Modern aircraft use a synthetic voice to give warning advice to the crew. The voice is used for various systems including Windshear detection, Ground Proximity Warnings, including height call outs, and TCAS. The synthetic voice is prioritised as follows:

Stall Identification/Stall Prevention. (Stick Shake/Stick Push). The synthetic voice is inhibited during stick shake/stick push operation.

Windshear. The detection of performance decreasing windshear takes first priority with the synthetic voice, inhibiting both GPWS and TCAS warnings.

Ground Proximity Warning System(GPWS). Detection of approach to terrain takes priority over TCAS announcements.

TRAFFIC ADVISORIES (TAs) RESOLUTION ADVISORIES (RAs)

Depending upon the setting of the TCAS function switch on the control panel, the equipment level of intruder aircraft and the phase of flight of the TCAS aircraft, TCAS will generate the following.

- a) **Traffic Advisories (TAs)** exist when an intruder penetrates the outer bubble caution area and is between 45 and 35 seconds from the collision area. TA's appear as **solid amber circles** on the TCAS display and are accompanied by the synthetic voice saying "**Traffic, Traffic**". This is a potential collision threat.
- b) **Resolution Advisories (RAs)** exist when an intruder penetrates the inner bubble warning area and is between 30 and 20 seconds from the collision area. RA's appear as **solid red rectangles** on the TCAS display accompanied by various synthetic voice warnings. RA's indicate a serious collision threat. (See Figure 36.4.)

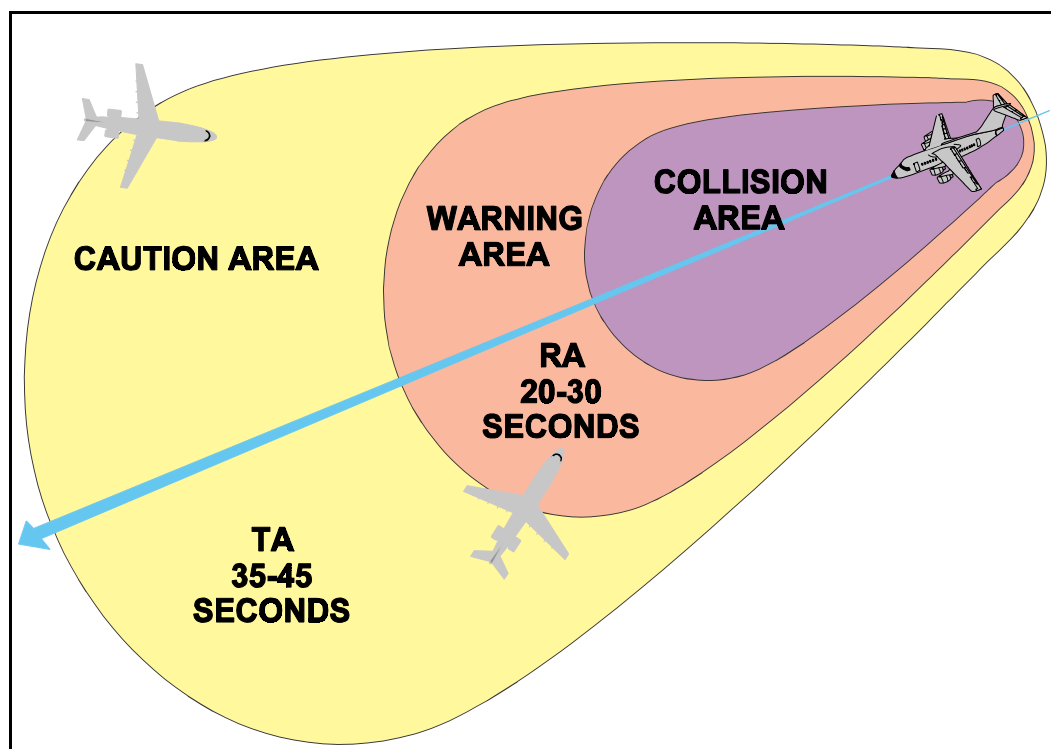

Figure 36.4

RESOLUTION ADVISORIES

Resolution Advisories come in two forms:

Preventative Advisories are situations where no collision risk exists unless a change of level is initiated by either aircraft. The synthetic voice advisory is "**Monitor Vertical Speed**"

Corrective Advisories are situations where a collision risk exists and a manoeuvre is necessary to avert it. The synthetic voice produces the appropriate command.

Figure 36.5. shows examples of Preventative and Corrective RA's displayed on the Vertical Speed tape of the Primary Flight Display.

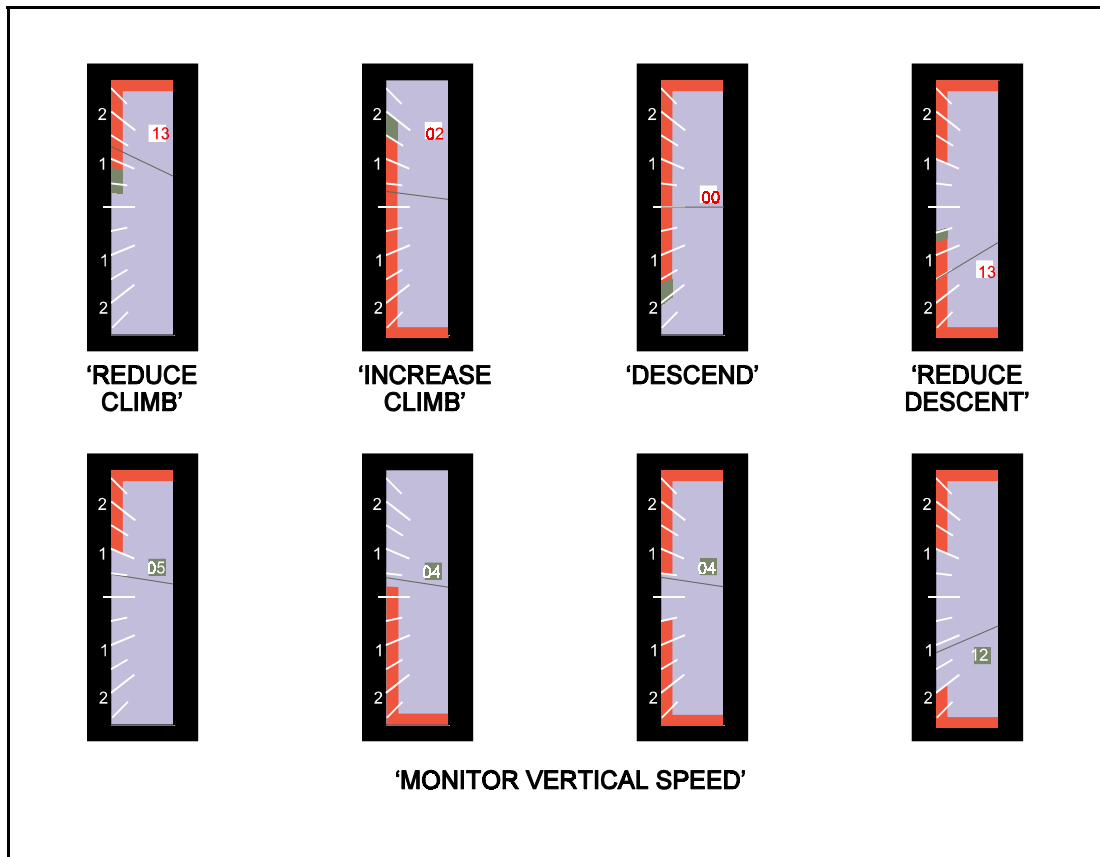
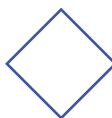

Figure 36.5 Corrective and Preventative Resolution Advisories.

PROXIMATE TRAFFIC/OTHER TRAFFIC



Proximate Traffic appears as a solid cyan diamond and represents transponder equipped aircraft within range of the display and within +/- 1200 feet relative height. TCAS does not consider this traffic a threat and displays it to improve crew situational awareness.



Other Traffic appears as hollow cyan diamonds which represent transponder equipped aircraft within range of the display and within +/- 2700 feet relative height (+/- 8700 dependant on position of ABOVE and BELOW switch). Again it is displayed to improve situational awareness.

The predicted flight paths of Proximate and Other Traffic do not penetrate the Collision Area of the TCAS aircraft.

DATA TAG

The traffic symbols may also have an associated altitude TAG which shows relative altitude in hundreds of feet, to indicate whether an intruder is climbing, flying level or descending:

A **+ sign** and number above the symbol means an **intruder is above** the aircraft.

A **trend arrow** ↑ or ↓ appears alongside the symbol when the intruder's vertical rate is **500 feet per minute or greater**.

No altitude number or trend arrow will appear beside an intruder that is non altitude reporting. If TCAS II direction finding techniques fail to locate the azimuth of another aircraft a **no bearing** message appears on the screen.

OFF SCALE TRAFFIC ADVISORY

When TCAS is tracking an intruder that is outside the selected display range, but has entered the caution or warning areas, one-half of the appropriate symbol will appear at the appropriate bearing at the edge of the display area. The symbol will appear in its proper colour and have its data tag displayed providing there is room. See Figure 36.10.

TCAS DISPLAYS

TCAS range and bearing information can appear on a variety of displays:

Dedicated Plan Position Indicator.

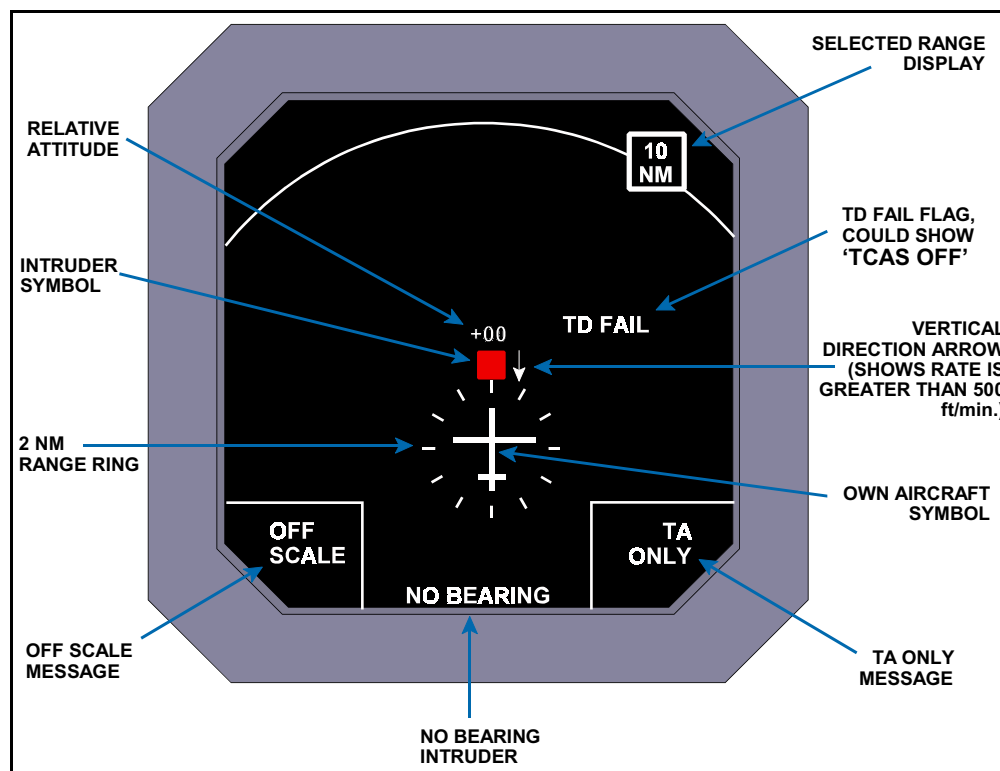

Figure 36.6 TCAS PPI.

Electronic Vertical Speed Indicator

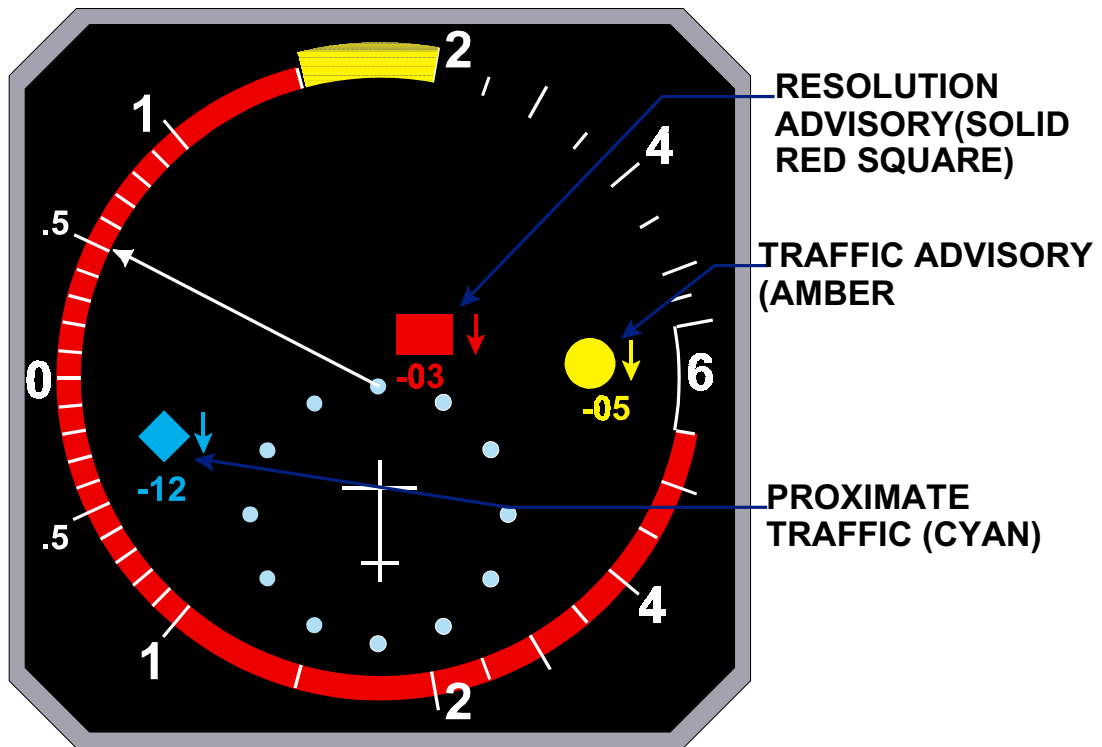

Figure 36.7 Electronic VSI

Superimposed on Navigation Display of EFIS equipped aircraft.

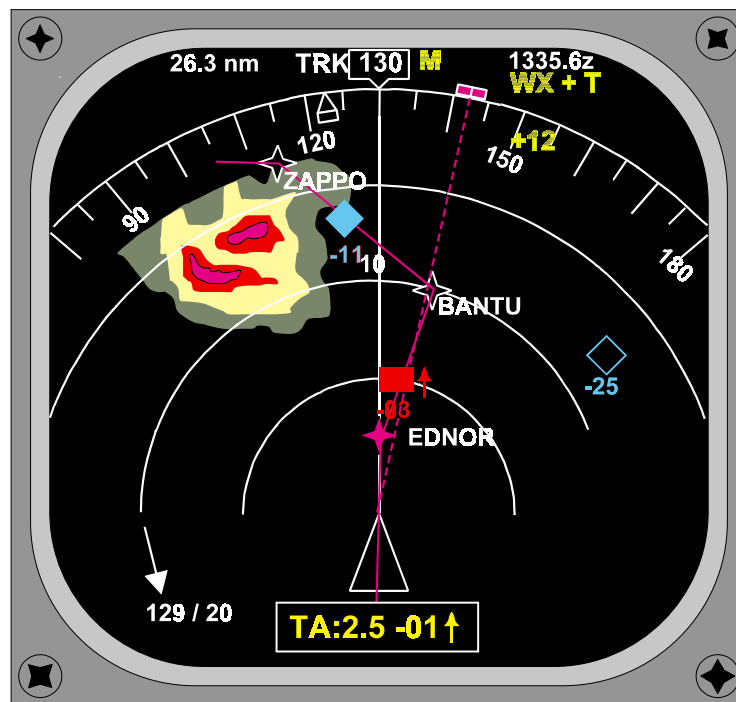

Figure 36.7a Navigation Display in MAP Mode Showing TCAS

COMBINED TCAS AND SSR CONTROL PANEL

The control panel is produced in various forms but all perform the same functions. The TCAS controls are as follows: See Figure 36.8.

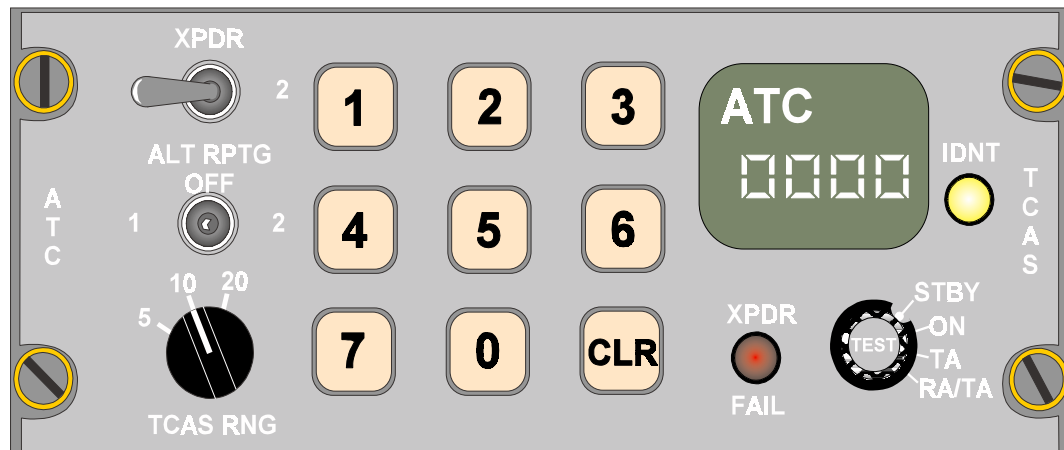

Figure 36.8 ATC Transponder/TCAS Control Panel

Function Switch

- Standby - warm-up power is applied to the system, but it is not operational.
- On - the transponder only is operational.
- TA - the transponder and TCAS are now operational but only Traffic Advisories are generated. "TA ONLY" will be indicated on the TCAS display.
- RA/TA - the transponder and TCAS are operational and both Resolution Advisories and Traffic Advisories are generated.
- TEST - pressing the centre TEST button on the function switch initiates a full Built - in - Test Equipment (BITE) of the system. After completion of a successful test the synthetic voice will respond with "TCAS SYSTEM TEST OK". If the system test is unsuccessful the voice response is "TCAS SYSTEM TEST FAIL".

TCAS RNG (range)

This will select the range of the TCAS display either 5, 10, or 20nm. It does not alter the range at which aircraft are detected or when warnings are given.

TCAS TRAFFIC ADVISORIES ON ELECTRONIC VSI

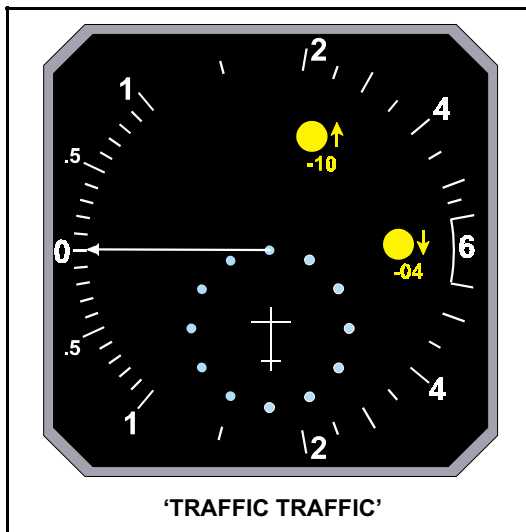

Figure 36.9 Traffic Advisory

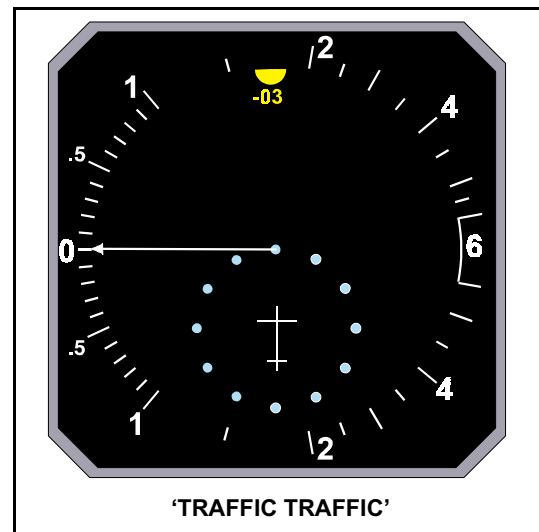

Figure 36.10 Off Scale Traffic Advisory

TCAS PREVENTATIVE RESOLUTION ADVISORIES ON ELECTRONIC VSI

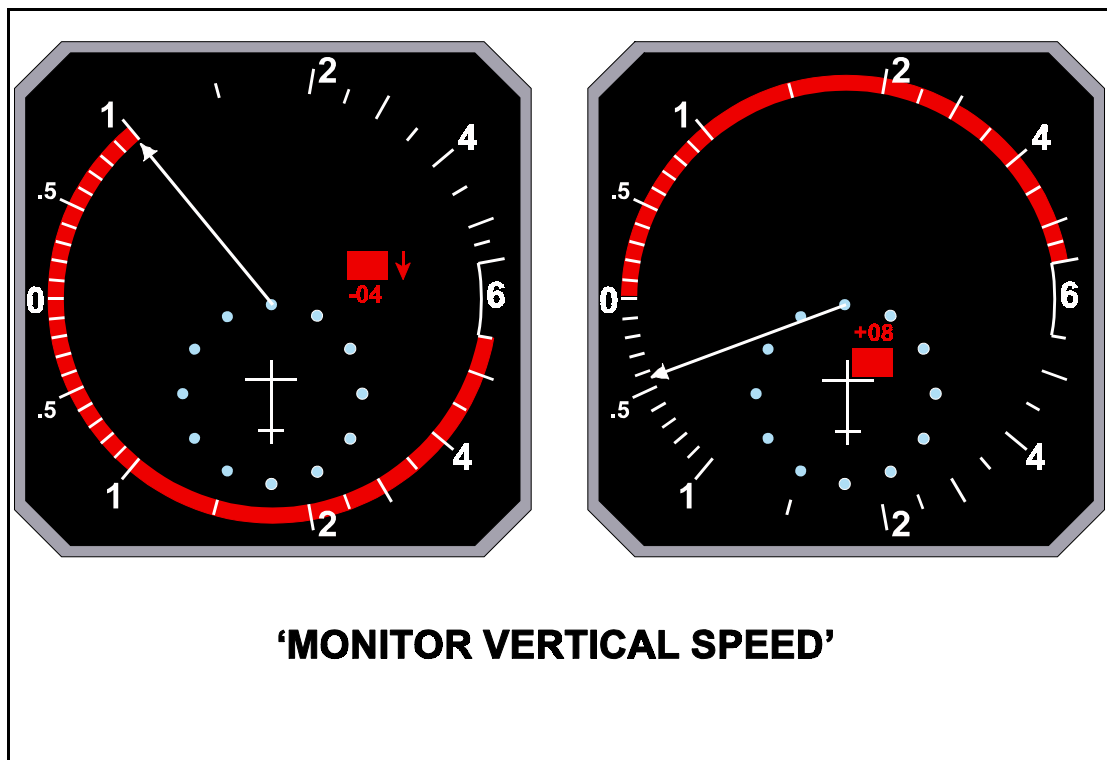

Figure 36.11 Preventative Resolution Advisories

TCAS CORRECTIVE RESOLUTION ADVISORY ON ELECTRONIC VSI



Figure 36.12 Corrective RA

TCAS TEST FORMAT ON ELECTRONIC VSI

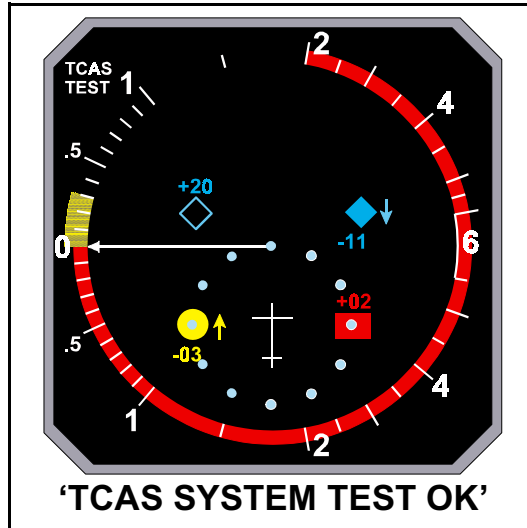

Figure 36.13 Test Display

NO BEARING ADVISORIES

If TCAS is unable to track the bearing of an intruder, possibly due to antenna screening, the RA or TA will appear lower centre of the display appropriately colour coded. Up to two lines of information can be displayed.

“TA 2.2- 04” means the intruder is creating a TA 2.2 nm away 400 below and the up arrow indicates the intruder is climbing at 500 fpm or greater.

It is important to realise that TCAS’ ability to compute a Traffic or Resolution Advisory is not degraded by lack of bearing information.



Figure 36.14 No Bearing RA and TA

ACTION TO BE TAKEN ON RECEIVING TA's AND RA's

Refer to CAP 579

- **Action on Receiving a TA.** TAs alert flight crews to the possibility that an RA may follow, which could require a flight path change. Flight crews should assimilate the information provided by the TA and commence a visual search of that part of the sky. They should also prepare to respond to an RA if the situation worsens. If the potential threat cannot be seen and continues to give cause for concern flight crews should seek advice from ATC. (Para. 6.1.1/2.).
- **Action on Receiving an RA.** Pilots are to initiate the required manoeuvre immediately, adjusting flight path, aircraft power and trim accordingly. Crew members not involved in executing this manoeuvre should confirm that the sky ahead is clear of other aircraft and continue the visual search for the established threat. They are to inform ATC as soon as possible of any deviation from an ATC clearance. (Para. 6.2.3.)
- **Disregarding RA's.** Manoeuvres should never be made in a direction opposite to that given in an RA; this is because the sense may have been determined following an exchange of data with the established threat. For this reason:
 - RA's may be disregarded only when pilots visually identify the potentially conflicting traffic and decide no deviation from the current flight path is needed. (Para 6.2.4.(a. refers)
 - If pilots receive simultaneously an instruction to manoeuvre from ATC and an RA, and both conflict, the advice given by TCAS should be followed.
 -

STANDARD R/T PHRASEOLOGY

Notification of a manoeuvre in response to an RA.

Pilot: TCAS climb (or TCAS descent).

Controller: roger.

after "clear of conflict".

Pilot: Returning to xxxft/flxx (details of assigned clearance).

Controller: roger, a revised clearance may then be issued.

inability to comply with atc instruction.

Controller: climb (descend. flxx).

Pilot: Unable to comply, TCAS RA..

Further reading: CAP 579 airborne collision avoidance systems (ACAS): guidance material.

QUESTIONS

1. On receipt of a TCAS RA your action is to:
 - a. initiate the required manoeuvre immediately.
 - b. make a note of the details.
 - c. request a flight clearance deviation from ATC.
 - d. Do nothing until a TA is received.

2. Which of the following statements concerning TCAS is correct:
 - a. TCAS 2 provides avoidance instructions in the vertical and horizontal planes.
 - b. TCAS 2 cannot provide information on non-SSR equipped intruders.
 - c. TCAS 2 requires Mode S to be fitted to other aircraft.
 - d. TCAS 2 provides advice on which way to turn.

3. With reference to Traffic Collision Avoidance Systems. The difference between TCAS I and II is that:
 - a. TCAS II can provide Traffic Advisories and Resolution Advisories whilst TCAS I can only provide Traffic Advisories .
 - b. TCAS II can only be fitted to large aircraft which carry more than 30 passengers. Whilst TCAS I can be fitted to any aircraft.
 - c. TCAS I can be fitted to aircraft which carry transponders with Mode A only whilst TCAS II can only be fitted to aircraft whose transponders include either Mode C or Mode S.
 - d. TCAS II can only be fitted to aircraft which are equipped with EFIS.

4. The aural messages provided by TCAS II are:
 - a. Threat, Climb; Threat, Descend.
 - b. Climb left; Climb right; Descend left; Descend right.
 - c. Climb; Descend; Increase climb; Increase Descent.
 - d. Turn left, Turn Right, Increase Turn, Decrease Turn

5. With reference to Traffic Collision Avoidance Systems:
 - a. RAs may be disregarded only when the pilot visually identifies the potentially conflicting traffic and decides that no deviation is necessary and has the clearance confirmed by ATC.
 - b. RAs may be disregarded only when the pilot visually identifies the potentially conflicting traffic and decides that no deviation is necessary and has advised ATC of the other aircraft's proximity.
 - c. RAs must never be disregarded.
 - d. RAs may be disregarded only when the pilot visually identifies the potentially conflicting traffic and decides that no deviation is necessary.

ANSWERS

- 1 A
- 2 B
- 3 A
- 4 C
- 5 D

CHAPTER THIRTY SEVEN

FLIGHT DATA RECORDER

Contents

INTRODUCTION529
FDR DESIGNS529
FDR COMPONENTS529
AIRCRAFT INTEGRATED DATA SYSTEMS (AIDS)531
PARAMETERS RECORDED532
JAR REQUIREMENTS.533

INTRODUCTION

Commercial aircraft have a flight recorder which records various aircraft parameters during the entire duration of the flight. The main function of the flight data recorder (FDR) is to preserve the aircraft data in order to determine the cause of any aircraft accident. It is also used to gather information for trend analysis and trouble shooting. In smaller aircraft the FDR may be combined with a cockpit voice recorder.

FDR DESIGNS

The FDR records the last 10 or 25 hours of aircraft data on a digital storage device housed in a fire and shock resistant box. The box is painted red or orange and located at the rear of the aircraft, normally under the fin. On the front of the unit is an underwater locating device (ULD). The older type of FDR's are of non digital design while the JAR now states that on aircraft registered as of the 1 April 2000, all FDR's must be of the digital type.

FDR COMPONENTS

The FDR consists of the following components (see Figure 37.1):

- a recording system
- a control unit on the overhead panel
- a control unit on the pedestal

The recording system includes a digital flight data recorder (DFDR), a flight data interface unit (FDIU) and a 3-axis linear accelerator (LA).

The control unit on the overhead panel also controls the cockpit voice recorder (CVR). A spring-loaded switch labelled GND CTL can be selected ON or AUTO as follows:

- ON The CVR and the DFDR are energised and the ON light is lit
- AUTO The CVR and the DFDR are energised:
 - on the ground with one engine running
 - in flight (with engine running or stopped).

The control on the pedestal consists simply of a push button labelled 'EVENT' which sets an event mark on the DFDR recording. This acts as a kind of bookmark to enable the "event" to be found rapidly on the recording at a subsequent analysis.

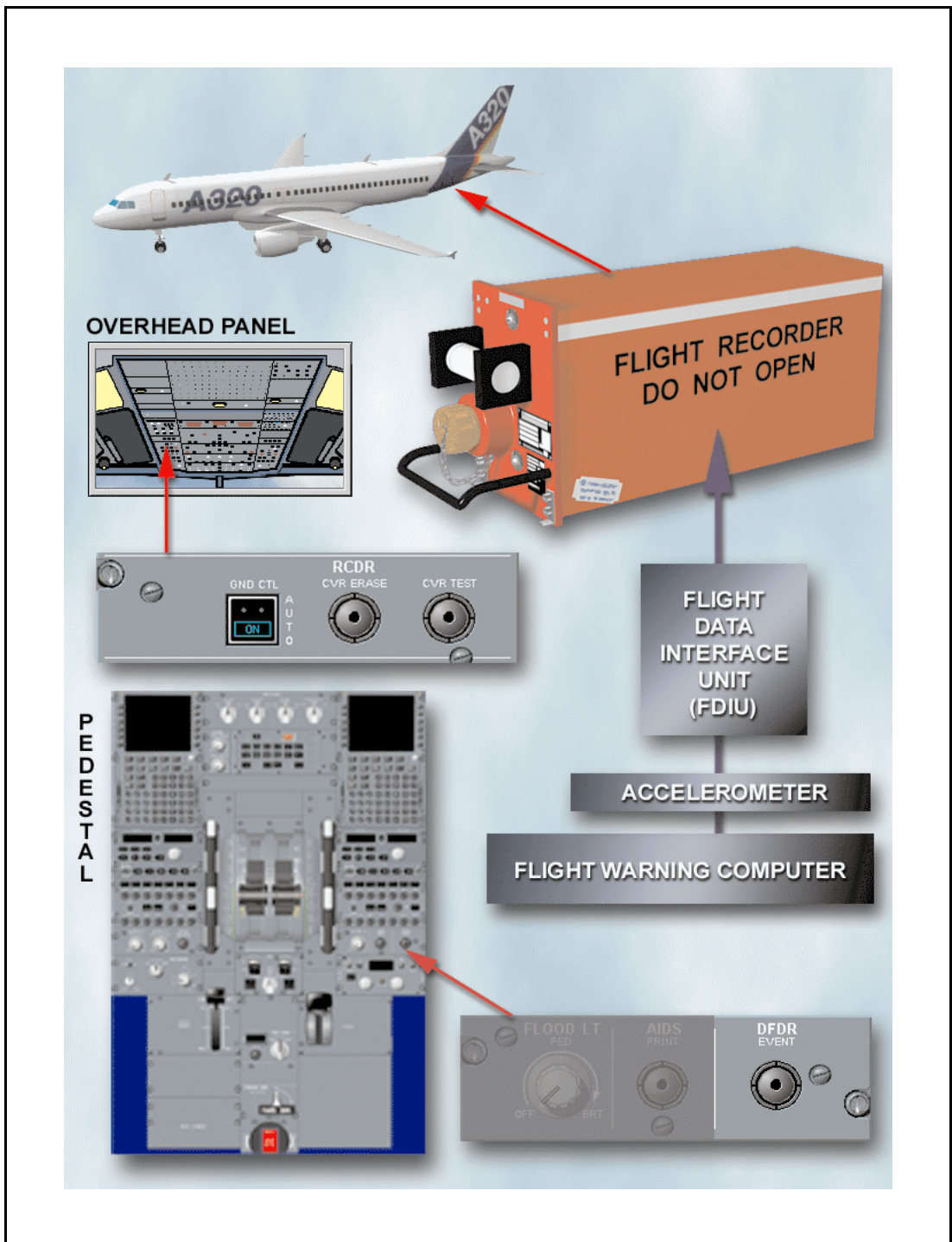

Courtesy of Airbus Industrie

Figure 37.1 Digital Flight Data Recorder

When on the ground the FDR is automatically stopped 5 minutes after the final engine shut-down.

A block diagram of a digital flight data recorder system for a Boeing 767 aircraft is shown in Figure 37.2.

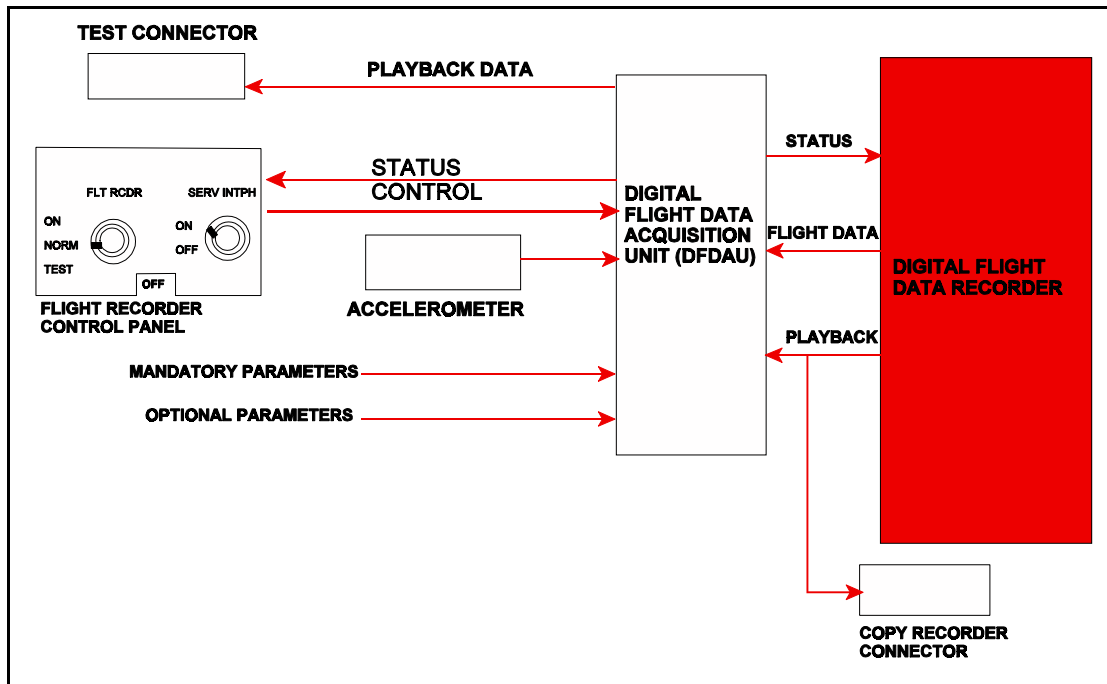

Figure 37.2 Digital Flight Data Recorder System (Boeing)

AIRCRAFT INTEGRATED DATA SYSTEMS (AIDS)

AIDS processes data for various aircraft systems to ease maintenance tasks. This is done via a data management unit (DMU) that collects and processes data to compile reports for storage and for printing. Some of this information is sent to the FDR via the flight data interface unit (FDIU) for recording mandatory parameters of the flight. The rest of the information is recorded on a separate flight maintenance recorder from which data can be printed out for the purpose of maintenance.

Data stored on the DMU can be printed out both in flight as well as on the ground for the purpose of maintenance.

It is also possible to transmit relevant data from AIDS to ground at certain intervals so that the aircraft performance can be monitored from the ground. This is done via ACARS (Airborne Communications and Reporting System) on a VHF data link.

PARAMETERS RECORDED

The mandatory aircraft parameters recorded on the FDR depend upon the age and size of the aircraft and are specified in JAR OPS.

The **main parameters** are:

- altitude
- airspeed
- heading
- acceleration
- pitch and roll attitude
- radio transmission keying
- thrust or power on each engine
- configuration of lift and drag devices
- air temperature
- use of automatic flight control systems and
- angle of attack.

Additional parameters include the following:

- positions of primary flight controls and trim
- radio altitude and navigation information displayed to the flight crew
- cockpit warnings and
- landing gear position.

JAR REQUIREMENTS

Carriage of FDR equipment Period of Recording

It is a requirement of JAR OPS that aircraft shall be equipped with a flight data recorder capable of recording and storing data as follows:

- during at least the last **10 hours** of its operation for an aircraft that is **5700 kg or less** and registered after 1 April 1998
- during at least the last **25 hours** of its operation for an aircraft that is:
 - over 5700 kg or
 - has more than 9 seats

Parameters Recorded

The main parameters mentioned opposite must be recorded in all aircraft weighing 27,000 kg or less while the **additional parameters** must also be recorded in all aircraft **over 27,000 kg**.

Method of Recording

All FDR's must use the digital method of recording except that aircraft registered before 1 April 1995 and weighing more than 5700 kg the continued use of non-digital recorders is acceptable until 1 April 2000.

Other Requirements The other JAR OPS requirements are:

- The FDR must start automatically to record the data prior to the aeroplane being capable of moving under its own steam and must stop automatically after the aeroplane is incapable of moving under its own power.
- The FDR must have a device to assist in locating that recorder in water.
- Aeroplanes of 5700 kg or less may have the FDR combined with the cockpit voice recorder.
- An aeroplane may be dispatched with an inoperative FDR provided that:
 - it is not reasonably practicable to repair or replace the FDR before flight
 - the aeroplane does not exceed 8 further consecutive flights
 - not more than 72 hours have elapsed since the unserviceability
 - any cockpit voice recorder required to be carried is operative (unless it is combined with the FDR)

CHAPTER THIRTY EIGHT
COCKPIT VOICE RECORDER

Contents

INTRODUCTION537
THE RECORDING537
THE VOICE RECORDER537
THE CONTROL UNIT.539
JAR OPS REQUIREMENTS539
QUESTIONS541
ANSWERS542

INTRODUCTION

The principle function of a Cockpit Voice Recorder (CVR) system is to preserve, in the event of an air accident, vital information that is recoverable for use by the Accident Investigation Branch (AIB). The CVR automatically records the last 30 minutes of communications and conversations on the flight deck. It becomes operational whenever 115 volts AC power is applied to the aircraft though it can be disabled during aircraft maintenance. The system comprises a tape recorder, a control unit, a monitor display and an area microphone. The units and their locations are shown in Figure 38.1.

THE RECORDING

The voice recorder is a standard magnetic tape recorder using a minimum of four recording heads and a tape that is about 300 feet long in the form of an endless loop. This should give a minimum 30 minutes of 4-channel parallel recording. The recorder should be capable of recording the frequency range 350 Hz to 3000 Hz though this likely to be increased to 6000 Hz in future. The information recorded includes:

- communications and interphone audio between the captain's, first officer's and the observer's stations via their boom microphones or oxygen mask microphones (these are applied to channels 1,2 and 3).
- conversations and other sounds on the flight deck picked up by a separate area microphone usually mounted on the control unit (applied to channel 4).
- on some two-crew aircraft the observer's channel may be used to record public address messages.

THE VOICE RECORDER

The tape recorder is located inside a crash-proof metal box that is painted red or orange and normally placed at the rear of the aircraft, often adjacent to the flight data recorder. The high impact case should be able to withstand shock, high temperature and fire.

On the front of the unit is fitted an underwater locating device (ULD), that will emit a continuous series of ultrasonic pulses to help locate a submerged CVR. The unit is automatically activated by water and the battery will last several days.

The front panel of the CVR also enables the information recorded on all the tracks to be monitored via a playback head and monitor amplifier.

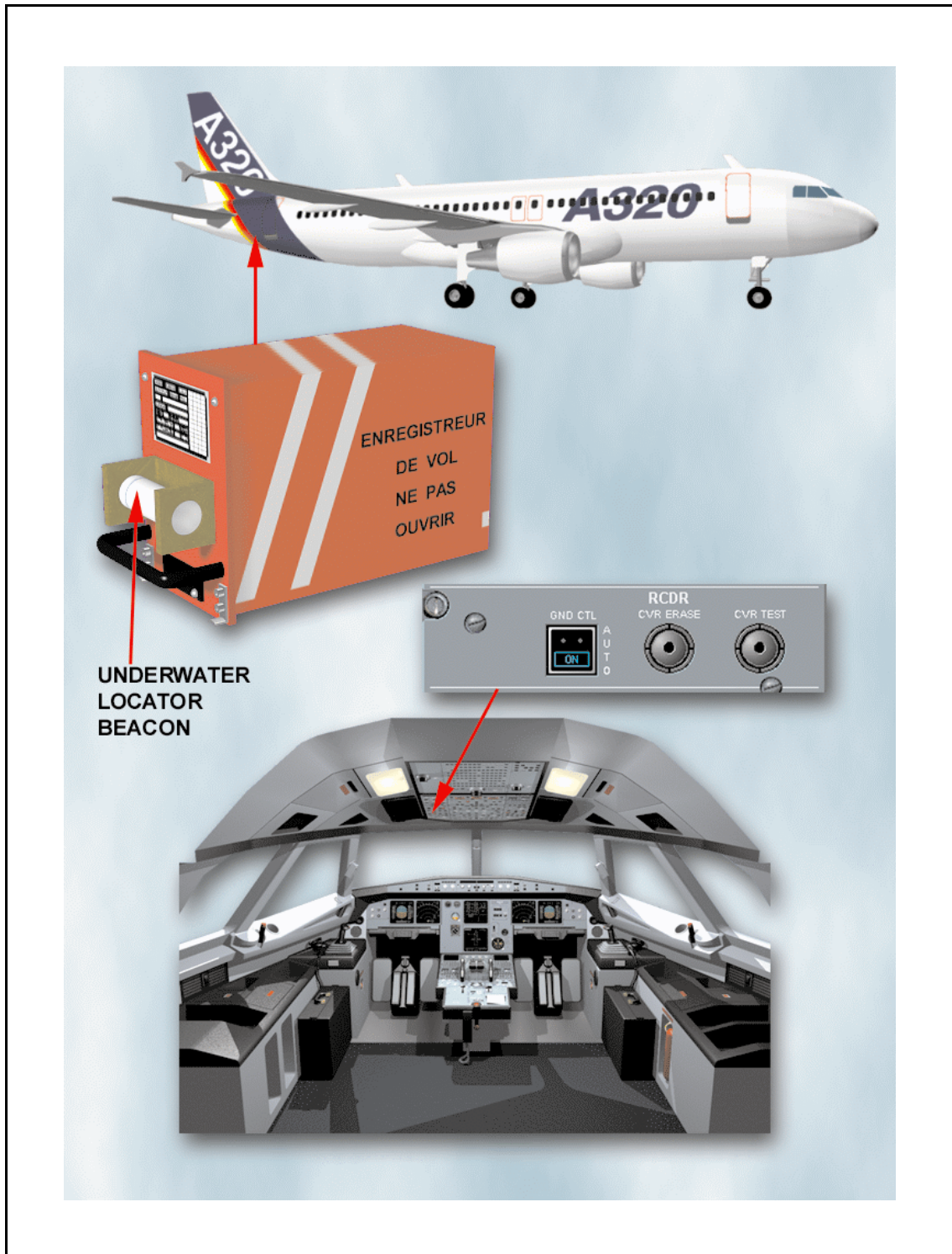

Courtesy of Airbus Industrie

Figure 38.1 Cockpit Voice Recorder

THE CONTROL UNIT

This is mounted on the flight deck, usually in the roof panel. It contains monitoring and testing circuitry and also the area microphone to pick up general flight deck conversations and sounds. It has the following controls:

AUTO / ON When the switch is in the AUTO position the CVR will start to record when the first engine is started and will stop 5 mins after the last engine is shutdown. Selection of the ON position starts the CVR recording immediately and latches the switch in the ON position until first engine start, when it will click back to AUTO.

CVR TEST Pressing the TEST button activates an extensive set of functional tests which determine the integrity of the system using the BITE (built in test equipment) facility. A successful self-test results in a visual 'good' indication (a status deflection needle or a status LED, and a 600 or 800 Hz audio tone heard via the microphone monitor jack.

ERASE Erasure of the tapes is only possible with the aircraft on the ground, all engines stopped and the parking brake set. Suitable safety interlocks are installed to prevent inadvertent or airborne tape erasure. Additionally the erase button must be held depressed for at least 2 seconds before the circuit activates.

Some CVR control units will incorporate the area microphone as shown in Figure 38.2.

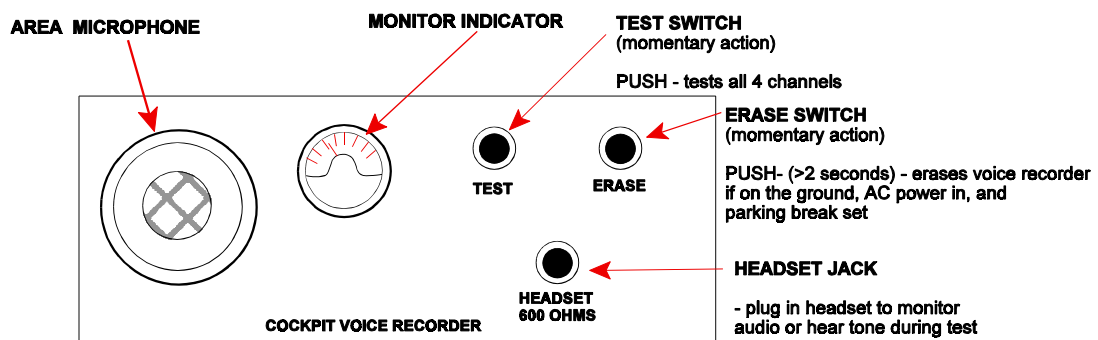

Figure 38.2 CVR Control Unit

JAR OPS REQUIREMENTS

It is a requirement of JAR OPS that aircraft shall be equipped with a cockpit voice recorder capable of retaining recorded information as follows:

- during at least the last **30 minutes** of its operation for an aircraft registered **before 1 April 1998** and is:
 - 5700 kg or less **and** having more than 9 seats, **or**
 - over 5700 kg
- during at least the last **2 hours** of its operation for an aircraft registered on or **after 1 April 1998** and is:
 - multi-engine turbine powered with more than 9 seats, **or**
 - over 5700 kg

The other JAR OPS requirements are:

- The CVR must be capable of recording:
 - voice communications transmitted from or received on the flight deck by radio
 - the aural environment of the flight deck, including where practicable, without interruption, the audio signals received from each boom and mask microphone in use.
 - voice communications of flight crew members on the flight deck using the aeroplanes interphone system.
 - voice or audio signals identifying navigation or approach aids introduced into a headset or speaker and
 - voice communications of flight crew members on the flight deck using the public address system, if installed.
- The CVR must start to record prior to the aeroplane moving under its own power and continue to record until the termination of the flight when the aeroplane is no longer capable of moving under its own power.
- The CVR must have a device to assist in locating the recorder in water.
- An aeroplane may be dispatched with an inoperative CVR provided that:
 - it is not reasonably practicable to repair or replace the CVR before flight
 - the aeroplane does not exceed 8 further consecutive flights
 - not more than 72 hours have elapsed since the unservicability
 - any flight data recorder required to be carried is operative (unless it is combined with the CVR)

QUESTIONS

1. An altitude alerting system must at least be capable of alerting the crew on:
 1. Approaching selected altitude
 2. Abnormal gear/flap combination
 3. Excessive vertical speed
 4. Excessive terrain closure
 5. Excessive deviation from selected altitude
 6. Failure to set SPS or RPS as required
 - a. 1&3
 - b. 2&5
 - c. 4&6
 - d. 1&5

2. According to JAR OPS subpart K, when must the DFDR on a 12 seat turbo prop a/c begin recording?
 - a. Switch on until switch off
 - b. From before the aircraft is capable of moving under its own power to after the a/c is no longer capable of moving under its own power
 - c. From lift off until the weight on wheels switch is made on landing
 - d. At commencement of the taxi to turning off the runway

3. What is the EGPWS mode 3 audible alert?
 - a. "don't sink, don't sink" followed by "whoop, whoop, pull up" if the sink rate exceeds a certain value.
 - b. "don't sink, don't sink" followed immediately by "whoop, whoop, pull up".
 - c. "don't sink, don't sink" continuously.
 - d. "Terrain, don't sink" continuously.

4. What are the inputs to a modern jet transport aeroplane's stall warning system:
 1. A.o.A
 2. Engine RPM
 3. Configuration
 4. Pitch and bank information
 5. Control surface position
 6. Airspeed vector
 - a. 1,2,3&4
 - b. 2,4,5&6
 - c. 1,2,3&6
 - d. 2,3,4&5

5. EGPWS may indicate:
1. Excessive sink rate after T/O
 2. Excessive descent rate
 3. Excessive closure
 4. Ground proximity, not in the landing configuration
 5. Deviation from glide-slope
 6. Proximity to en-route terrain
- a. 1, 4 & 6
 - b. 2, 3 & 5
 - c. 1, 3 & 5
 - d. 2, 4 & 6

ANSWERS

1	2	3	4	5
D	B	C	C	A

ATPL GROUND TRAINING SERIES

Aircraft General Knowledge 4



CHAPTER THIRTY NINE
ENGINE INSTRUMENTATION

Contents

AN INTRODUCTION TO THE ENGINE INSTRUMENTS..547
TYPES OF DISPLAY548
THRUST AND POWER MEASURING INSTRUMENTS.548
ENGINE TORQUE.550
ENGINE R.P.M.553
TEMPERATURE SENSING EQUIPMENT557
PRESSURE GAUGES561
ENGINE VIBRATION564
FUEL GAUGE565
REMOTE (SIGNAL) TRANSMISSION SYSTEM570
FLIGHT HOUR METER.572

AN INTRODUCTION TO THE ENGINE INSTRUMENTS.

Just as it would be impossible to fly a large modern aircraft safely without the flight instruments, so would it also be impossible to fly it safely without the engine and aircraft systems instruments.

The engine instruments are divided basically into two categories, **Performance Indicators** or **Engine Condition Indicators**.

Performance Indicators are thrust indicating instruments such as the Engine Pressure Ratio (E.P.R.) gauge or the Fan Speed (N1) gauge.

Engine Condition Indicators include the Exhaust Gas Temperature (E.G.T.) gauge, Compressor Speed, Oil Pressure and Oil Temperature gauges. We will be discussing these and others in the following text.

Figure 39.1 shows some of the parameters previously mentioned and the position of the sensors that are required to measure them.

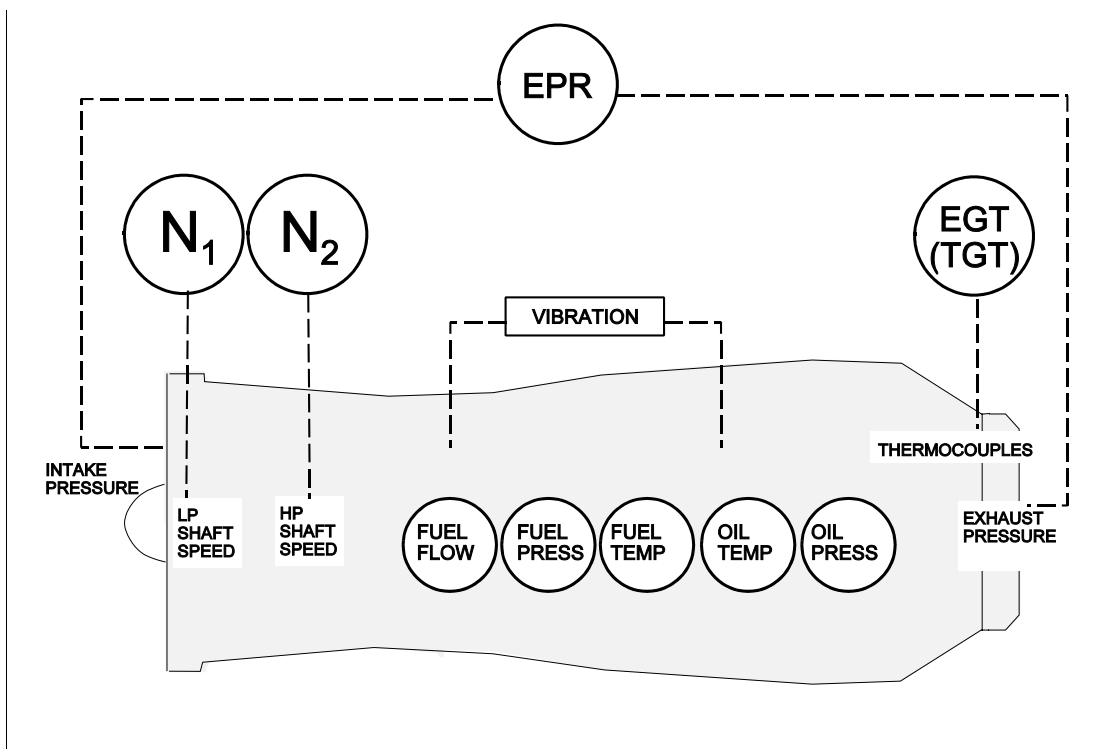

Figure 39.1. Some of the Parameters Required to be Displayed.

TYPES OF DISPLAY

There are two types of cockpit display, the analogue display (clockwork cockpit), or the electronic display (glass cockpit). This is covered in Chapter 22.

In the former, there are a multitude of gauges displaying information, in the latter the display is shown on cathode ray tubes (C.R.T.s) or liquid crystal display panels (L.C.D.s) with light emitting diodes (L.E.D.s) for digital displays. A small number of conventional gauges are retained in case of failure of the electronic displays.

Both types of display convey essentially the same information to the pilot, but the flexibility of the Glass Cockpit system means that it is now taking over as the preferred means of showing both flight and engine instrumentation.

THRUST AND POWER MEASURING INSTRUMENTS.

Thrust measuring instruments are of two basic types:

- the type that measures the jet pipe pressure, the **P7 gauge**.
- the type that measures the ratio of two parameters, the jet pipe pressure and the engine air intake pressure, the **E.P.R. gauge**. (Figure 39.2)
- propeller driven aircraft measurer and indicate **Torque**. This is an indication of engine power. The propeller converts power into thrust.

On some large turbo-fan engines the integrated turbine discharge pressure and fan outlet pressure is compared to the compressor inlet pressure to produce what is called 'integrated' E.P.R.

Pitot tubes, suitably positioned, sense the pressures which are required to work the system, the tubes can either be connected directly to the indicator in the cockpit or to a pressure transmitter which is electrically connected to the indicator.

The P7 system gauge can be marked in inches of mercury (in Hg), pounds per square inch (p.s.i.), or a percentage of the engine's maximum thrust.

Although E.P.R. can be indicated by either mechanical or electronic means, it is more normal to find the electronic system in use. This system uses two transducers which sense the relevant air pressures and vibrate at frequencies proportional to these pressures. A computer works out the electrical signal appropriate to the pressures and that signal is sent to the E.P.R. gauge in the cockpit and to the engine management system.

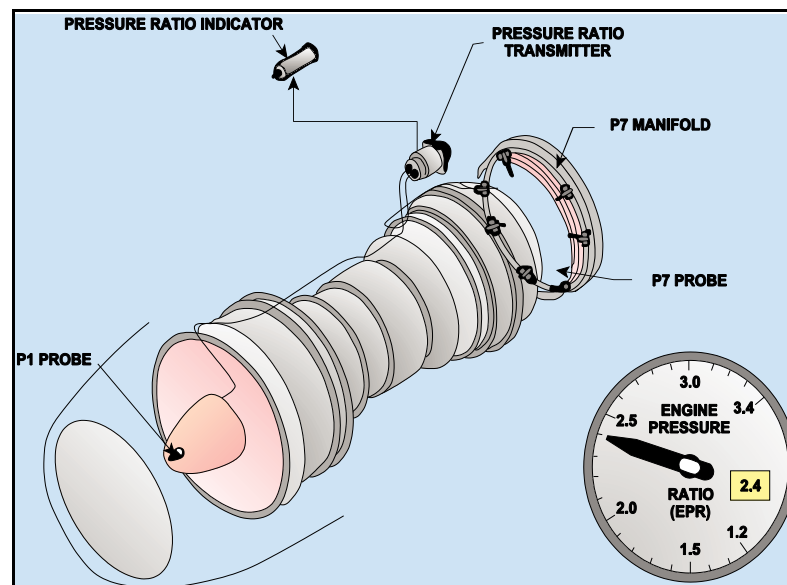

Figure 39.2 The Engine Pressure Ratio (E.P.R.) Indicating System

The engine intake pressure will vary with changing ambient pressure and also with changing airspeed. An increase in forward airspeed during take off will cause a drop in the reading on the E.P.R. gauge. This is only an 'apparent drop' because it is only the ratio of two pressures, engine intake pressure and the jet pipe pressure, which is changing.

This apparent change is caused by a relative increase of the engine intake pressure with forward airspeed during take off. The jet pipe pressure being unaffected at low airspeeds, which causes the ratio between the two pressures to fall.

This will be seen as a reduction in E.P.R. on the gauge, which might cause the inexperienced engine operator to open the throttles further in an attempt to restore the loss, having eyes for only the one parameter, while the other parameters, (N1, N2, N3 & E.G.T.) are in danger of exceeding their limits without his knowledge.

In an attempt to prevent this happening, most operators require that E.P.R. is set before the aircraft has reached approximately 60 knots, no increase in engine power being allowed unless in emergency after this speed.

After take off, as the airspeed increases beyond V₂, the increase in engine intake pressure is passed through the engine to the jet pipe, so changing the ratio back to that set on take-off.

ENGINE TORQUE

Turbo-props and turbo-shaft engines produce torque rather than thrust. The systems that produce indications of thrust for turbo-jet engines and turbo-fan engines are vastly different to those which produce indications of torque for turbo-prop and turbo-shaft engines. The Torque meter measures, and its indicator displays the power being produced by the engine. Torque by definition is a force applied at a distance to a turning point. If applied to the **PLANE** formula given in piston engines chap 1, the turning force is the product of the mean effective pressure **P** acting on the area of the piston **A** at distance **L** (the stroke is twice the throw of the crank) Therefore **P, L & A** can be replaced by the word **Torque**. **N** represents the number of cylinders and will remain constant, the only other variable is **E** the number of effective power strokes or RPM of the engine. **Power** can therefore also be expressed as **Torque x RPM**.

There are two main methods employed in measuring the torque of the engine. One uses oil pressure and the second is an electronic device. The units of measurement vary from system to system. The indicator gauges may be calibrated to read, P.S.I., Inch or Foot pounds, Newton metres, Brake or Shaft Horsepower. Torque is measured between the engine and the reduction gearbox.

The oil torque meter system makes use of a phenomenon that axial thrust (movement) is generated when **helically cut gears** are used to transfer power from one shaft to another. Figure 39.3 shows how this end thrust can be utilised to provide an indication of the torque output of a turbo-prop or turbo-shaft engine.

As the gears in the propeller reduction gearbox rotate to drive the propeller, the amount of torque that they are transmitting attempts to move them axially, this axial force is proportional to the torque that is producing it.

The gears cannot be allowed to move axially because this would cause the teeth to no longer mesh with each other and the drive would fail, the axial force has to be counteracted to maintain the gears in alignment. The force comes from passing engine oil through a filter and then to a torquemeter pump which enables its pressure to be boosted to (in some cases) as much as 800 p.s.i.. This high pressure is allowed into cylinders which form the bearings within which the helical gear shafts rotate.

A small bleed hole in the wall of the cylinder will be covered by the gear shaft if it moves into the cylinder under increasing axial load, this will cause the oil pressure within the cylinder to build up until it can move the gear shaft back to its original position. Conversely, if the load on the helical gear shaft decreases, the existing oil pressure will force its shaft slightly out of the cylinder. This uncovers the bleed hole allowing the balancing oil pressure to be reduced and so the gear shaft moves back into correct position within the cylinder.

If the oil pressure balancing the axial force is measured, it can be compared with reference figures which take into account the ambient pressure and temperature and the performance of the engine, its power output, can be judged.

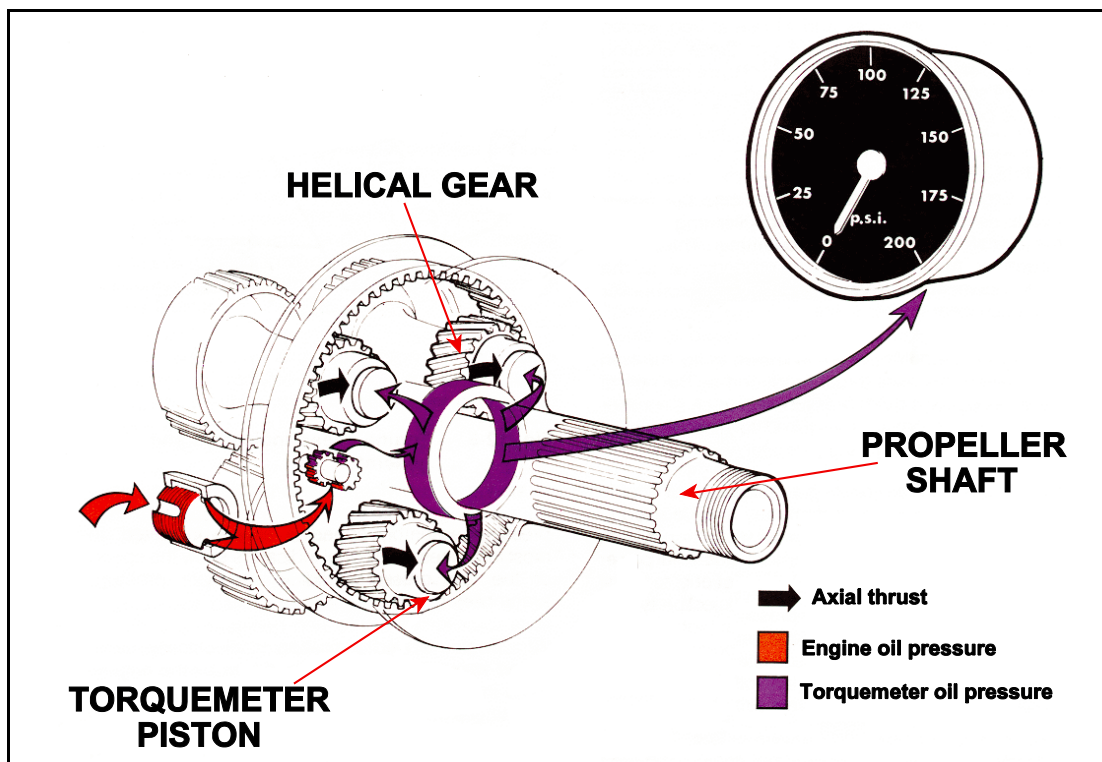

Figure 39.3 The Torquemeter System

The Electronic system comprises of two concentric shafts. One, the **Torque Shaft**, is connected to both the engine and the **propeller's reduction gear box**. The second shaft, the **Reference Shaft**, is connected only to the engine. An exciter wheel (toothed gear) is formed at the forward end of each shaft. The exciter wheels rotate past an electro magnetic pick-up and produce an AC voltage. The exciter wheels are aligned at assembly, but as power is increased the torque shaft twists, this displaces the phase relationship of the voltages produced. The displacement is proportional to the change in power, and is used to drive an indicator. This system is simple, and lighter than other systems and has proven to be very reliable in service. (Figure 39.4)

The torque indicator may indicate negative (windmilling propeller) as well as positive torque. The torque limits are colour coded and shown on the gauge. A red coloured band or marker indicating maximum limits. On a FADEC system these limits may be adjusted and set by the crew, the indication can be presented in a digital readout.

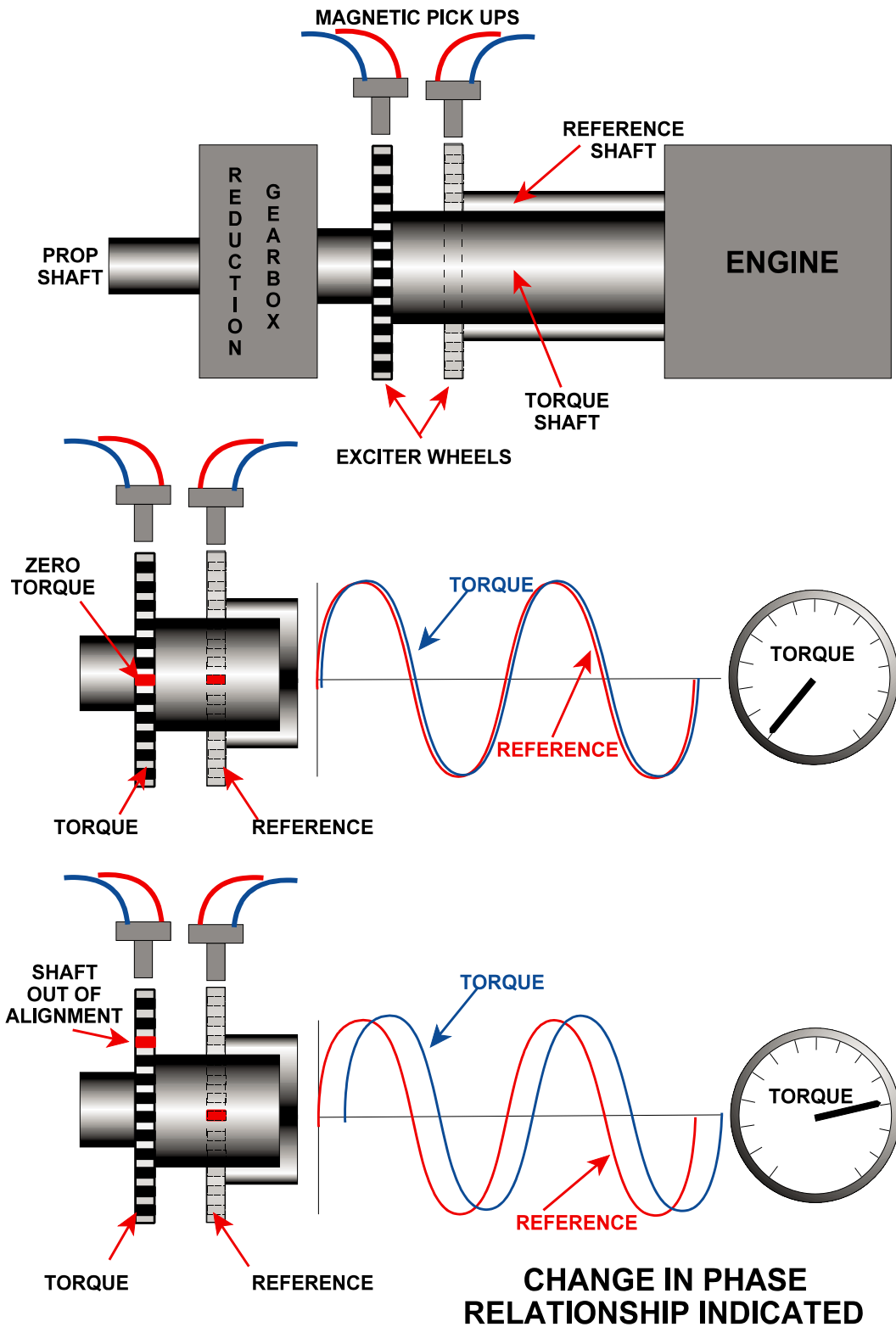

Figure 39.4 Electronic Torquemeter

ENGINE R.P.M.

The measurement of engine speed is of vital importance, since together with other parameters accurate control, and monitoring of the engine can be achieved. On piston engines it is crankshaft speed that is measured, whilst on gas turbine engines it is the speed of the compressor. The RPM indicator is called a **Tachometer (Tacho)**. There are three basic methods of measuring engine rotational speeds:

- **Mechanical (Magnetic) Tachometer.**
- **Electrical Generator System. (Tacho Genny)**
- **Inductive Probe System.**

There are no firm guidelines as to the application of each of the tachometer system, although engine and aircraft design will dictate which system can be best utilised.

The **Mechanical Tachometer** (Figure 39.5) is now only found on older piston aircraft. It consists of a **Flexible Drive Shaft** that is connected to the flight deck **Tacho Indicator**. The input drive causes a magnet in the indicator to rotate. The magnet rotates inside a copper or aluminium drag-cup, this induces **Eddy Currents** in the drag-cup which opposes the magnetic field of the magnet. A torque is established which turns the drag-cup in the same direction as the permanent magnet. A shaft extends from the drag-cup and is connected to a pointer. The turning motion of the pointer is against the tension of a **Hairspring** which controls the drag cup position and hence the position of the pointer. The flexible drive is driven at reduced speed, but true speed will be shown on the indicator. The indicator incorporates compensation devices for change in temperature.

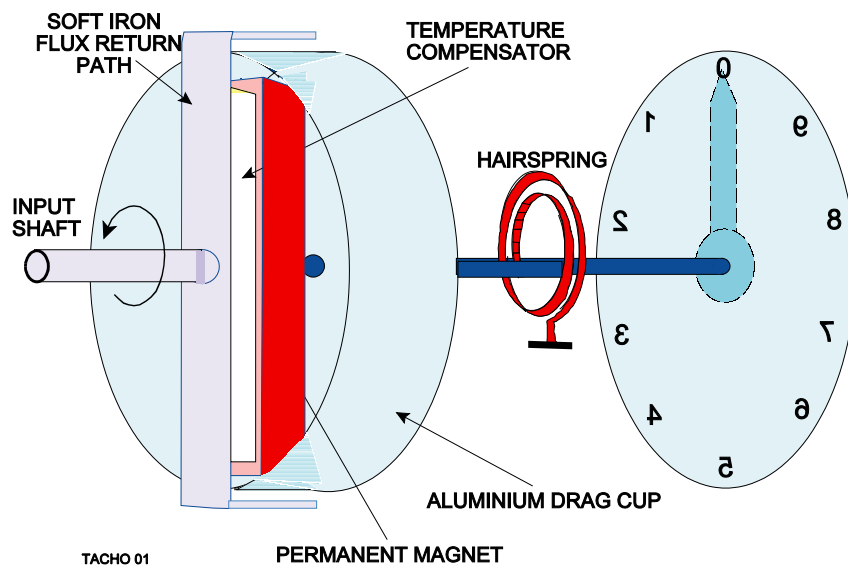

Figure 39.5 Mechanical Tacho

The **Electrical Generator System** (Figure 39.6) is possibly the oldest form of engine speed measurement still in use on large aircraft. It utilises a small three phase (tacho) generator, driven by the engine. The output of this generator is then taken to an indicator which consists of a synchronous motor turning a drag cup assembly which moves a pointer over a scale as in the mechanical system.

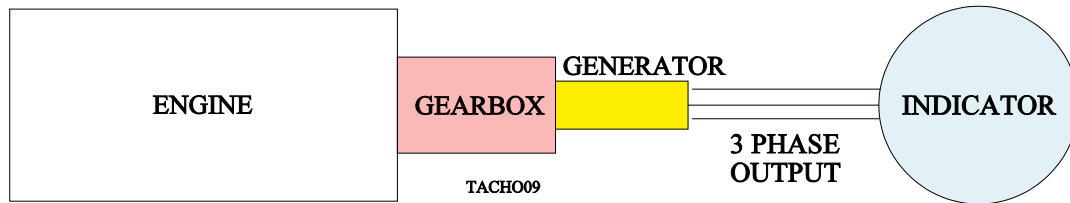

Figure 39.6 Tacho-Generator

The indicator (Figure 39.7) can either show the actual revolutions per minute (not too common), or the speed as a percentage of maximum engine speed.

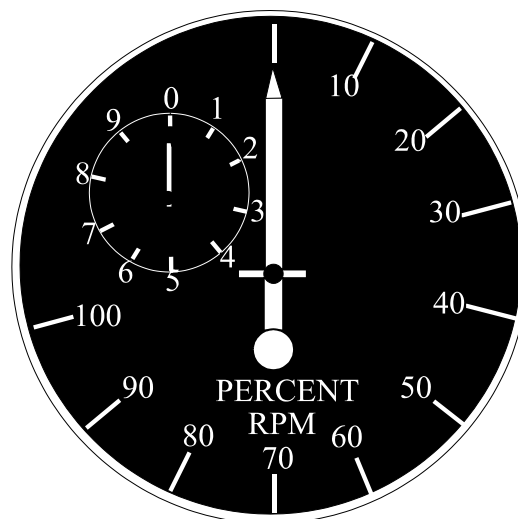

Figure 39.7 Percentage Tacho-Indicator

On twin or triple spool engines the speed of rotation of the high , intermediate and low pressure compressors can be displayed. These would be termed N3, N2 and N1. N being the SI symbol for rotational speed.

An overspeed pointer (Trailing or Limit pointer) can also be fitted concentrically with the main pointer, and is initially positioned at the appropriate max RPM graduation. If the main pointer exceeds this position, the limit pointer is carried with it. When speed is reduced the limit pointer will remain at the maximum speed reached. It can be reset by applying a separate 28V DC supply to a solenoid in the indicator.

Although there would always be provision on the H.P. compressor spool for driving a tacho-generator through the high speed gear box. Facilities may not always be available for driving tacho-generators from the intermediate and low pressure compressor shafts. If this is the case, a **Speed Probe**, shown in Figures 38.8 and 38.9, can be used to very good effect.

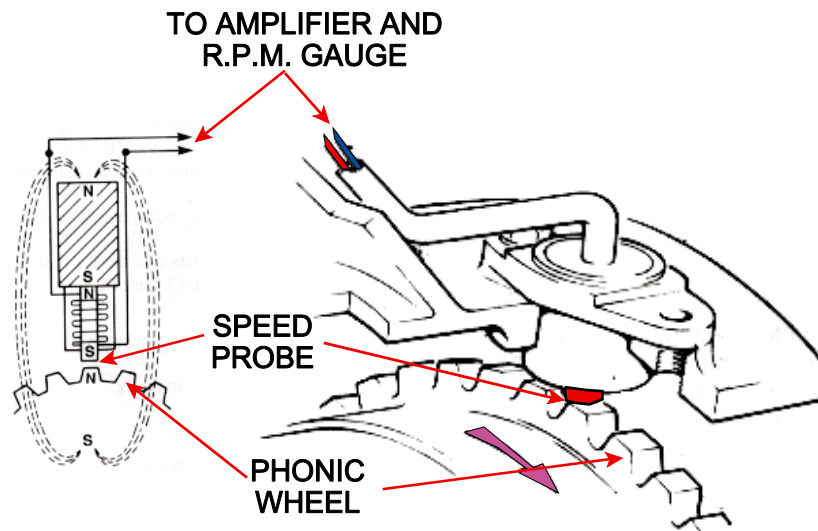

Figure 39.8 Measuring Engine Speed With a Phonic Wheel and a Speed Probe

The speed probe is positioned on the compressor casing in line with either a phonic wheel (Figure 39.8), or the actual fan blades (Figure 39.9). As the spool rotates, the magnetic flux in the probe or sensor head is altered. This changes the current flowing in the coil fitted inside the probe and the frequency with which it changes is directly related to the spool speed. This frequency is fed to an indicator in the cockpit to show the spool rotational speed.

In addition to providing an indication of spool speed, the tacho-generator or speed probe can both be used to provide a signal which will illuminate a warning lamp on the engine start control panel. This can tell the pilot not only that the engine is turning, but also whether the engine is turning in the correct direction. This is particularly important during engine start as it is used to inform the pilot when to open the H.P. Fuel Cock. This lamp is only illuminated during the start cycle.

An advantage of this system is the reduction in moving parts required in the engine, and that a number of separate electrical outputs additional to those required for speed indications can be provided, e.g. automatic power control and flight data acquisition systems.

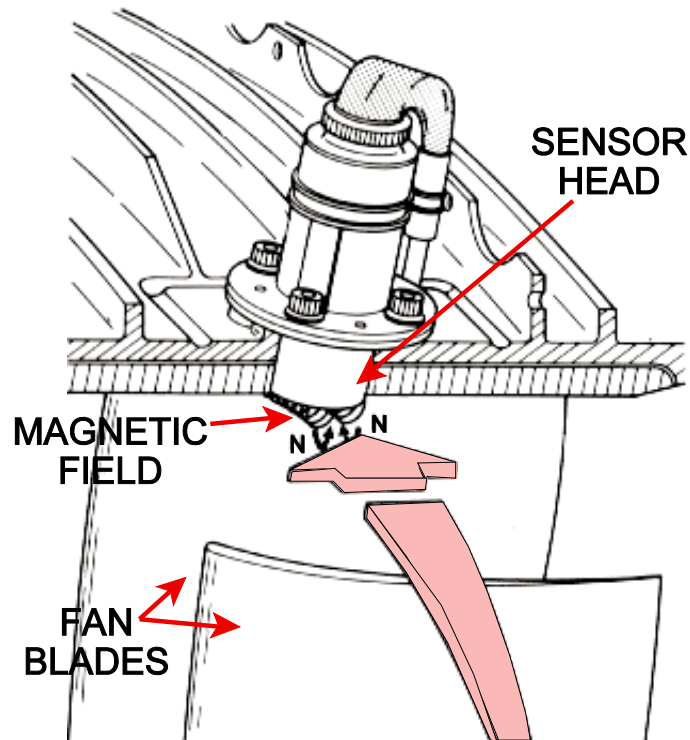

Figure 39.9 The Use of a Speed Probe to Measure Fan Speed

The Tacho indicators mentioned in the text above receive their speed signals directly from speed sensors or via servo operated systems. These indicators require a power source from the aircraft airborne power supply. In the event of power supply or signal failure, the indicator is returned to an **Off Scale** position, and a **Power Off Flag** may be displayed.

As previously stated, presentation of speed is now usually displayed as a percentage figure. It is only piston engine aircraft where the actual speed of rotation is displayed. Gas turbine engines have dial displays which show percentage speed, with 100% corresponding to the optimum turbine speed. Two scales are displayed, a main scale calibrated 0 to 100% in 10% increments. A second pointer or digital counter displays speed in 1% increments. As well as digital read out vertical ribbon displays are used.

In line with other instruments, coloured arcs or indicators lines are used to show ranges and limits of engine speed. Green representing normal operating range, with Amber denoting caution. Red arcs show maximum or minimum speed, and ranges that are restricted because of excessive vibration.. On a piston engine the reference RPM should also be placarded.

On multi-engine aircraft, to reduce structural vibration and noise the speed of all engines must be synchronised. It is impractical to have the pilot adjust the throttle of each engine manually to synchronise the speed, and individual indicators may vary in accuracy. In order to facilitate manual adjustment of speed an additional instrument known as a **Synchroscope** (Figure 39.10) is used. The instrument was designed at the outset for operation from the AC generated by the tachometer system. The instrument provides qualitative indication of the difference in speeds between two or more engines. One engine is selected as a master, the others are slaves to it. The instrument shows clearly whether a slave engine is running faster or slower than the master. An example of the dial presentation for synchrosopes for a Twin and Four-engine aircraft, and Combined tacho and Synchroscope are shown.

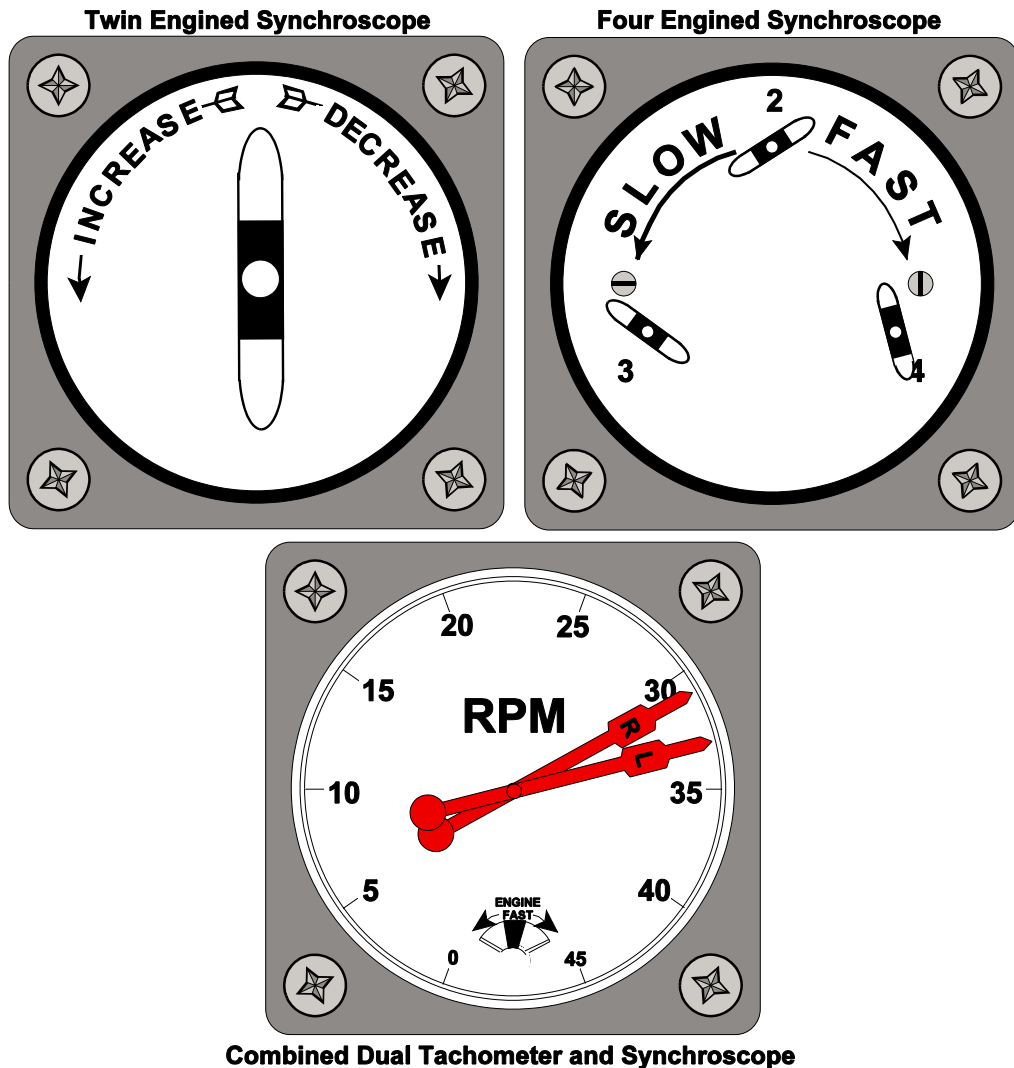

Combined Dual Tachometer and Synchroscope

Figure 39.10 Synchrosopes

TEMPERATURE SENSING EQUIPMENT

Piston and gas turbine aero engines are heat engines. The power they produce is directly proportional to the heat released during combustion of fuel. Engine components and systems are designed to withstand certain temperatures. If their limits are exceeded they may fail. To allow safe operation the engine temperatures must be monitored. The effect of ambient temperatures as well as combustion must be considered. The following temperatures are monitored on piston and gas turbine engines: Air Inlet, Piston Cylinder Heads, Piston Exhaust Gas, Gas Turbine Compressor outlets, Turbines Oil and Fuel systems and Internal Air system.

The temperatures monitored may range from -56°C to +1,200°C. Different sensors are used depending on the temperature range to be monitored. They fall broadly into two categories, High temperatures and low temperatures.

There are four major types of measuring devices. They are:

Expansion Type

This relies on the principle that most solids, liquids and gases expand and contract with temperature changes. e.g. The mercury Thermometer and Bi-metallic strip

Vapour Pressure Type

Liquids when subjected to a rise in temperature change their state from liquid to vapour. Therefore by measuring the pressure of the vapour an indication of temperature can be gained.

Electrical Type

A change in temperature of an electrical conductor can cause a change in resistance of the conductor. Thus measuring the change in resistance can indicate the temperature of the conductor. This sensor is called the **Resistance Type** (Temperature Bulb.. In addition, two dissimilar metals when joined together at their ends (a junction) can produce an electrical potential called a thermo EMF(Seebeck Effect). This is dependant on the temperature difference between the junctions. This is known as a '**Thermo-Electric Type**' or '**Thermo-couple**'. This system is explained in detail later.

Radiation type

The radiation emitted by any body at any wavelength is dependant upon the temperature of that body. This is termed its 'emissivity'. If the radiation is measured and the emissivity is known the temperature of the body can be determined. Such a measuring technique is known as **Pyrometry**.

Generally the Expansion and Vapour Pressure sensors are used to indicate lower temperatures. They are direct reading. e.g Thermometer. The Electrical and Radiation sensors are used to measure higher temperatures and can be direct reading to a moving coil Indicator. e.g. Piston Engine Exhaust Gas Temperature. However most systems today use remote sensors that feed to servo-operated indicators after the signal from the sensor has been amplified. A **Ratiometer-Type** indicating system can be used to obtain the greater accuracy required when indicating the temperature of critical component (Turbines).

The temperature of the gas passing through the turbine in a gas turbine engine is the most important parameter of those displayed on the engine instruments. Operation of the engine beyond the limits of turbine temperature, even for only a moment, is liable to cause excessive turbine blade creep which can be catastrophic if the rotating blades touch the casing of the engine.

The gas temperature must be monitored closely and automatic temperature limiting equipment is fitted to most gas turbine engines operating today. To enable this monitoring to be achieved temperature probes are inserted in the gas stream.

Temperature probes are formed from the junction of two dissimilar metals, when heated the junction generates a small voltage which is proportional to the actual temperature which produced it. The voltage can be measured on a milli-voltmeter and displayed in the cockpit as the temperature at the rear of the engine. A **Galvanometer** is a very sensitive instrument used to indicate these low voltages. The galvanometer uses a basic **Wheatstone Bridge Balancing** circuit that alters the magnetic field in a coil, this change produces a torque to drive an indicator.

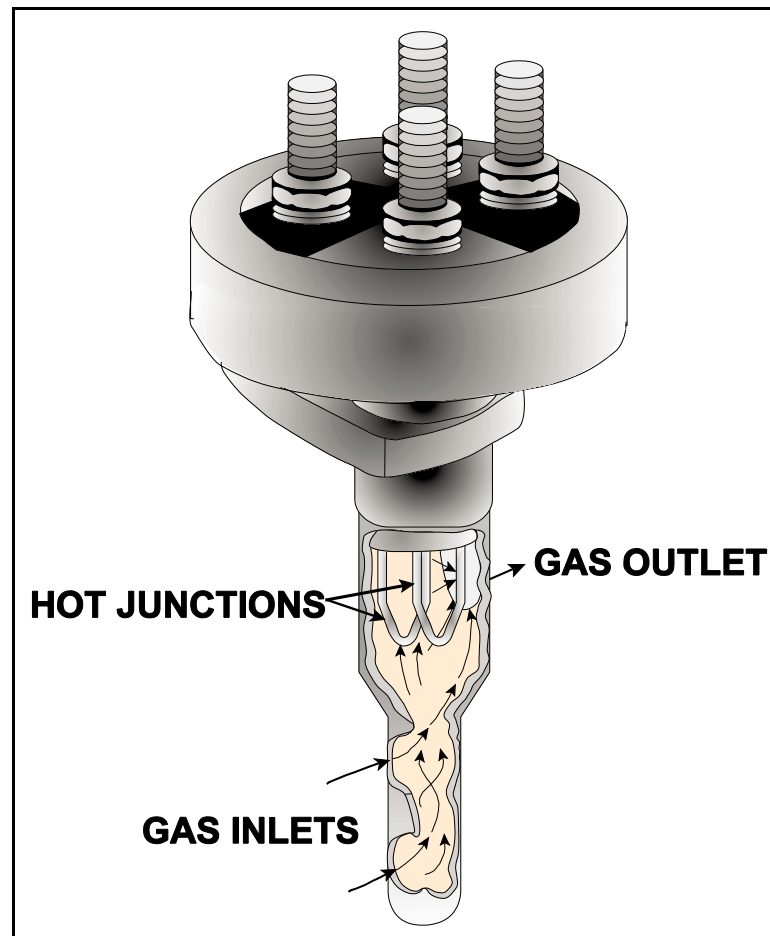

Figure 39.11 The Gas Flow Over the Probes and Their Electrical Connections.

Figure 39.11 shows how the probes, the hot junctions, are connected and also how the gas flows over them. The output from the probes is sent to the cockpit engine instrument, which is the cold junction, where the e.m.f. is measured on a very sensitive milli-voltmeter to display the engine gas temperature.

Just one probe would obviously not supply enough information to accurately tell the pilot what was going on in the whole turbine, it could only inform him about the small part of the turbine that it was monitoring. It is therefore necessary to place a number of probes, **electrically connected in parallel**, all around the periphery of the engine or the exhaust system, this means that the gas stream is sampled in many more places and that the output is the average of all of the probes. This has an added advantage that **if one probe is damaged, the temperature reading on the gauge is virtually unaffected.**

The actual position of the probes depends upon two things, the anticipated maximum temperature of the gas, and the ability of the probe material to withstand that temperature

The industry standard for the material used in the temperature probes in gas turbine engines is chromel (nickel chromium), and almel (nickel aluminium). These two materials may not have the highest milli-voltage output of the materials available, but their ability to withstand very high temperatures coupled with a reasonable volts / degree ratio makes them ideal for the job.

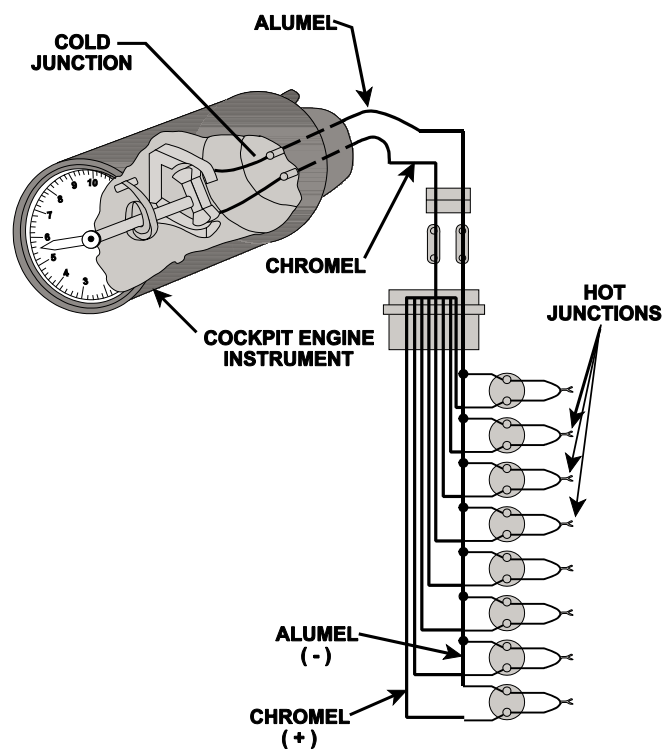

Figure 39.12 Thermocouple indicating System.

Note: The system requires no power supply to indicate temperature.

However if the signal is to be used to supply a temperature limiting system the voltage will need to be amplified. This will be supplied by the aircraft's electrical system.

In the case of a system that supplies both a temperature limiting system (top temperature control) and a temperature indicating system, the probes will contain two hot junctions, one to feed the limiter and one to feed the indicator. As illustrated in Figure 39.11

The positioning of the probes within the engine depends on the temperature of the gas and the ability of the metal they are made of to withstand it. On engines where the temperature of the gas within the turbine is too high for the metal of the probes to stand it, they may be positioned after the turbine and the gauge calibrated to read 'exhaust gas temperature' (E.G.T). On other engines, it may be found convenient to combine the temperature probes with the pitot probes which measure exhaust gas pressure (P7), in this case the gauges will read 'jet pipe temperature' (J.P.T.).

Obviously it would be ideal if the temperature could be sampled either before the turbine, called either 'turbine inlet temperature' (T.I.T.), or 'turbine entry temperature' (T.E.T.), or inside the turbine, called 'turbine gas temperature' (T.G.T.), in every case the position of the probes is dependent upon their ability to withstand the temperatures they encounter.

Actual blade temperature can be measured by the radiation method, with the use of an **Optical of Pyrometer**.

Air temperature is one of the basic parameters used to establish data vital to the performance monitoring of aircraft engines. e.g thrust settings, fuel/air ratios settings etc. The temperature ideally required is that sensed at static conditions at various flight levels. This is called **Static Air Temperature (SAT)**. However this is not possible for all types of aircraft or, in many instances, for one type of aircraft, for the measurements can be effected by the adiabatic compression with increase speed. Below 0.2 Mach the temperature is very close to SAT, but at higher Mach Nos an increase in skin friction will raise the air temperature. This increase is commonly referred to as '**Ram Rise**', and the temperature indicated called **Ram Air Temperature (RAT)** i.e. SAT plus the ram rise. The ram rise can be calculated mathematically as a function of Mach No, and for each type of aircraft tables or graphs can be included in flight manuals, or computed by air data computers to correct the indicators to SAT. The proportion of ram rise dependant on the ability of the sensor to sense or recover the temperature rise. The sensitivity in this case being expressed as a percentage and termed **Recovery Factor**. If for example , a sensor has a recovery factor of 0.80, it will measure SAT plus 80% of the ram rise.

For use at high Mach Nos **Total Air Temperature (TAT)** is measured. The air is brought to rest (or nearly so) without addition or removal of heat. The temperature probes used have a high recovery factor (approximately 100%). TAT is equal to SAT+Ram Rise.

Temperature indicators use coloured arcs to show their operating range. Green for normal, Amber for caution and Red upper or lower limits.

PRESSURE GAUGES

In many of the systems associated with the operation of the aircraft and its engines, liquids and gases are used the pressures of which must be measured and indicated. The gauges and indicating systems fall into two categories: **Direct Reading** and **Remote Indicating**. Remote indicating is where a separate sensing element is connected to a pressure source at some remote point.

Pressure, is defined as force per unit area. It is normally indicated either as **Pounds Per Square Inch (PSI)** or **Inches of Mercury (in Hg)**. In connection with pressure measurement we are concerned with the following terms: **Absolute Pressure** and **Gauge Pressure**. Most pressure gauges measure the difference between absolute pressure and the atmospheric pressure. This is gauge pressure.

To actually measure pressure in a system **Elastic Pressure Sensing Elements** are used in which forces can be produced by applied pressures and converted to mechanical movement. The movement can then operate a direct reading gauge or electrical transmitter. The sensing elements commonly used are **Diaphragms, Capsules, Bellows and Bourdon tubes**.

Diaphragms (Figure 39.13) consist of corrugated circular metal discs which are secured at their edge, and when pressure is applied they are deflected. Diaphragms are used to measure low pressures.

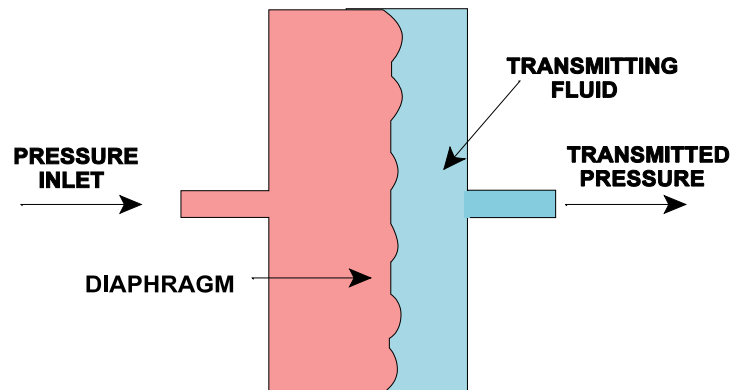

Figure 39.13 A Diaphragm Pressure Sensor

Capsules (Figure 39.14) are made up of two diaphragms placed together and joined at their edges to form a chamber which may be sealed, called an **Aneroid**, or open to a pressure source and called a **Pressure capsule**. Like diaphragms they are used to measure low pressure, but they are more sensitive to small pressure changes.

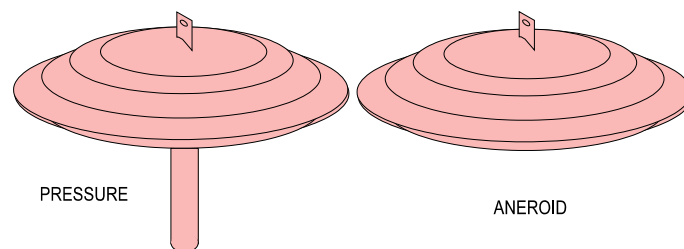

Figure 39.14 Pressure and Aneroid Capsules

The bellows (Figure 39.15) type element can be considered as an extension of the corrugated diaphragm principle. It may be used for High, Low or differential pressure measurement. It is typically used to measure pressures like the aircraft's LP Booster pump output.

The Manifold Absolute Pressure Gauge or **MAP** (Figure 39.17) of a piston engine measures both pressure and differential pressure. Note this gauge measures **Absolute Pressure** and indicates inches of mercury (in Hg.). When the engine is running this gauge can indicate less than atmospheric pressure. Earlier versions of this gauge were calibrated to read **Boost in PSI** and called **Boost Gauges**. Under standard conditions the Boost Gauge will read 'Zero' and the MAP gauge will read 30 in Hg. This indication is called **Static Boost**.

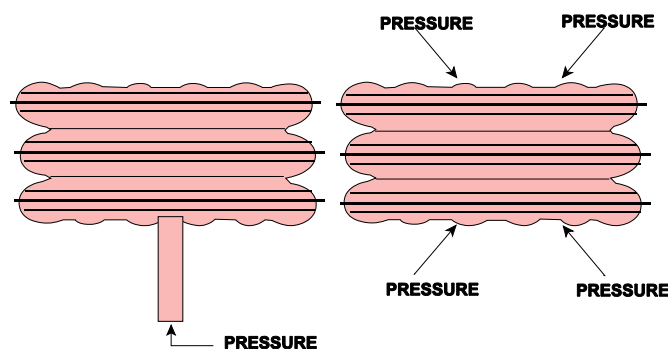

Figure 39.15 Bellows Sensors

The Bourdon tube (Figure 39.16) is about the oldest of the pressure-sensing element. The element is essentially a length of metal tube with an elliptical cross section, and shaped into a letter C. One end of the tube is sealed, and called the free end. The other end is connected to the pressure source and fixed. When pressure is applied the tube tries to straighten, this movement is magnified to drive an indicator pointer. The Bourdon tube can be manufactured to indicate high or low pressures, but is normally associated with higher pressures such as engine oil pressure.

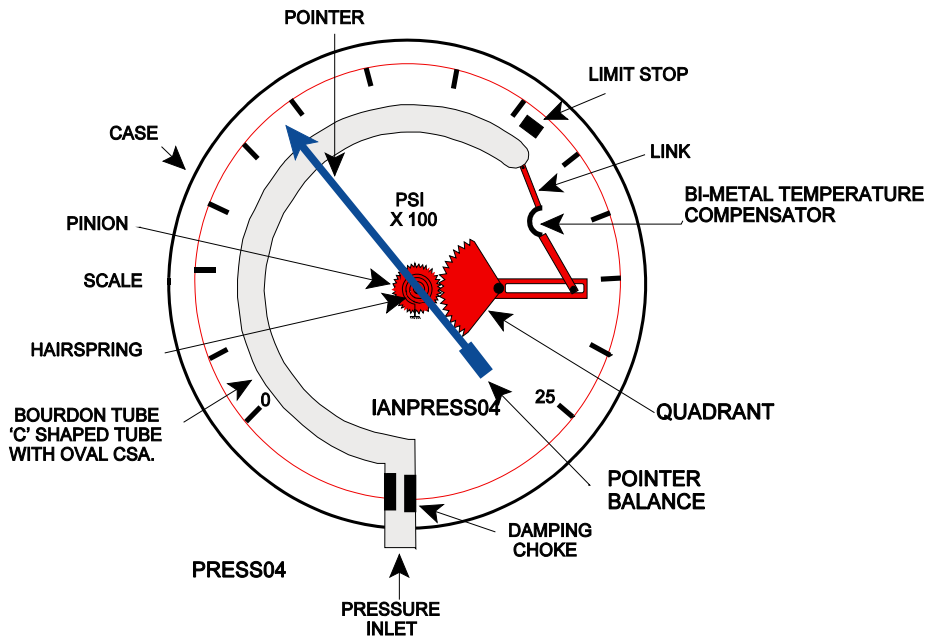

Figure 39.16 The Bourdon Tube

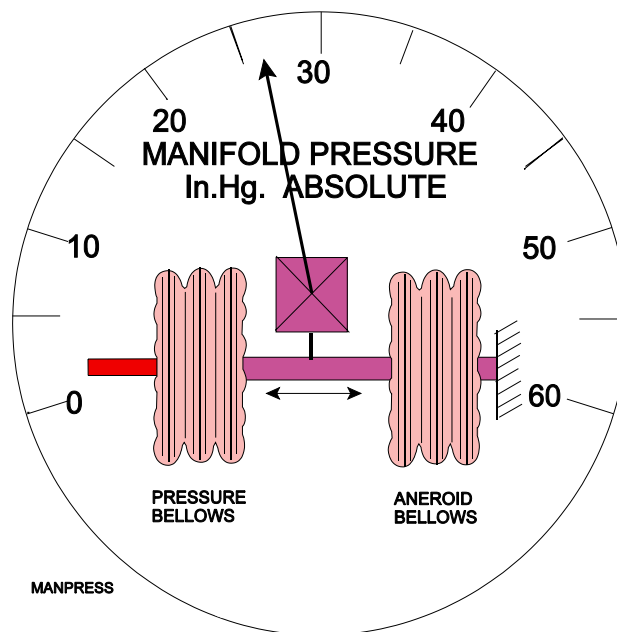

Figure 39.17 Manifold Absolute Pressure Gauge.

It would be impractical to run an oil feed pipe from the outer engine of a Boeing 747 to a flight deck pressure indicator of the Bourdon tube type. To overcome this problem remote-indicating systems are used. They consist of two main components, a transmitter unit located at the pressure source, and an indicator mounted on the appropriate panel. They have distinct advantages over direct-reading gauges; for example, the pressure of hazardous fluids can be measured at their source and not brought into the cockpit. Also weight can be saved by reducing the length of pipelines. The transmitters feed varying current to an indicator and can be AC or DC in operation. These systems are covered later

As well as indicating actual pressures, warnings can be displayed to the pilot by pressure operated switches. These switches can operate for Low, High or incorrect Differential pressures. A differential Switch or gauge is subjected to pressure on both sides of its sensor

Coloured arcs of Green, Amber or Red are used to indicate the range and limits of the system.

ENGINE VIBRATION

Vibration monitoring equipment (V.M.E.) is fitted to almost all commercial jet engined aircraft. Although gas turbine engines have an extremely low vibration level, any change in that level is usually indicative of damage which may lead to failure.

Warnings will be given in the cockpit if the vibration levels are exceeded and some systems have a continuous readout of vibration levels.

The latest engines have the facility whereby the vibration level of each rotating assembly is monitored so that the source of the vibration can be pin pointed.

The principle upon which V.M.E. works requires either an input from a **Piezo** electric crystal mounted strategically on the engine, or an input from a coil which will be affected by the movement of a **Magnet** mounted loosely within it. In either case, the frequency of the incoming vibrations will be filtered so that only those frequencies that are indicative of damage occurring will affect the output.

These systems utilise the principle that the magnet and piezo crystal which are suspended within a fixed coil carrying 115 volts at 400 Hertz, will move in sympathy with any vibration suffered by the engine. This will affect the current flowing through the coil into the amplifier and filter. The filter will erase any output which is normal to the engine, and allow through to the amplifier any frequency that is considered to be harmful to the engine.

The result of this amplification is sent to the instrument via the rectifier and warning circuit. The needle will show the appropriate deflection for the amount of vibration being suffered by the engine at that time. If the level of vibration exceeds a predetermined amount, a warning light on the instrument illuminates. Vibration is measured and displayed in '**Relative Amplitude**' (Rel Ampl)

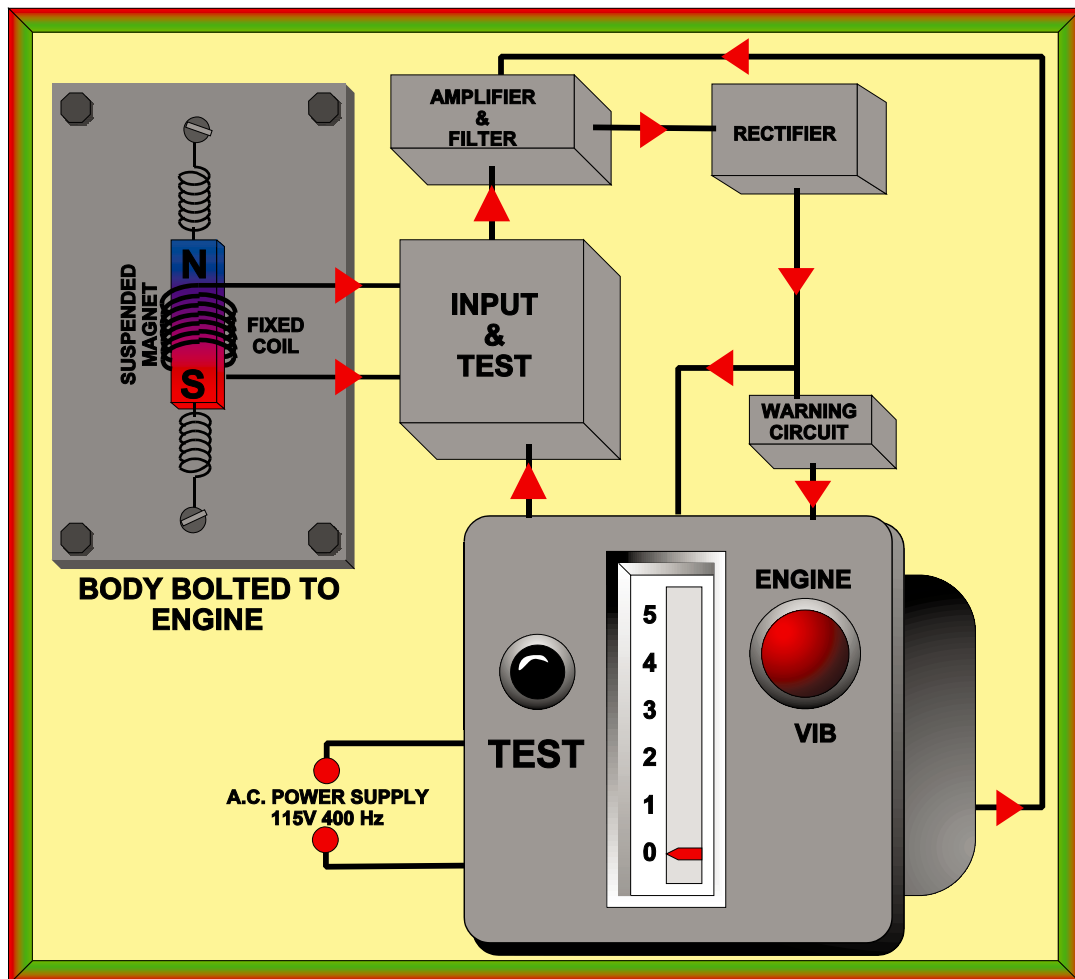

Figure 39.18 The Circuitry of a Vibration Monitoring System

FUEL GAUGE

The measurement of the quantity of fuel in the tanks of an aircraft fuel system is an essential requirement, and in conjunction with measurements of the rate at which the fuel flows to the engine or engines permits an aircraft to be flown at maximum efficiency.

There are two principle methods of indicating the quantity of fuel carried. Either the **Volume** (e.g. Gallons) or **Mass** (kg or lbs) are measured. The former is now only used on light aircraft as the **Mass** of the fuel is of more interest to the pilot. This assists the pilot in calculating the aircraft's 'all-up-weight' and also gives a better indication of the energy that can be released by the fuel. One pound of fuel has the same number of energy molecules regardless of temperature and volume.

The simplest form of volume indication is a float system. Early aircraft had a float which sat on the level of fuel. Attached to the float was a piece of wire that protruded out the top of the fuel tank. As the fuel level reduced so the wire disappeared from view. There have been many variations of this system. The most common of these is where the float moves to reposition a wiper on a variable resistor which alters the current to an indicator moving a pointer over a scale calibrated in volume. This is a DC powered system. (Figure 39 .19)

The disadvantage of this system is that the indication is not linear, and there is no provision for making adjustments for system accuracy. The gauge is set to be accurate at the low and empty positions. The system is also subject to errors whenever the aircraft manoeuvres and the attitude changes.

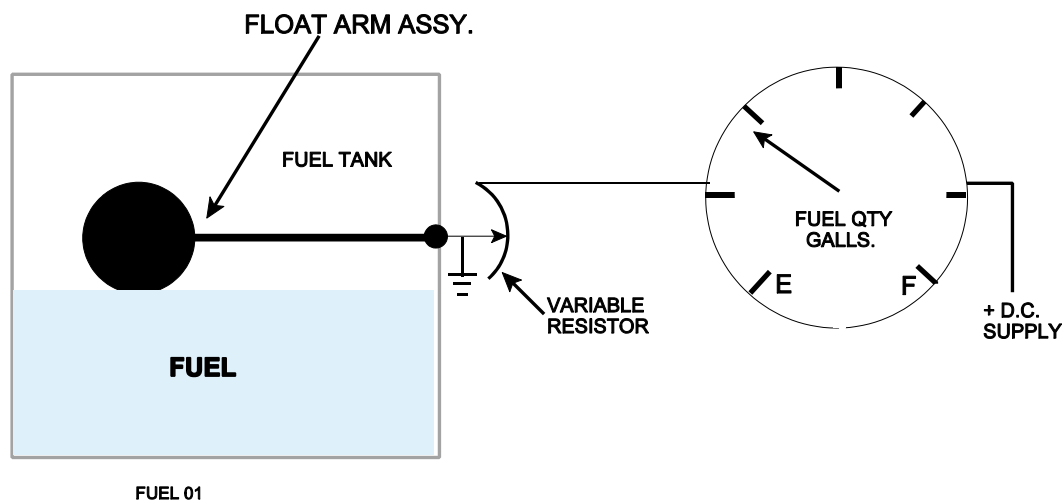

Figure 39.19 DC Float Type System

Capacitance Type Fuel Gauge System. In its basic form a capacitance system (Figure 39.20) consists of a variable AC capacitor located in the fuel tank (**Tank Unit** Figure 39.21) an amplifier and a indicator. This system will indicate volume without the errors of the float system. If a correction voltage due to change in volume or temperature change is fed to the circuit, **Mass** of fuel will be indicated. A tank unit consists of two concentric aluminium alloy tubes which are held apart by pairs of insulating pins. The electrical connections are insulated and the unit is insulated from the tank. Co-axial connectors are used throughout.

Incorporated in the system are **Reference units**, which improve indication errors that would occur if the permittivity of the fuel changes from its normal value. The reference unit is located on the lower end of a tank unit and is always totally submerged in the unusable fuel level in the tank.

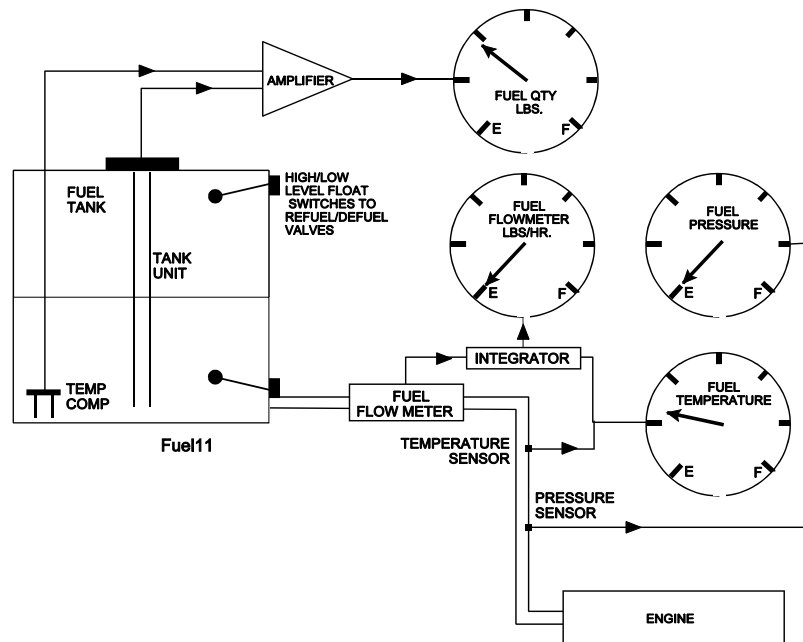

Figure 39.20

The principle of operation of the capacitance system is based on the use of fuel and air as the dielectric between parallel-plate capacitors of fixed area and a fixed distance between the plates. The only variable then being the ratio of fuel and air, which is determined by the quantity of fuel in the tank. Capacitance is measured in Farads, the standard unit being the Picofarad (10⁻¹² F). The capacitance depends on the following .

$$\text{Capacitance} = \text{Relative Permittivity} \times \frac{\text{Area of plates}}{\text{Distance between Plates}} \quad \text{or} \quad C = \epsilon_r \times \frac{A}{D}$$

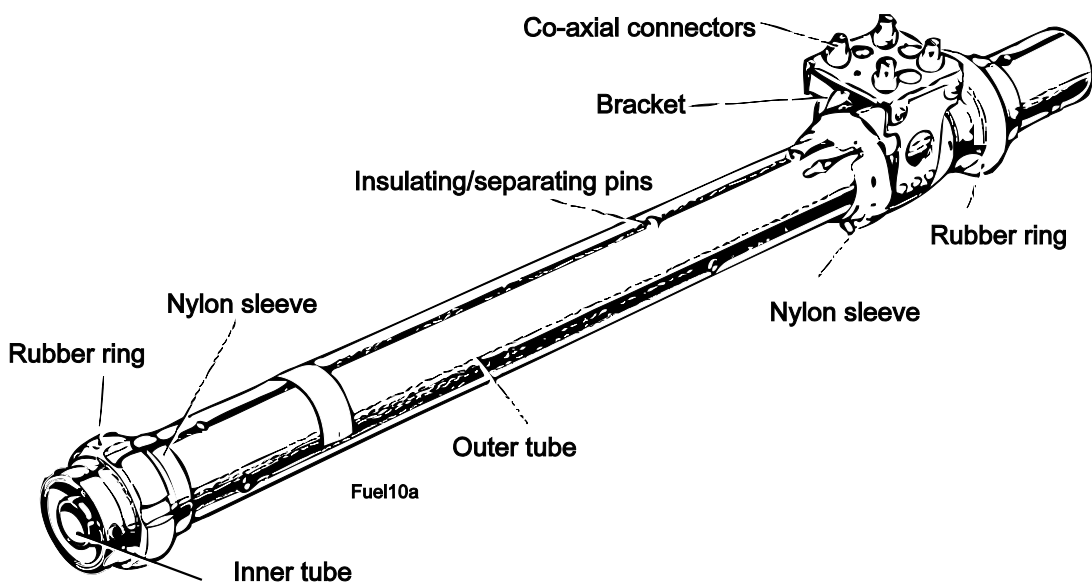

Figure 39.21 Capacitance Tank Unit

The **Relative Permittivity (Er)** is a number given as a ratio of the capacitance of a capacitor having a certain material as a dielectric to the capacitance of the same capacitor with a vacuum (or air) as its dielectric.

In an aircraft fuel system, the area of the plates and their distance apart remain constant, but the capacitance of the tank units will vary depending upon the level of fuel within the tanks.

The value of capacitance of a tank can be considered as two components. Ca (air) and Cf (fuel) and at any instance Tank Capacitance (Ct) =Ca + Cf. (Figure 39 22).

Typical Dielectric Values	
Material	Relative Permittivity
Impure water	0
Vacuum	1.0
Air	1.0006
Gasolene	1.95
Kerosene	2.10
Distilled Water	81.00

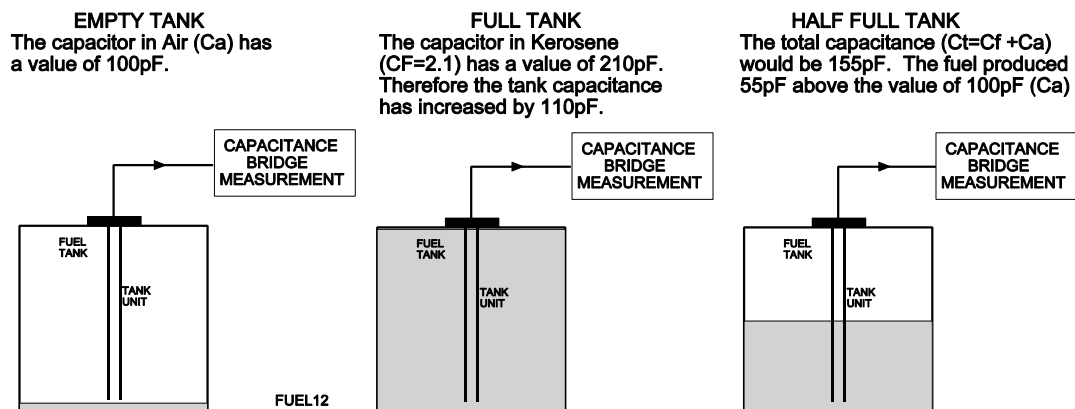

Figure 39.22

The pointer in the fuel quantity system measuring fuel by volume is directly related to:

- The change in fuel level.
- the ER- 1 value.

In an AC Capacitance circuit the Current is equal to the voltage over the capacitive reactance.

$$I (\text{current}) = \frac{V (\text{Voltage})}{X_c (\text{Capacitive Reactance})}$$

The capacitive reactance X_c is equal to $1/(2\pi f c)$. Since the voltage, frequency and 2π are constants, as the fuel level and capacitance change current in the circuit changes.

Changes in temperature of the fuel will affect its **density, volume and dielectric value (Er)**. A decrease in temperature would cause a decrease in volume, increase in density and increase in Er. The circuit is compensated for changes in temperature and can now indicate **Mass** of fuel which is of more value to the pilot.

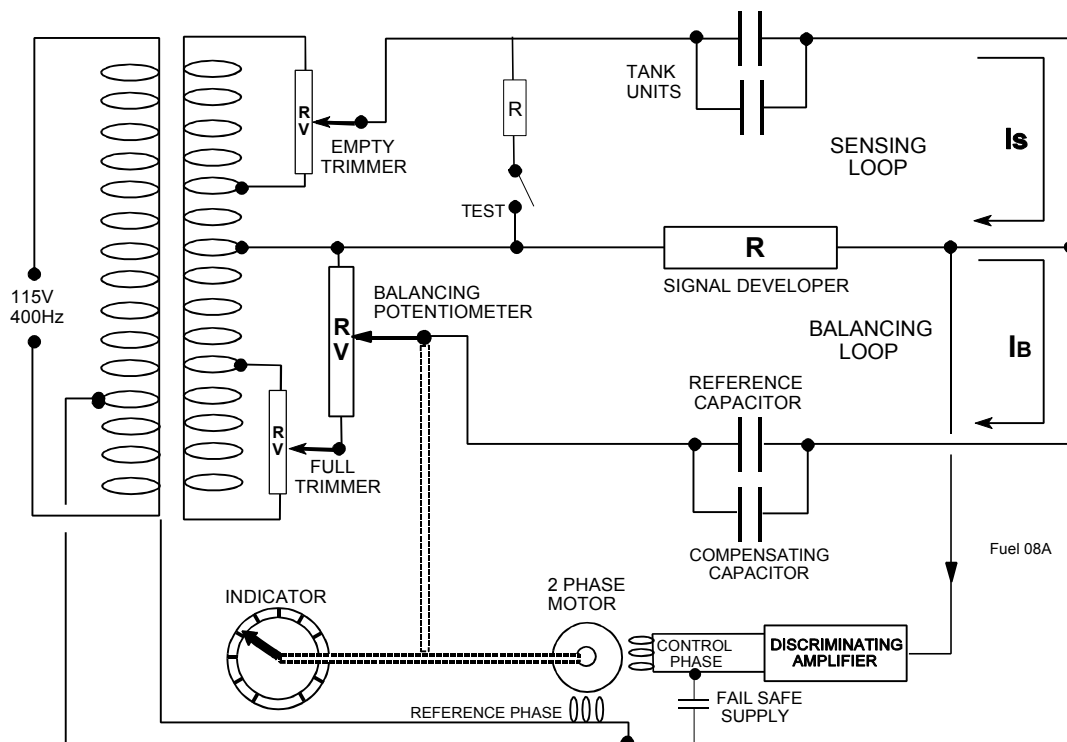

Figure 39.23 Capacitance Fuel Indicating Circuit

The system consists of a sensing and balancing loop circuit connected together by a signal developing resistor. When the fuel quantity is stable the current in the two loops are equal but anti-phase. No signal voltage is produced. As the fuel is consumed the capacitance and therefore the current in the sensing loop will decrease. The current in the balancing loop will then be greater and a signal voltage is produced across the signal developing resistor. The voltage is phase detected and amplified to drive an indicator. The system can be calibrated by the addition of trimming resistors.

As previously stated a more useful way of indicating fuel quantity is measurement by weight. For the calibration of gauges in terms of mass, an assumption is made that there is a constant relationship Er value and density (ρ) for a given sample of fuel at a given temperature. Temperature of course is not a constant and a **Compensating Capacitor** circuit is incorporated in the system. This is fitted to the reference unit. The system will now sense changes in **Specific Gravity (SG)** of the fuel and so indicate mass.

The indicating system can incorporate an additional indicator know as the '**Fuel Totaliser**' which will indicate the sum of all the tank gauges. In the event of failure, the system will fail safe and drive the indicator slowly to the zero position. A test circuit is incorporated that when selected will simulate the emptying of the tank. When the switch is released the pointer should return to its original position.

If water is present in the tanks it will cause errors with the indicating system. The capacitors in the sensing units are effectively shorted, and the indicator is driven beyond the full scale.

If the unusable fuel supply for any tank exceeds one gallon, or 5% of the tank capacity, whichever is greater, a **Red Arc** must be marked on its indicator extending from the calibrated zero reading to the lowest reading obtainable in flight.

As well as the quantity of fuel measured, the rate of fuel consumed and the instantaneous rate of fuel flow can be shown. The **Fuel Flowmeter** can display volume flow or mass flow. Flow is proportional to the square root of pressure drop across an orifice. A simple flowmeter can be a adaption of a pressure gauge. This is used on many light piston engine injection systems. Most modern engines use an electrical sensor, which utilise the change in torque or speed of a turbine (impeller). Typical construction consists of a light alloy casting with guide vanes and an electrical 'pick off' coil. Inside the casting there is a helical vane impeller which has a magnet embedded in it. When the impeller rotates due to fuel flow, the pick off coils will have a sinusoidal signal induced in it, at a frequency proportional to the speed of the rotor, which is proportional to the rate of volume flow. To measure mass flow the signal is corrected for temperature. (Figure 39.24)

The total consumption is obtained by integrating the rate of fuel consumption over time, this time is one hour. Units used for volume flow are **Gallons** and for mass flow **Pounds** or **Kilogrammes**. A flow meter that displays fuel consumed as well as fuel flow is broadly defined as a **Integrated** Flowmeter. The flow meter is located in the **High Pressure** fuel line to the fuel spray nozzles (burners).

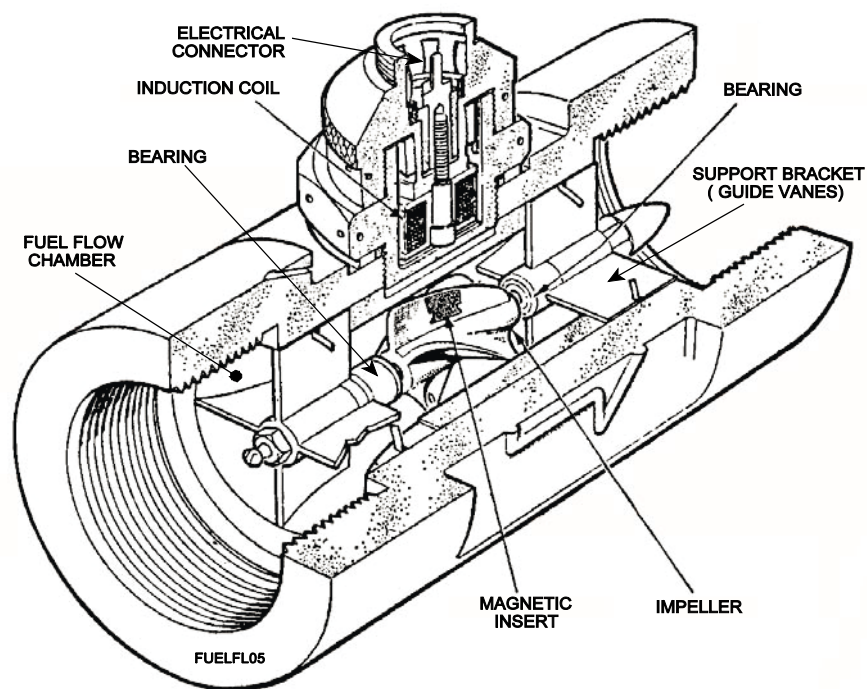

Figure 39.24 A typical Fuel Flowmeter

REMOTE (SIGNAL) TRANSMISSION SYSTEM

To control an aircraft system may require the movement of a valve, flap or lever on the engine, the pilot may need to know the position of the control. Early systems had **Mechanical Feedback** to a position indicator in the flight deck. Most of the aircraft flying today employ remote indicating systems that can be either D.C or A.C operated. Whichever system is used each data transmission system employs a **Transmitter** located at the source to be measured and a **Receiver**, which acts on the information received.

The D.C. systems are called **Desynn** indicators. The desynn system is available in 24 or 12v aircraft systems. The indicating accuracy is approximately 2.5%, which is not good by modern standards. The desynn is an old British design and will only be found on British built aircraft. This system may take one of three forms, namely; **Rotary Motion, Linear Motion** and **Slab - Desynn**. The rotary motion arrangement may be considered as the basic system from which the others have been developed. These transmitter's can be used to indicate contents, pressures or movement. The system consists of a Transmitter, Transmission Leads and a Receiver.

The transmitter consist of a wiper arm which is supplied with D.C. and is positioned on a toroidal resistance. Three pick-offs are taken from the resistance positioned at 120 degrees apart. The current which flows from each pick-off is proportional to the relative position of the wiper arm on the toroidal resistance. The receiver consist of a magnetised pointer and three coils positioned 120 degrees to each other. Each coil is in series with one of the pick-offs on the toroidal resistance in the transmitter. The flow of current through each coil is therefore relative to the position of the wiper arm on the toroidal resistance. Each coil will produce a magnetic field, the strength and polarity of the field is dependant upon the amount and direction of the current flowing through the coil. The three magnetic fields will combine to form one resultant field. The magnetised pointer will align itself with this resultant field and thus the receiver can be calibrated to remotely reproduce the position of the wiper arm on the toroidal resistance. See Figure 39.25

The desynn system has inherent errors caused by the wiper arm being in physical contact with the resistor, this causes inaccuracies due to friction and carbon contamination. The scale is also non-linear.

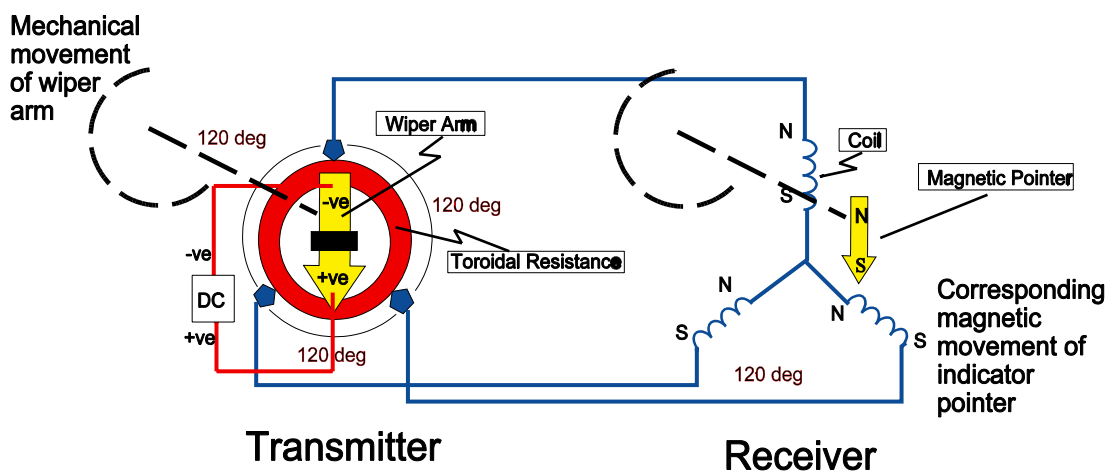

Figure 39.25 Desynn Data Transmission System

The AC systems are collectively called **Synchros** , and work on the principle of a variable transformer. The AC voltage used is 26 volt. In the illustration below (Figure 39.26), as the input shaft is rotated the induce signal in the secondary winding can be varied in two ways:

- The magnitude of the induced signal will vary in direct relationship to the angle between the primary and secondary windings.
- The phasing of the induced signal will vary twice for one complete rotation of the primary winding.

The synchro device works on the principle described above, but to obtain more precise information it is necessary to modify the transformer design so that we have one rotor coil (primary), and three stator coils to produce the output (secondaries). It is much more accurate than the desynn system. For this reason it is used when precise position information is required.

The transmitter consists of three secondary coils positioned at 120 degrees to each other and a fourth primary coil placed within them. An A.C. current is passed through the primary coil which produces an alternating magnetic field. This alternating magnetic field causes an EMF to be induced in the three secondary coils. The value of the EMF induced in any one of the secondary coils is dependent upon its relative position to the primary coil.

The receiver also consists of three secondary coils positioned at 120 degrees to each other and a fourth primary coil placed within them. The receiver secondary coils are in series with the secondary coils of the transmitter. This closed circuit causes a current to flow through the coils.

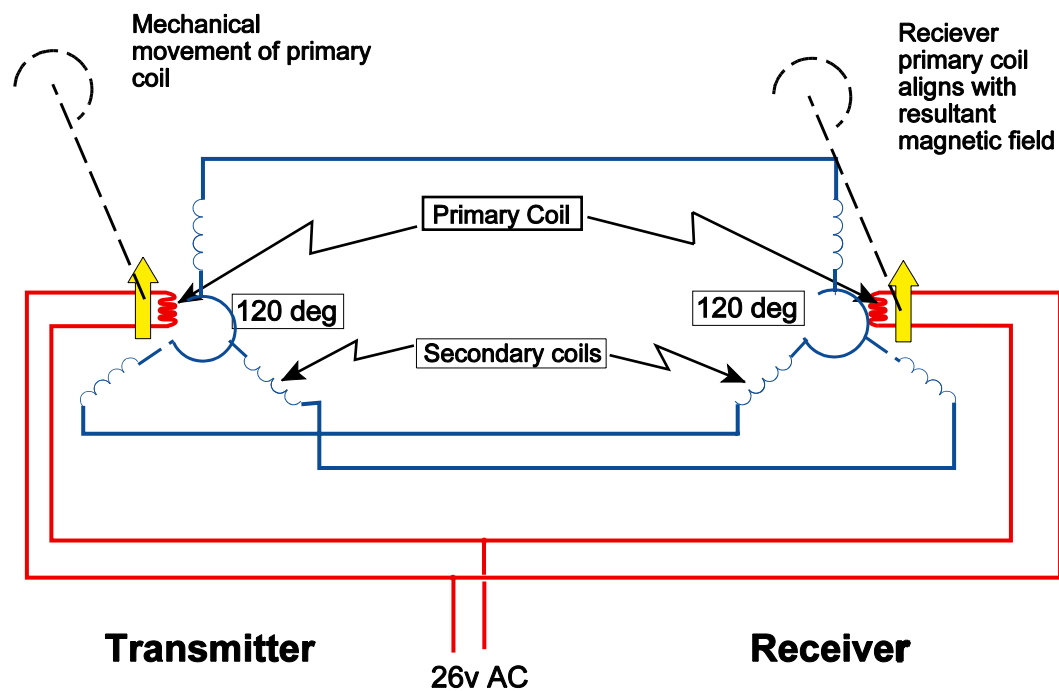

Figure 39.26 AC Synchro System

The value of the current is proportional to the value of the induced EMF in the associated transmitter secondary coil. The three magnetic fields produced by the secondary coils combine to produce a resultant field. The receiver primary coil is in series with the transmitter primary coil. This causes the receiver primary coil to align itself in the resultant magnetic field produced by the receiver secondary coils and thus remotely reproduce the position of the input.

FLIGHT HOUR METER

Some aircraft indicate and record usage of the engines in flight. This information is used to determine engine condition. The flight hour meter can be coupled to an airborne sensor which becomes active at certain speeds.

CHAPTER FORTY
ELECTRONIC INSTRUMENTATION

Contents

ELECTRONIC INSTRUMENTS FOR ENGINE AND AIRFRAME SYSTEMS CONTROL575

EICAS575

DISPLAY UNITS576

DISPLAY MODES578

OPERATIONAL MODE578

STATUS MODE578

MAINTENANCE MODE578

DISPLAY SELECT PANEL578

ALERT MESSAGES580

DISPLAY UNIT FAILURE581

DISPLAY SELECT PANEL FAILURE582

STANDBY ENGINE INDICATOR582

MAINTENANCE CONTROL PANEL583

ELECTRONIC CENTRALIZED AIRCRAFT MONITORING (ECAM).585

DISPLAY UNITS586

DISPLAY MODES586

THE FLIGHT PHASE-RELATED MODE587

ADVISORY (MODE AND STATUS)587

FAILURE-RELATED MODE588

THE FOURTH MODE (MANUAL), THE AIRCRAFT SYSTEM DISPLAY MODE . . .589

THE 'ECAM' CONTROL PANEL589

SYSTEM TESTING591

QUESTIONS593

ANSWERS596

ELECTRONIC INSTRUMENTS FOR ENGINE AND AIRFRAME SYSTEMS CONTROL

The display of the parameters associated with engine performance and airframe systems control by means of Cathode Ray Tube type display units has, like those of flight instrument systems, become a standard feature of many types of aircraft.

The display units form part of two principal systems designated as Engine Indicating and Crew Alerting System (EICAS), and Electronic Centralized Aircraft Monitoring (ECAM) system. These systems were first introduced in Boeing 757 and 767 aircraft and the Airbus A310 respectively.

At the time of their introduction there were differing views on the approach to such operating factors as flight deck layouts and crews' controlling functions, the extent to which normal, alerting and warning information should be displayed, and in particular, whether engine operating data was required to be displayed for the whole of a flight, or only at various phases.

In respect of EICAS, engine operating data is displayed on its CRT units, thereby eliminating the need for traditional instruments.

This data, as well as that relevant to other systems, is not necessarily always on display but in the event of malfunctions occurring at any time, the flight crew's attention is drawn to them by an automatic display of messages in the appropriate colours.

The ECAM system, on the other hand, displays systems' operation in checklist and schematic form, and as this was a concept based on the view that engine data needed to be displayed during the whole of a flight, traditional instruments were retained in the Airbus A310.

It is of interest to note, however, that in subsequent types produced by this manufacturer, e.g. A320, the ECAM system is developed to include the display of engine data in one of its display units.

EICAS

The basic EICAS system comprises two display units, a control panel, and two computers supplied with analog and digital signals from engine and system sensors as shown in the schematic functional diagram of Figure 2.1.

The computers are designated 'Left' and 'Right', and only one is in control at a time; the other is on 'standby', and in the event of failure it may be switched in either manually or automatically. Operating in conjunction with the EICAS system are discrete caution and warning lights, standby engine indicators and a remotely-located panel for selecting maintenance data displays.

The system provides the flight crew with information on primary engine parameters (full-time), with secondary engine parameters and advisory / caution / warning alert messages displayed as required.

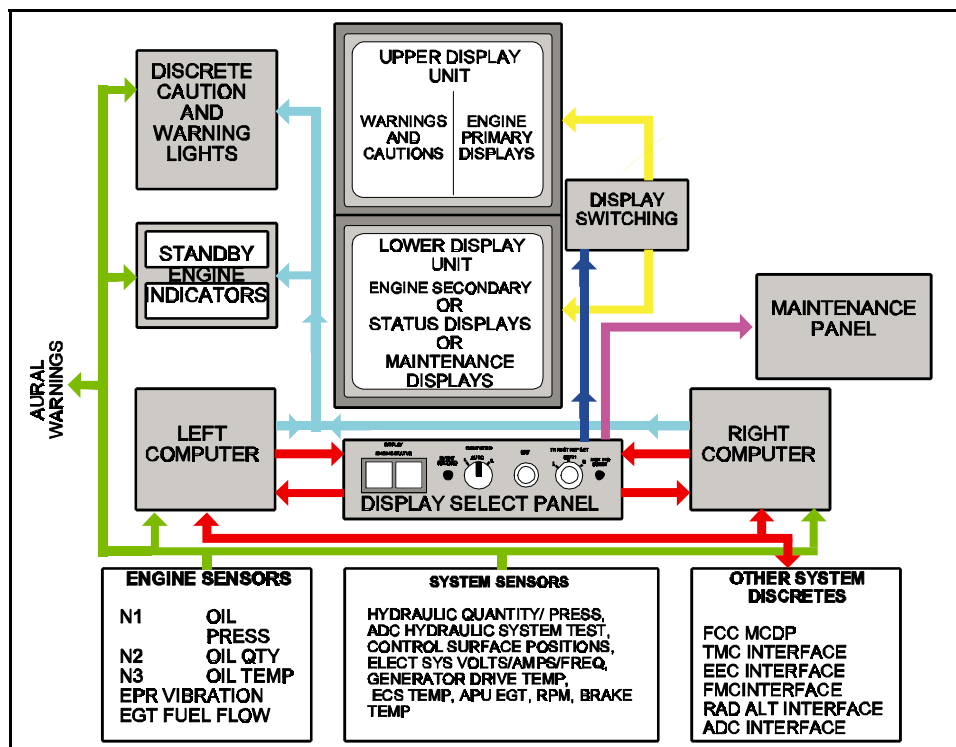

Figure 40.1 The EICAS Functional Diagram

DISPLAY UNITS

The display units provide a wide variety of information relevant to engine operation, and operation of other automated systems, and they utilize colour shadow mask CRTs and associated card modules whose functions are identical to those of the EFIS units. The units are mounted one above the other as shown in Figure 40.2.

The **upper unit** displays the primary engine parameters, N1 speed, EGT, and warning and caution messages.

In some cases this unit can also display EPR, depending on the type of engines installed and on the methods used to process data by the thrust management control system.

The **lower unit** displays secondary engine parameters, i.e. N2 speed, fuel flow, oil quantity, pressure and temperature, and engine vibration. In addition, the status of non-engine systems, e.g. flight control surface positions, hydraulic system, APU, etc., can also be displayed together with aircraft configuration and maintenance data.

The rows of 'V's shown on the upper display unit only appear when secondary information is being displayed on the lower unit.

Seven colours are produced by the CRTs and they are used as follows:

White	All scales, normal operating range of pointers, digital readouts.
Red	Warning messages, maximum operating limit marks on scales, and digital readouts.
Green	Thrust mode readout and selected EPR / N1 speed marks or target cursors.
Blue	Testing of system only.
Yellow	Caution and advisory messages, caution limit marks on scales, digital readouts.
Magenta	During in-flight engine starting, and for cross-bleed messages.
Cyan	Names of all parameters being measured (e.g. N1 oil pressure, TAT etc. and status marks or cues.

The displays are selected according to an appropriate display selection mode.

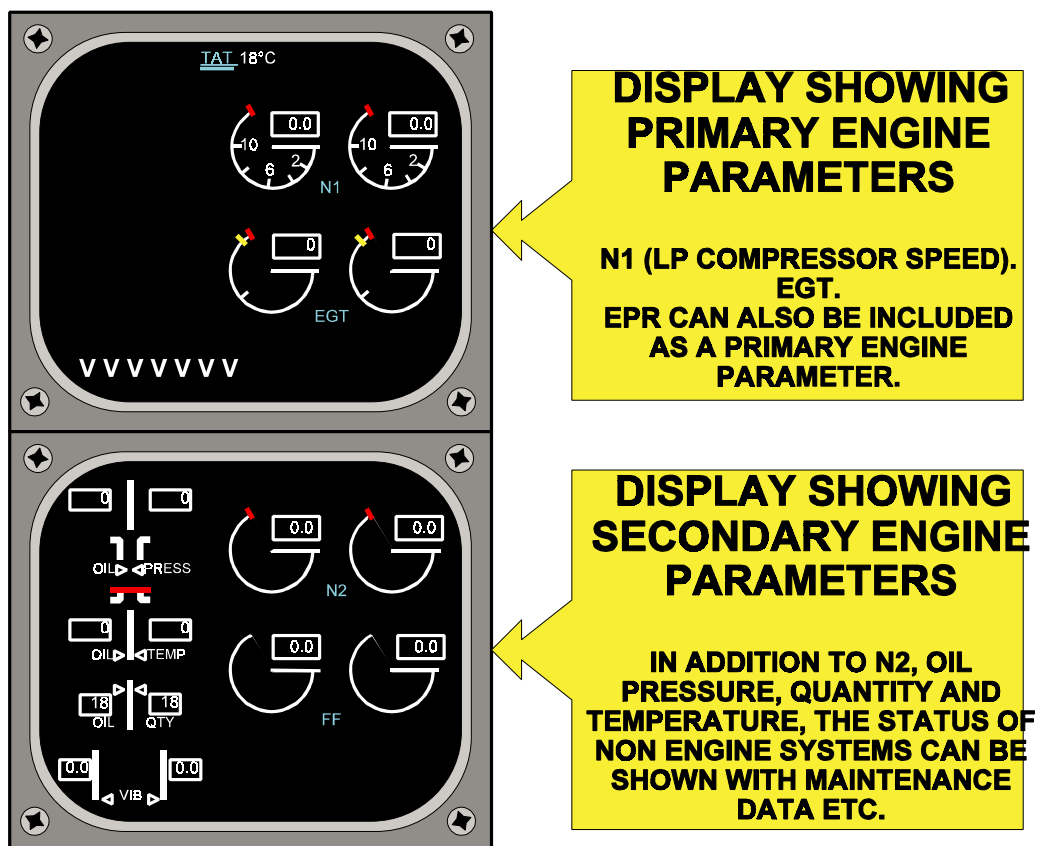

Figure 40.2 EICAS Engine Data Displays

DISPLAY MODES

EICAS is designed to categorize displays and alerts according to function and usage, and for this purpose there are three modes of displaying information: (i) **operational**, (ii) **status** and (iii) **maintenance**.

Modes (i) and (ii) are selected by the flight crew on the display select panel, while mode (iii) is selected on the maintenance panel which is for the use of ground engineering staff only.

OPERATIONAL MODE

The **operational mode** displays the engine operating information and any alerts required to be actioned by the crew in flight.

Normally only the upper display unit presents information, the lower one remains blank and can be selected to display secondary information as and when required.

STATUS MODE

When selected, the **status mode** displays data to determine the dispatch readiness of an aircraft, and is closely associated with details contained in an aircraft's Minimum Equipment List.

The display shows positions of the flight control surfaces in the form of pointers registered against vertical scales, selected sub-system parameters, and equipment status messages on the lower display unit. Selection is normally done on the ground either as part of pre-flight checks of dispatch items, or prior to shut-down of electrical power to aid the flight crew in making entries in the aircraft's Technical Log.

MAINTENANCE MODE

This mode provides maintenance engineers with information in five different display formats to aid them in trouble-shooting and verification testing of the major sub-systems.

The displays, which are presented on the lower display unit, are not available in flight.

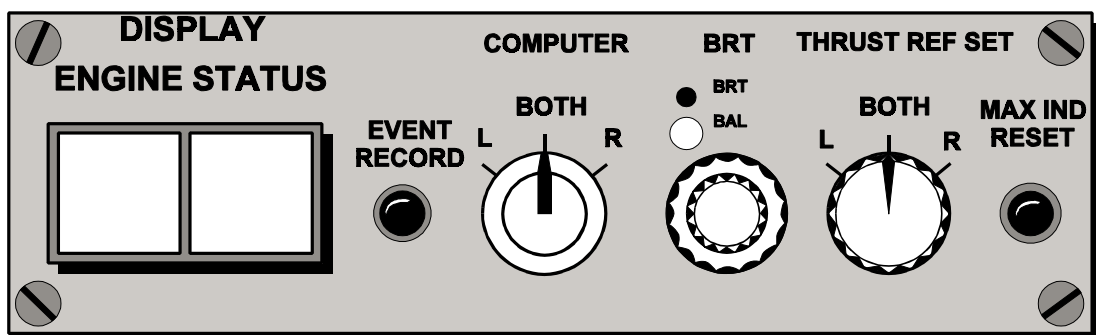

Figure 40.3 EICAS Display Select Panel

DISPLAY SELECT PANEL

This panel, as indicated in Figure 40.3, permits control of EICAS functions and displays and can be used both in flight and on the ground. It is normally located on the centre pedestal of an aircraft's flight deck, and its controls are as follows:

- **Engine Display Switch.** This is of the momentary-push type for removing or presenting the display of secondary information on the lower display unit.

- **Status Display Switch.** Also of the momentary-push type, this is used to display the status mode information referred to earlier, on the lower display unit. The display is known as a 'status page', an example of which is shown in Figure 40.4.
- **Event Record Switch.** This is of the momentary-push type and is used in the air or on the ground, to activate the recording of fault data relevant to the environment control system, electrical power, hydraulic system, performance and APU. Normally if any malfunction occurs in a system, it is recorded automatically (called an 'auto event') and stored in a non-volatile memory of the EICAS computer. The push switch also enables the flight crew to record a suspected malfunction for storage, and this is called a 'manual event'. The relevant data can only be retrieved from memory and displayed when the aircraft is on the ground and by operating switches on the maintenance control panel.

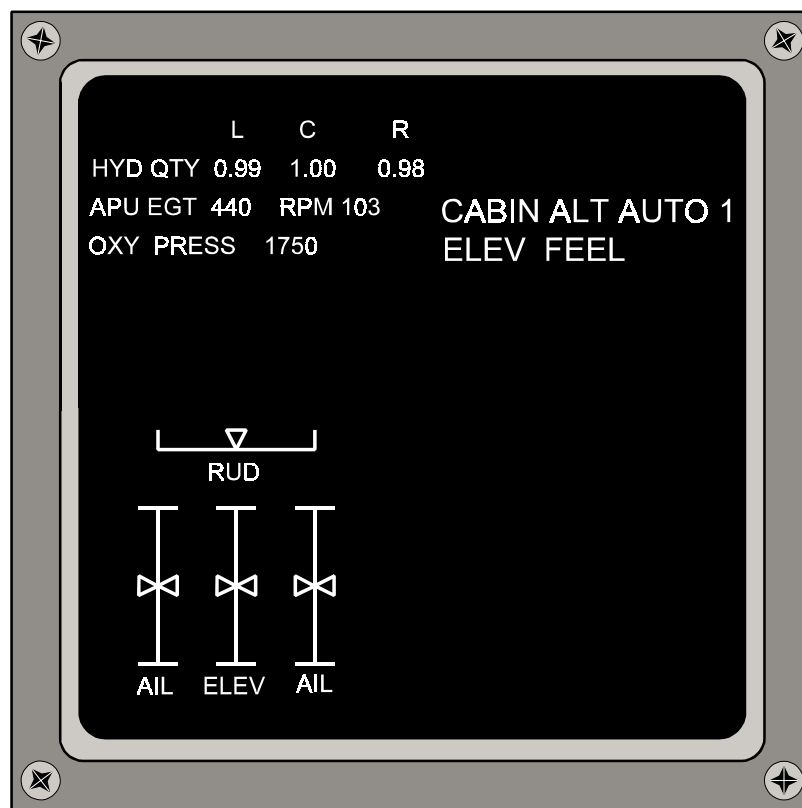

Figure 40.4 Status Mode Display

- **Computer Select Switch.** In the 'AUTO' position it selects the left, or primary, computer and automatically switches to the other computer in the event of failure. The other positions are for the manual selection of left or right computers.
- **Displays Brightness Control.** The inner knob controls the intensity of the displays, and the outer knob controls brightness balance between displays.
- **Thrust Reference Set Switch.** Pulling and rotating the inner knob positions the reference cursor on the thrust indicator display (either EPR or N1) for the engine(s) selected by the outer knob.

- **Maximum Indicator Reset Switch.** If any one of the measured parameters e.g. oil pressure, EGT, should exceed normal operating limits, this will be automatically alerted on the display units. The purpose of the reset switch is to clear the alerts from the display when the excess limits no longer exist.

ALERT MESSAGES

The system continuously monitors a large number of inputs (typically over 400) from engine and airframe systems' sensors and will detect any malfunctioning of systems.

If this should occur, then appropriate messages are generated and displayed on the upper display unit in a sequence corresponding to the level of urgency of action to be taken.

Up to 11 messages can be displayed, and at the following levels:

Level A - Warning requiring immediate corrective action. They are displayed in red. Master warning lights are also illuminated, and aural warnings (eg fire bell) from a central warning system are given.

Level B - Cautions requiring immediate crew awareness and possible action. They are displayed in amber, and also by message caution lights. An aural tone is also repeated twice.

Level C - Advisories requiring crew awareness. Also displayed in amber. No caution lights or aural tones are associated with this level.

The messages appear on the top line at the left of the display screen as shown in Figure 40.5.

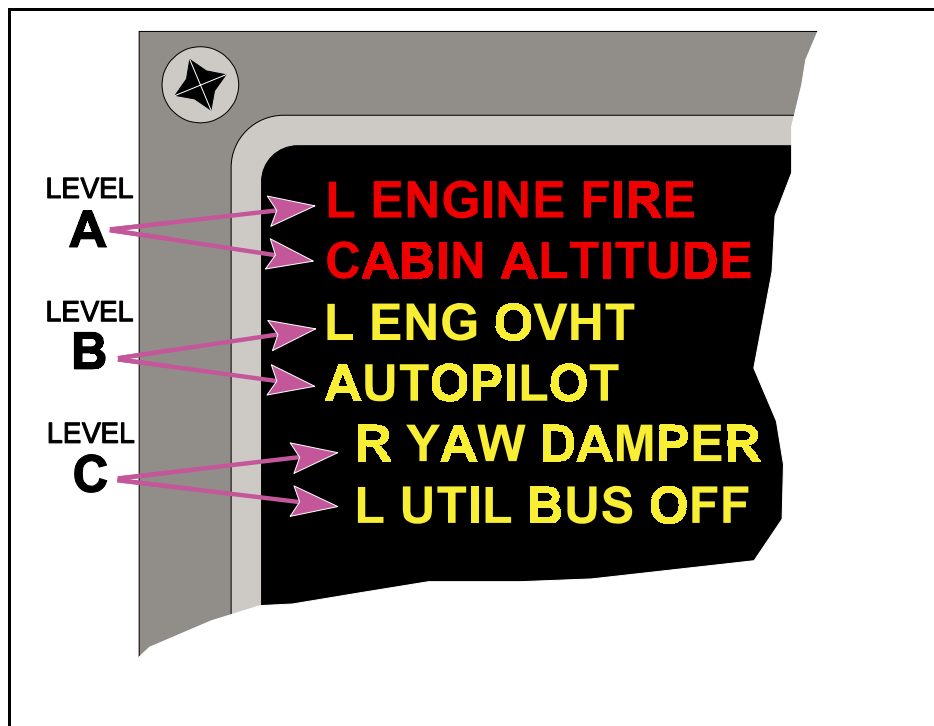

Figure 40.5 Alert Message Levels

In order to differentiate between a caution and an advisory, the latter is always indented one space to the right.

The master warning and caution lights are located adjacent to the display units together with a 'CANCEL' switch and a 'RECALL' switch. Pushing the 'CANCEL' switch removes only the caution and advisory messages from the display; the warning messages cannot be cancelled. The 'RECALL' switch is used to bring back the caution and advisory messages into the display. At the same time, the word 'RECALL' appears at the bottom of the display.

A message is automatically removed from the display when the associated condition no longer exists. In this case, messages which appear below the deleted one each move up a line.

When a new fault occurs, its associated message is inserted on the appropriate line of the display. This may cause older messages to move down one line. For example, a new caution message would cause all existing caution and advisory messages to move down one line.

If there are more messages than can be displayed at one time, the whole list forms what is termed a 'page', and the lowest message is removed and a page number appears in white on the lower right side of the list.

If there is an additional page of messages it can be displayed by pushing the 'Cancel' switch. Warning messages are carried over from the previous page.

DISPLAY UNIT FAILURE

If the lower display unit should fail when secondary information is being displayed on it, an amber alert message appears at the top left of the upper display unit, and the information is transferred to it as shown in Figure 40.6.

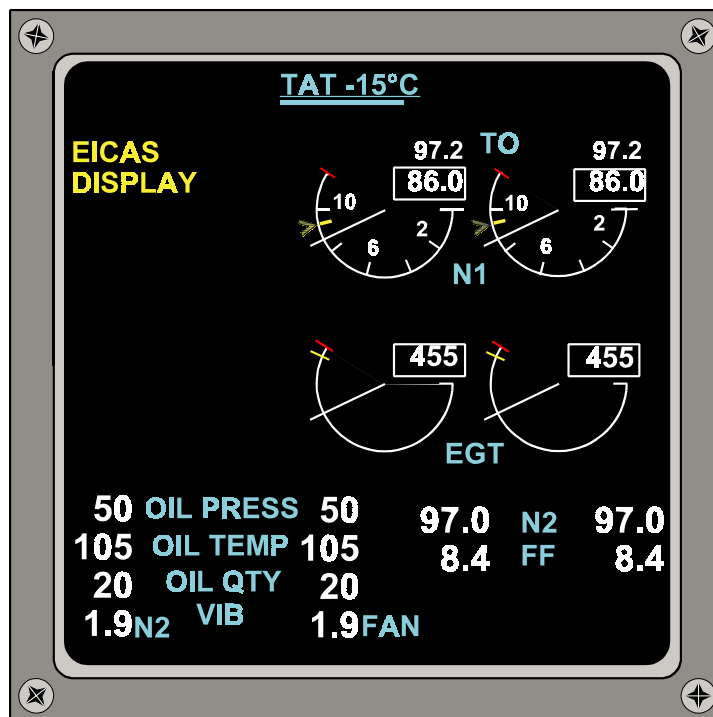

Figure 40.6 The 'Compact Format' Display

The format of this display is referred to as 'compact', and it may be removed by pressing the 'ENGINE' switch on the display select panel. Failure of a display unit causes the function of the panel 'STATUS' switch to be inhibited so that the status page format cannot be displayed.

DISPLAY SELECT PANEL FAILURE

If this panel fails the advisory message 'EICAS CONTROL PANEL' appears at the top left of the upper display unit together with the primary information, and the secondary information automatically appears on the lower display unit. The 'CANCEL / RECALL' switches do not operate in this failure condition.

STANDBY ENGINE INDICATOR

This indicator provides primary engine information in the event that a total loss of EICAS displays occurs.

As shown in Figure 40.7, the information relates to N1 and N2 speeds and EGT and the displays are of the LCD type. Operating limit values are also displayed.

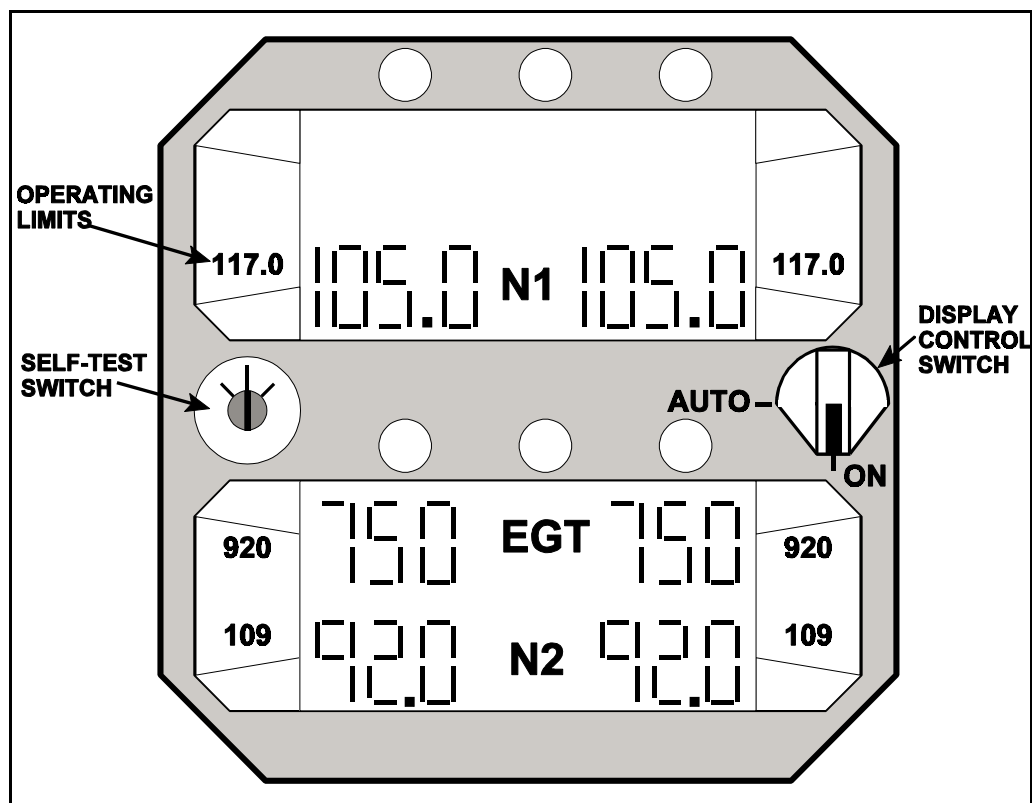

Figure 40.7 The Standby Engine Indicator

The display control switch has two positions, 'ON' and 'AUTO'. In the 'ON' position the displays are permanently on. In the 'AUTO' position the internal circuits are functional, but the displays will be automatically presented when the EICAS displays are lost due to failure of both display units or both computers.

The test switch has three positions, and is spring-loaded to a centre off position. It is screwdriver-operated and when turned to the left or right, it changes over power supply units within the indicator to ensure that they each provide power for the displays. The test can be performed with the display control switch in any position.

MAINTENANCE CONTROL PANEL

The maintenance control panel is for use by maintenance engineers for the purpose of displaying maintenance data stored in system computer memories during flight or ground operations. The layout of the panel and the principal functions of each of the controls are shown in Figure 40.8.

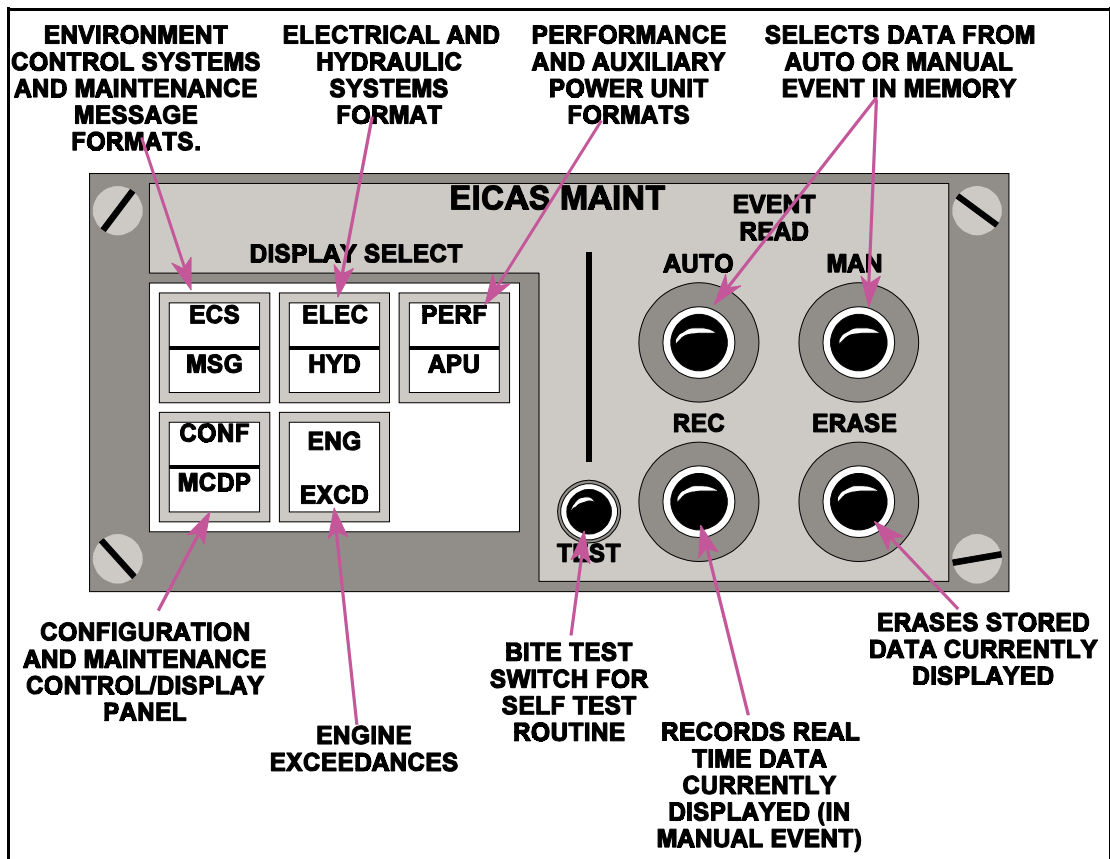

Figure 40.8 The Maintenance Control Panel

The five display select switches are of the momentary-push type, and as each one is activated, a corresponding maintenance display page appears on the lower display unit screen. The pages are listed together with two example displays in Figure 40.9.

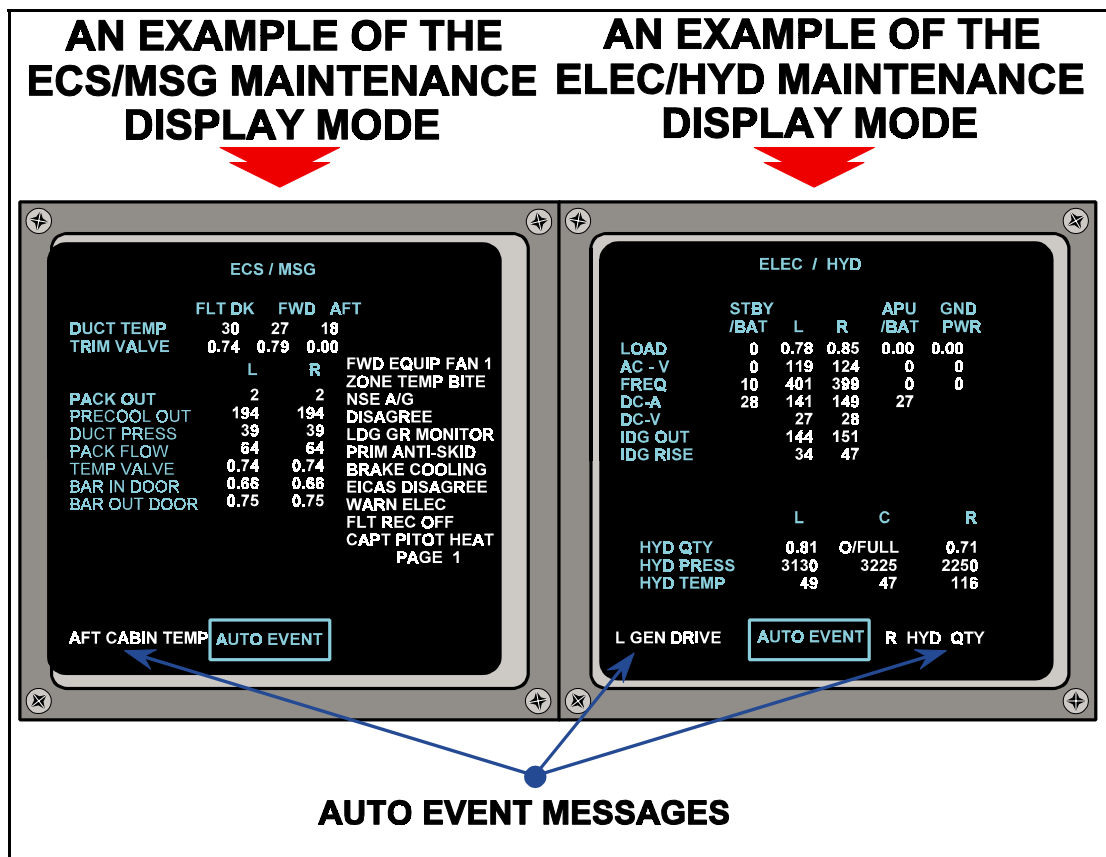

Figure 40.9 Examples of Maintenance Mode Displays

The upper display unit displays data in the 'compact' format (see Figure 40.6.) with the message 'PARKING BRAKE' in the top left of the screen.

System failures which have occurred in flight and have been automatically recorded ('auto event') in computer memory, and also data entered as a 'manual event', can be retrieved for display by means of the 'event record' switch on the panel. A self-test of the whole system, which can only be activated when an aircraft is on the ground and the parking brake set, is performed by means of the 'TEST' switch on the maintenance control panel.

When the switch is momentarily pressed, a complete test routine of the system, including interface and all signal-processing circuits, and power supplies, is automatically performed. For this purpose an initial test pattern is displayed on both display units with a message in white to indicate the system being tested i.e. 'L or R EICAS' depending on the setting of the selector switch on the display select panel.

During the test, the master caution and warning lights and aural devices are activated, and the standby engine indicator is turned on if its display control switch is at 'AUTO'.

The message 'TEST IN PROGRESS' appears at the top left of display unit screens and remains in view while testing is in progress.

On satisfactory completion of the test, the message 'TEST OK' will appear.

If a computer or display unit failure has occurred, the message 'TEST FAIL' will appear followed by messages indicating which of the units has failed.

A test may be terminated by pressing the 'TEST' switch a second time or, if it is safe to do so, by releasing an aircraft's parking brake.

Test termination will allow the display units to revert to showing their normal primary and secondary information displays.

ELECTRONIC CENTRALIZED AIRCRAFT MONITORING (ECAM)

The units comprising this system, and as originally developed for the Airbus A310, are shown in the functional diagram of Figure 40.10.

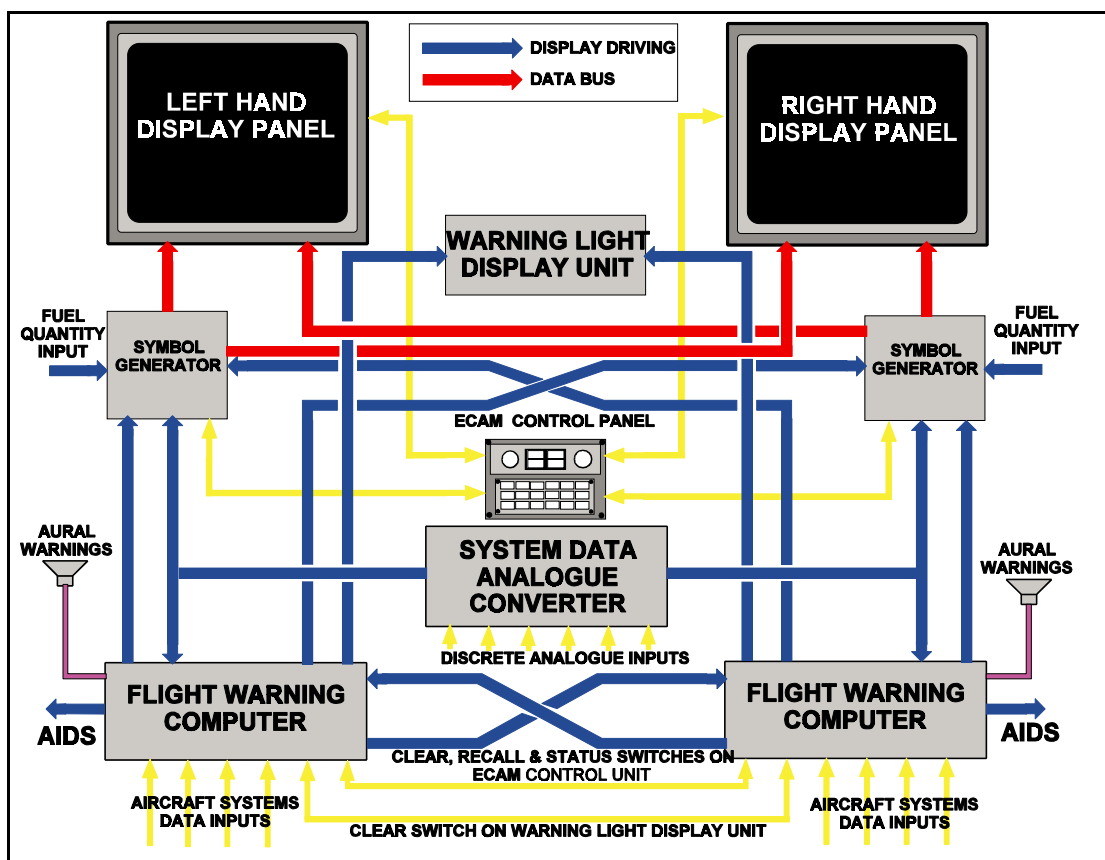

Figure 40.10. ECAM System Functional Diagram.

As far as the processing and display of information are concerned, the ECAM system differs significantly from EICAS in that data relates essentially to the primary systems of the aircraft, and is displayed in check-list and pictorial or synoptic format.

Engine operating data is displayed by conventional types of instruments as noted in the introduction to this chapter. Other differences relate to display locations and selection of system operating modes.

DISPLAY UNITS

These units may be mounted side-by-side; the left-hand unit is dedicated to information on the status of systems, warnings and corrective action in a sequenced check-list format, while the right-hand unit is dedicated to associated information in pictorial or synoptic format.

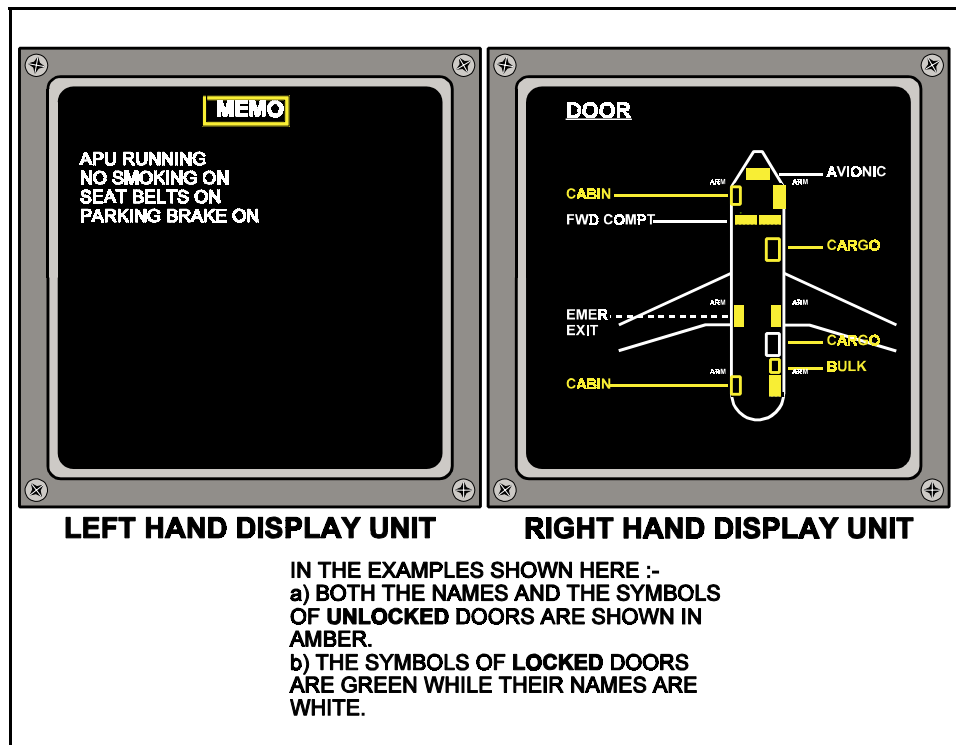

Figure 40.11 Pre-Flight Phase-Related Mode Display

DISPLAY MODES

There are four display modes, three of which are automatically selected and referred to as:

- Flight Phase-related
- Advisory (mode and status)
- Failure-related modes.

The fourth mode is manual

- Aircraft System Display.

THE FLIGHT PHASE-RELATED MODE

In normal operation the automatic 'flight phase-related mode' is used, and in this case the displays are appropriate to the current phase of aircraft operation, i.e. pre-flight, take-off, climb, cruise, descent, approach, and after landing.

An example of a pre-flight phase is shown in Figure 40.11, the left-hand display unit displays an advisory memo mode, and the right-hand unit displays a diagram of the aircraft's fuselage, doors, and arming of the escape slides deployment system.

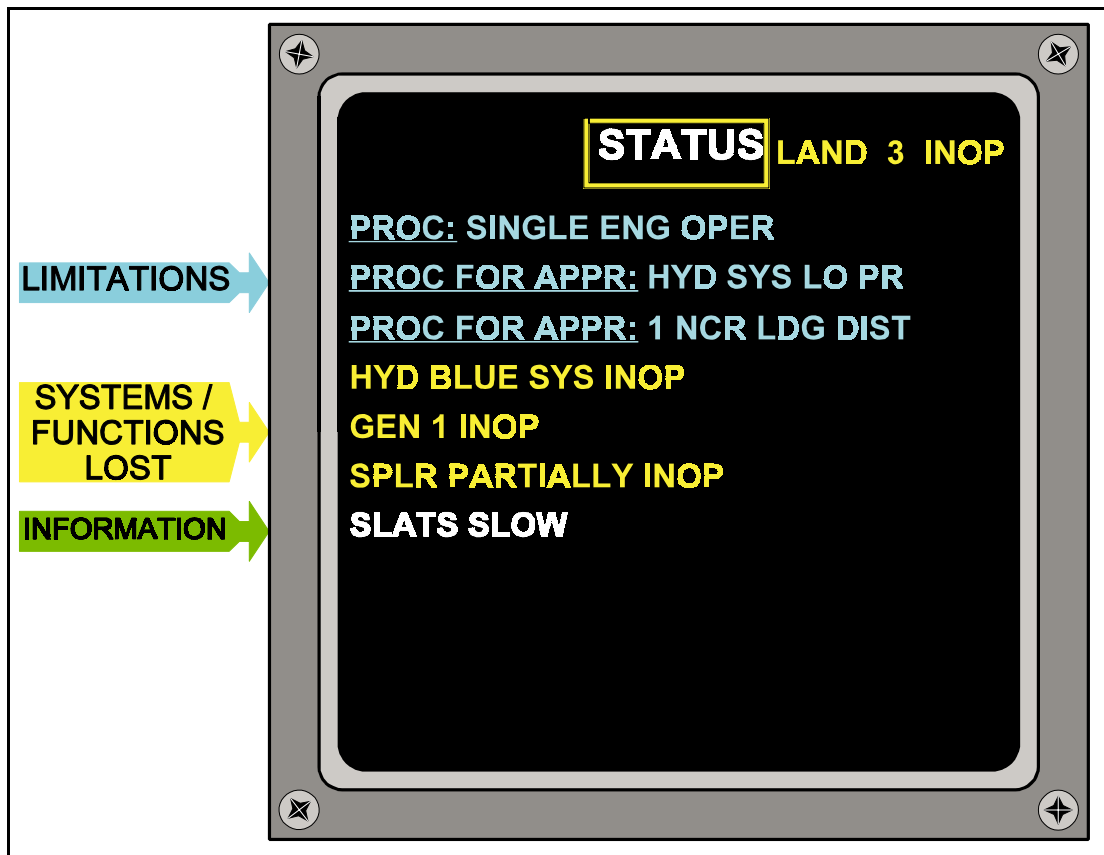

Figure 40.12 An Example of the Status Display

ADVISORY (MODE AND STATUS)

Status messages, which are also displayed on the left-hand display unit, provide the flight crew with an operational summary of the aircraft's condition, possible downgrading of autoland capability, and as far as possible, indications of the aircraft status following all failures except those that do not affect the flight. The contents of an example display are shown in Figure 40.12.

FAILURE-RELATED MODE

The failure-related mode takes precedence over the other two automatic modes and the manual mode.

An example of a display associated with this mode is shown in Figure 40.13.

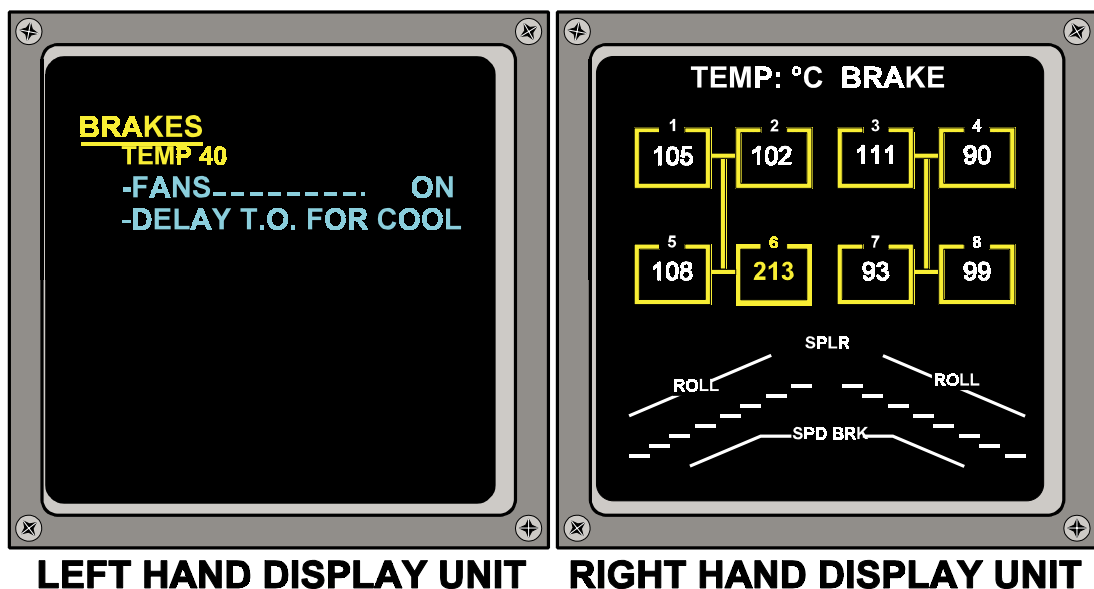

Figure 40.13 The Failure-Related Mode Display

In this case, while taxiing out for take-off, the temperature of the brake unit on the rear right wheel of the left main landing gear bogie has become excessive.

A diagram of the wheel brake system is immediately displayed on the right-hand display unit, and simultaneously the left-hand unit displays corrective action to be taken by the flight crew. In addition, an aural warning is sounded, and a light (placarded 'L/G WHEEL') on a central warning light display panel is illuminated.

As the corrective action is carried out, the instructions on the left-hand display are replaced by a message in white confirming the result of the action. The diagram on the right-hand display unit is appropriately 'redrawn'. In the example above, the 'failure related mode' displaces warning relates to a single system, and by convention such warnings are signified by underlining the system title displayed.

In cases where a failure can affect other sub-systems, the title of the sub-system is shown 'boxed', as for instance in the display shown in Figure 40.14.

Warnings and the associated lights are cleared by means of 'CLEAR' push-button switches on either the ECAM control panel or a warning light display panel.

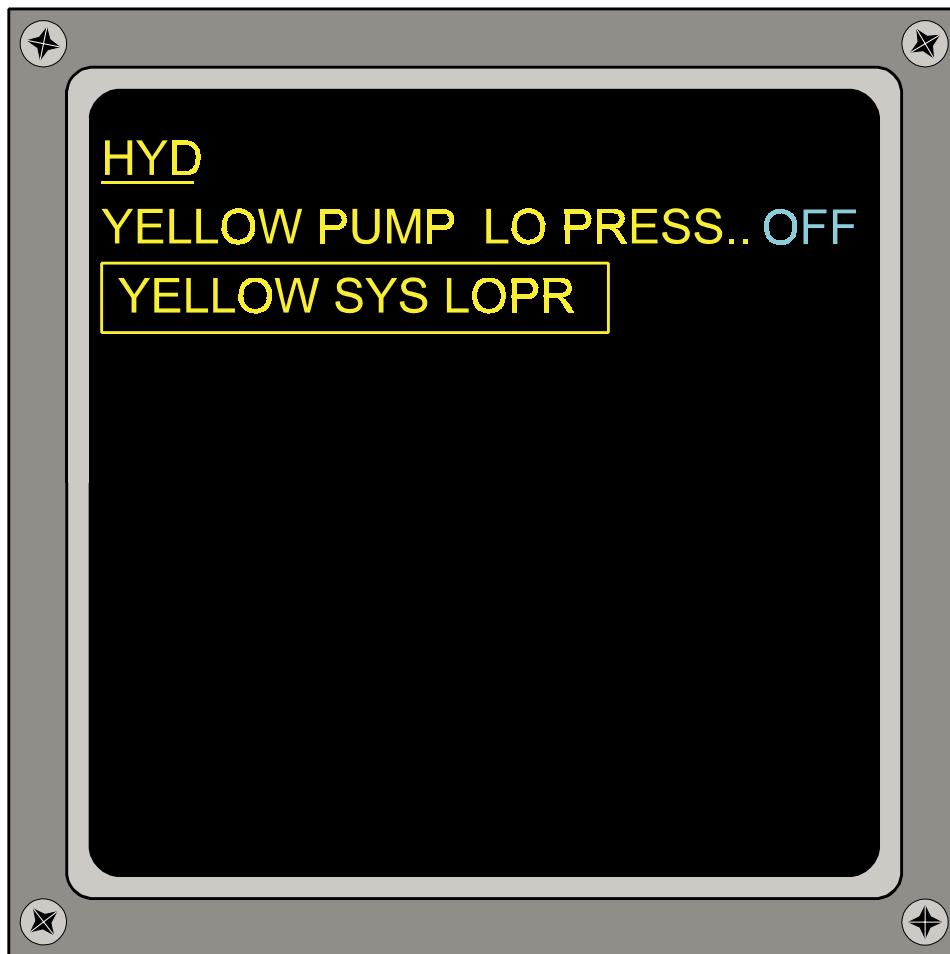

Figure 40.14 A Display Showing How a Failure Affects a Sub- System

THE FOURTH MODE (MANUAL), THE AIRCRAFT SYSTEM DISPLAY MODE

This mode permits the selection of diagrams related to any one of 12 of the aircraft's systems for routine checking, and also the selection of status messages provided no warnings have been triggered' for display. The selections are made by means of illuminated push-button switches on the system control panel.

THE 'ECAM' CONTROL PANEL

The layout of the 'ECAM' control panel is shown in Figure 40.15, all switches, with the exception of those for display control, are of the push-button, illuminated caption type.

SGU Selector Switches. These control the respective symbol generator units, and the lights are off in normal operation of the system. The 'FAULT' caption is illuminated amber if a failure is detected by an SGU's internal self-test circuit. Releasing a switch isolates the corresponding SGU, and causes the 'FAULT' caption to extinguish, and the 'OFF' caption to illuminate white.

Synoptic Display Switches. These permit individual selection of synoptic diagrams corresponding to each of 12 systems, and illuminate white when pressed. A display is automatically cancelled whenever a warning or advisory occurs.

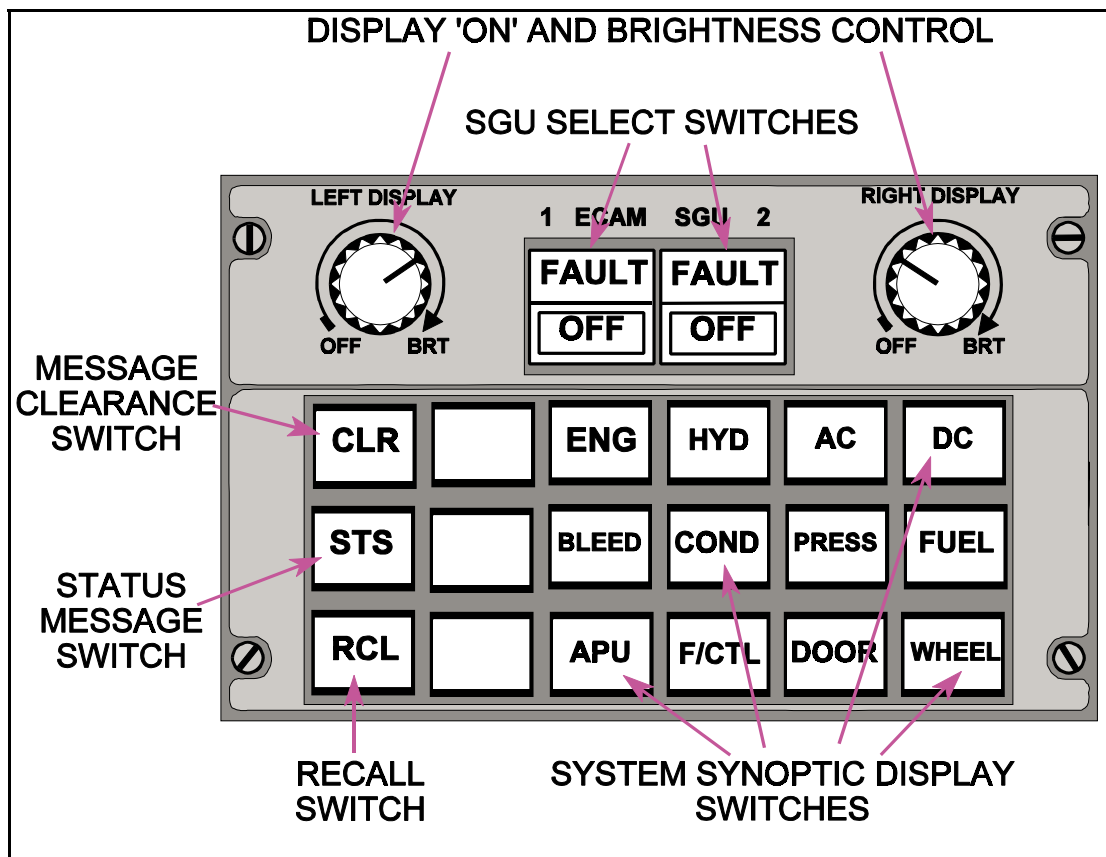

Figure 40.15 The ECAM Control Panel

CLR Switch. The light in the switch is illuminated white whenever a warning or status message is displayed on the left-hand display unit. The Switch is pressed to clear messages.

STS Switch. The Status Switch permits manual selection of an aircraft status message if no warning is displayed; illuminated white. Pressing the switch also causes the 'CLR' switch to illuminate. A status message is suppressed if a warning occurs or if the 'CLR' switch is pressed.

RCL Switch. The Recall Switch enables previously cleared warning messages to be recalled provided the failure conditions which initiated them still exist. Pressing the switch also causes the CLR switch light to illuminate. If a failure no longer exists the message 'NO WARNING PRESENT' is displayed on the left-hand display unit.

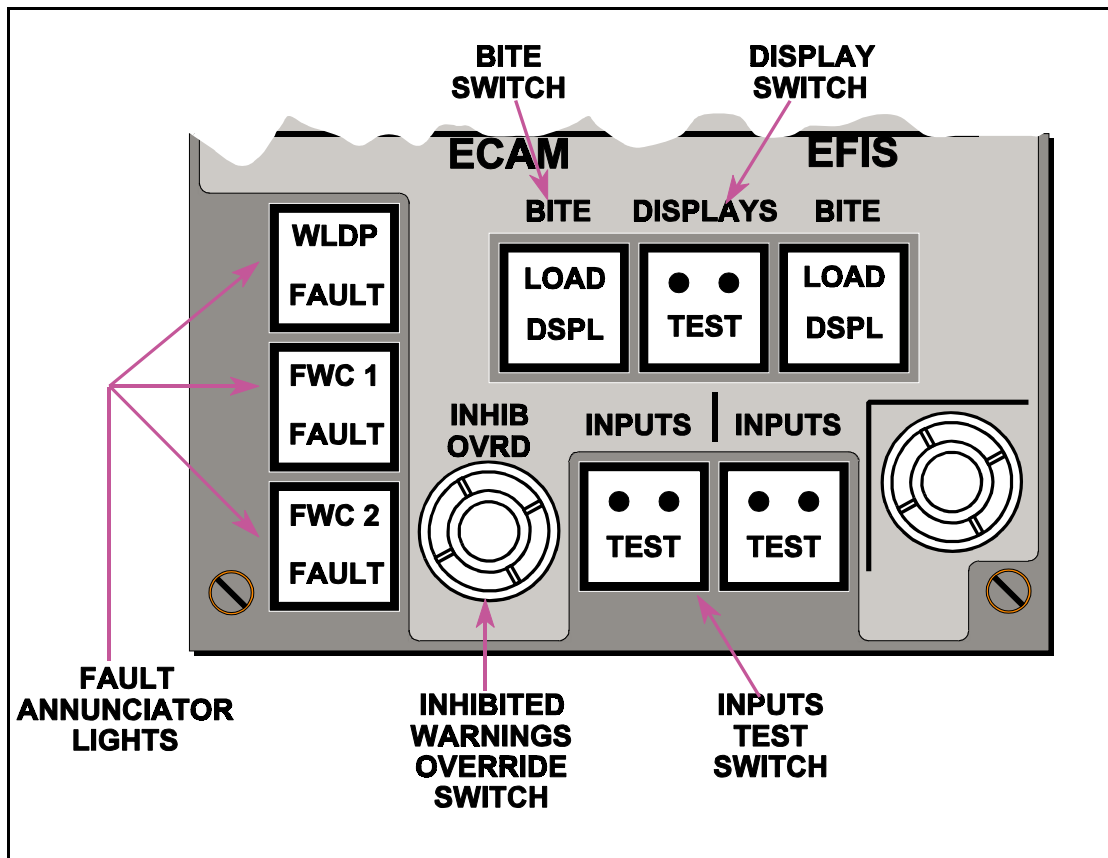

Figure 40.16 The ECAM Maintenance Panel

SYSTEM TESTING

Each flight warning computer of the system is equipped with a monitoring module which automatically checks data acquisition and processing modules, memories, and the internal power supplies as soon as the aircraft's main power supply is applied to the system. A power-on test routine is also carried out for correct operation of the symbol generator units. During this test the display units remain blank.

In the event of failure of the data acquisition and processing modules, or of the warning light display panel, a 'failure warning system' light on the panel is illuminated. Failure of a computer causes a corresponding annunciator light on the maintenance panel, captioned 'FWC FAULT', to illuminate.

A symbol generator unit failure causes a 'FAULT' caption on the appropriate push-button switch on the system control panel to illuminate.

Manual self-test checks for inputs and displays are carried out from a maintenance panel shown in Figure 40.16.

When the 'INPUTS' switch is pressed, a 'TEST' caption is illuminated white and most of the inputs to each computer are checked for continuity.

Any incorrect inputs appear in coded form on the left-hand display unit. The right-hand display unit presents a list of defective parameters at the system's date analog converter.

The diagrams of systems appear on the right-hand display unit with the caption 'TEST' beside the system title, as each corresponding push-button switch is pressed. Calibrated outputs from the data analog converter are also displayed.

Any defective parameters are identified by a flag display.

A '**DISPLAY**' push-button switch is provided on the maintenance panel. When pressed it initiates a check for correct operation of the Symbol Generator Units (SGU's), and the optical qualities of the display units by means of a test pattern display.

The '**LOAD**' caption is illuminated each time a failure is memorized in the relevant test circuits of the SGUs.

The annunciator lights on the maintenance panel illuminate white simultaneously with a failure warning system light on the central warning light display panel when a corresponding computer fails.

The '**INHIB OVRD**' switch enables inhibited warnings to be displayed.

QUESTIONS

1. With an Engine Indicating and Crew Alerting System:
 - a. the secondary display will show continuously the engine primary instruments.
 - b. the primary display unit will continuously show the engine primary instruments such as N1 N2 N3 and maybe oil pressure.
 - c. the primary engine display will continuously show the engine primary instruments such as N1 EGT and maybe EPR.
 - d. the primary engine instruments are N1 EGT and EPR and are on the primary and secondary display units.

2. The electronic engine display system with three automatic modes is:
 - a. the Electronic Centralised Aircraft Monitor, with the fourth mode manual.
 - b. the Electronic Centralised Aircraft Monitor, with the fourth mode flight phase related or manual.
 - c. the Engine Indicating and Crew Alerting System, with the fourth mode manual
 - d. the Engine Indicating and Crew Alerting System, with the fourth mode a manual cross over from the Electronic Centralised Aircraft Monitor System.

3. The display modes for the Engine Indicating and Crew Alerting System are:
 - a. operational, status and maintenance of which status and maintenance are automatic.
 - b. flight phase related, advisory and failure related.
 - c. operational, status and maintenance.
 - d. operational, flight phase related and status.

4. With an Engine Indicating and Crew Alerting System lower display unit failure:
 - a. a compact message will only appear on the upper display unit.
 - b. a compact message will only appear on the central display unit.
 - c. a compact message will appear both on the upper display unit and the captains Electronic Flight Instrument System.
 - d. a compact message will appear on the upper display unit when the status button is pressed on the control panel.

5. With an Electronic Centralised Aircraft Monitoring type of system:
 - a. the display units have two control panels and with any system failure the control will be from the port control box only.
 - b. the left display unit shows warning and corrective action in a check list format.
 - c. the two display units are only fitted side by side.
 - d. the left display unit shows the synoptic format and the right or lower unit shows the corrective format.

6. The Engine Indicating and Crew Alerting System alert messages are shown on the upper display unit in three forms:
 - a. Level 'C' are warnings that require immediate corrective action.
 - b. Level 'A' are cautions that require immediate crew awareness and possible action.
 - c. Level 'B' are advisories requiring crew awareness.
 - d. and these messages appear on the top left of the upper display unit.

7. The electronic engine display system will have:
 - a. one primary and one secondary display unit for an EICAS and a change over selector to change to the ECAM mode if necessary.
 - b. two display units for ECAM and three display units for EICAS.
 - c. either EICAS or ECAM but not both.
 - d. an interconnect to the EFIS symbol generators in an emergency.

8. In an Engine Indicating and Crew Alerting System if both displays fail then the following information is displayed on the standby engine indicator:
 - a. N1, EGT, N2.
 - b. N1, EGT, EPR.
 - c. N2, EGT, EPR.
 - d. N4, EGT, EPR.

9. The Electronic Centralised Aircraft Monitor (ECAM) type of system shows a:
 - a. checklist format on the left display panel and schematic form always automatically on the right display unit.
 - b. checklist format on the left display unit and the right, or lower display unit, a diagram or synoptic format.
 - c. synoptic format on the left display unit and a warning and corrective action display on the right or lower display unit.
 - d. continuous primary engine display on the primary display unit.

10. The electronic display system that has three automatic modes plus one manual is the:
 - a. Electronic Management and Control Section.
 - b. Electronic Indication and Fail Safe system.
 - c. Electronic Indication and Crew Alert system.
 - d. Electronic Centralised Aircraft Monitor.

11. A boxed message shown as an electronic engine display system fault is one that:
 - a. affects other sub-systems and is used in the Engine Indicating and Crew Alerting System.
 - b. does not affect any other system.
 - c. does not affect any other system and is used in the Engine Indicating and Aircraft Monitor system.
 - d. affects other sub-systems and is used in the Electronic Centralised Aircraft Monitor type of system.

12. An engine fire indication on an electronic engine display is shown:
 - a. on the primary display panel in red.
 - b. on the secondary display panel in amber.
 - c. on both the Electronic Flight Instrument System and Engine Indicating and Crew Alerting System secondary panels.
 - d. only on the Flight Management Computer primary panel.

13. An engine electronic system which in normal conditions of flight shows only the primary engine instruments is:
- a. An EICAS system with EPR, EGT and N2 shown on the primary instruments.
 - b. An ECAM system with the primary engine instruments displayed on the lower screen.
 - c. An EICAS system with the primary engine instruments displayed on the primary screen, the secondary screen being blank.
 - d. An ECAM system with the primary engine instruments displayed on the primary screen, the left screen being blank.

ANSWERS

- | | |
|----|---|
| 1 | C |
| 2 | A |
| 3 | C |
| 4 | A |
| 5 | B |
| 6 | D |
| 7 | C |
| 8 | A |
| 9 | B |
| 10 | D |
| 11 | D |
| 12 | A |
| 13 | C |

ATPL GROUND TRAINING SERIES

Aircraft General Knowledge 4



Revision Questions

CHAPTER FORTY ONE

REVISION QUESTIONS

Contents

FLIGHT INSTRUMENTS601
ANSWERS TO FLIGHT INSTRUMENTS QUESTIONS626
AUTOMATIC FLIGHT627
ANSWERS TO AUTOFLIGHT QUESTIONS638
WARNING & RECORDING639
ANSWERS TO WARNING & RECORDING QUESTIONS646
ENGINE INSTRUMENTS.647
ANSWERS TO ENGINE INSTRUMENTS QUESTIONS.656
SPECIMEN QUESTIONS657
EXPLANATIONS TO SPECIMEN QUESTIONS668
SPECIMEN EXAMINATION PAPER676
ANSWERS TO SPECIMEN EXAMINATION PAPER686

FLIGHT INSTRUMENTS

- 1 A 2 axis gyro, measuring vertical changes will have:
- a one degree of freedom, vertical axis
 - b two degrees of freedom, vertical axis
 - c one degree of freedom, horizontal axis
 - d two degrees of freedom, horizontal axis
- 2 The properties of a gyro are:
- 1. mass
 - 2. rigidity
 - 3. inertia
 - 4. precession
 - 5. rotational speed
- a. 1,2, & 3
 - b. 2 & 4
 - c. 2 & 3
 - d. 1 & 3
- 3 An aircraft fitted with a DRMC upon landing in a northerly direction will indicate:
- a no change
 - b oscillation about north
 - c a turn towards east
 - d a turn towards west
- 4 Which of the following will effect a direct reading compass?
- 1. ferrous metals
 - 2. non-ferrous metals
 - 3. electrical equipment
- a. 1 only
 - b. 1 & 3
 - c. 1 & 2
 - d. all 3
- 5 A vibrator may be fitted to an altimeter to overcome:
- a friction
 - b hysteresis
 - c lag
 - d pressure error
- 6 An aircraft is flying at constant indicated altitude, over a warm airmass. The altimeter reading will be:
- a correct
 - b greater than the real altitude
 - c less than the real altitude
 - d oscillating around the correct altitude

- 7 The machmeter consists of:
- a an airspeed indicator with mach scale
 - b an airspeed indicator with an altimeter capsule
 - c an altimeter corrected for density
 - d a VSI and altimeter combined
- 8 CAS is IAS corrected for:
- a position and instrument error
 - b instrument, pressure and density error
 - c relative density only
 - d compressibility
- 9 A DGI has;
- a one degree of freedom & a horizontal spin axis
 - b two degrees of freedom & a vertical spin axis
 - c two degrees of freedom & a horizontal spin axis
 - d one degree of freedom & a vertical spin axis
- 10 An aircraft is flying at an indicated altitude of 16,000ft. The outside air temperature is -30°C
What is the true altitude of the aircraft?
- a 16,200 ft
 - b 15,200 ft
 - c 18,600 ft
 - d 13,500 ft
- 11 The main cause of error in a DRMC is:
- a parallax in the rose
 - b turning
 - c magnetic deviation
 - d latitude
- 12 QNH is:
- a the airfield barometric pressure
 - b the setting that will give zero indication on the airfield
 - c the equivalent sea level pressure at the airfield
 - d the setting that will indicate airfield height
- 13 What is the Schuler period?
- a 21 minutes
 - b 84 minutes
 - c 1 oscillation in azimuth
 - d 63 minutes

- 14 The vertical reference of a data generation unit is:
- a horizontal axis with 1 degree of freedom
 - b vertical axis with 1 degree of freedom
 - c horizontal axis with 2 degree of freedom
 - d vertical axis with 2 degree of freedom
- 15 The torque motor of a gyro stabilised magnetic compass:
- a precesses the directional gyro
 - b takes its input from the flux valve
 - c moves the heading pointer
 - d moves the Selsyn stator
- 16 A factor giving an error on a direct indicating compass would be:
- a crosswinds – particularly on east/west headings
 - b parallax due to oscillations of the compass rose
 - c acceleration on east/west headings
 - d turning through east/west headings
- 17 A rate integrating gyro is used in:
- 1. inertial attitude unit
 - 2. autopilot system
 - 3. stabiliser servo mechanism system
 - 4. inertial navigation unit
 - 5. rate of turn indicator
- a 1, 2, 3, 4, & 5
 - a 1 & 4
 - b 2, 3, & 5
 - c 2, 3, & 4
- 18 The errors of a DGI are:
- 1. earth rate
 - 2. transport wander
 - 3. banking when pitched up
 - 4. annual movement of poles
 - 5. mechanical problems
- a 2, 3, & 5
 - b 3, 4, & 5
 - c 1, 2, 3, & 5
 - d all 5
- 19 An Air Data Computer (ADC) obtains altitude from:
- a. outside air temperature
 - b. barometric data from static source
 - c. time elapsed for signal to travel to and return from the earth
 - d. difference between absolute and dynamic pressure

- 20 If the needle and the ball of a Turn & Slip indicator both show right, what does it indicate:
- turn to left & too much bank
 - turn to right & too much bank
 - turn to left & too little bank
 - turn to right & too little bank
- 21 What formula gives the total temperature (T_T) from the static temperature (T_S):
- $T_T = T_S(1 + 0.2 M^2)$
 - $T_T = T_S(1 + 0.2 KrM^2)$
 - $T_T = T_S / (1 + 0.2 KrM^2)$
 - $T_T = T_S(1 - 0.2 M^2)$
- 22 The Inertial Strapdown Unit of an IRS is programmed with co-ordinates during alignment in order to:
- establish the trihedron with reference to the earth
 - establish true or magnetic heading
 - check the function of the laser gyros
 - compensate for aircraft movement
- 23 When descending through an isothermal layer at constant CAS, what does the TAS do?
- increase at a linear rate
 - increase at an exponential rate
 - remain the same
 - decrease
- 24 What is V_{MO} calculated from:
- CAS
 - TAS
 - COAS
 - EAS
- 25 Descending from FL390 at maximum groundspeed, what will the pilot be limited by:
- V_{MO} initially then M_{MO} at a specified altitude
 - M_{MO} initially then V_{MO} at a specified altitude
 - V_{NE} initially then M_{MO} at a specified altitude
 - V_{NO} initially then V_{NE} at a specified altitude
- 26 At constant weight, regardless of altitude, an aircraft always lifts off at a constant:
- EAS
 - TAS
 - ground speed
 - CAS

- 27 V_{FE} is the maximum speed that:
- the flaps can be operated
 - the flaps may be extended in the take-off configuration
 - the flaps may be extended in the landing configuration
 - the flaps may be extended in a specified configuration
- 28 The white arc on the ASI indicates:
- V_{SI} at the lower end and V_{LE} at the upper end
 - V_{SO} at the lower end and V_{LE} at the upper end
 - V_{SO} at the lower end and V_{FE} at the upper end
 - V_{SI} at the lower end and V_{FE} at the upper end
- 29 An ASI circuit consists of pressure sensors. The Pitot Probe measures:
- total pressure & static pressure
 - dynamic pressure
 - static pressure
 - total pressure
- 30 Mach number is defined as the ratio of:
- IAS to LSS
 - TAS to LSS
 - CAS to LSS
 - EAS to LSS
- 31 If a pitot source is blocked in an ASI, and the drain hole is blocked, but the static source is open, what will happen?
- ASI reading goes to zero
 - ASI under reads
 - ASI over reads
 - ASI behaves like an altimeter
32. In a turn at constant angle of bank ... the rate of turn is:
- independent of weight and proportional a to TAS
 - dependant on weight and inversely proportional to TAS
 - independent of weight and inversely proportional a to TAS
 - dependant on weight and proportional to TAS
33. The Turn Indicator is a useful gyroscopic instrument. When used in association with an attitude indicator will show:
- angular velocity about the yaw axis
 - direction of turn
 - angular velocity about true vertical axis
 - speed of turn
- 1, & 3
 - 2, & 3
 - 3, & 4
 - 1, & 2

- 34 If an aircraft, fitted with a DRMC, takes off on a westerly heading, in the northern hemisphere, the DRMC will indicate:
- a a turn to the north
 - b oscillates about west
 - c no turn
 - d a turn to south
- 35 When turning through 90° at constant attitude and bank, a classic Artificial Horizon indicates:
- a nose up and correct angle of bank
 - b attitude and bank angle are correct
 - c nose up and bank angle too low
 - d nose up and bank angle too high
- 36 The factors which will affect a Turn Indicator are:
- 1. angle of bank
 - 2. aircraft speed
 - 3. aircraft weight
- a. all 3
 - b. 1 & 2
 - c. 1 & 3
 - d. 2 & 3
- 37 To obtain heading information from a Gyro Stabilised platform, the gyros should have:
- a 1 degree of freedom and a horizontal axis
 - b 1 degree of freedom and a vertical axis
 - c 2 degrees of freedom and a horizontal axis
 - d 2 degrees of freedom and a vertical axis
- 38 What are the inputs to the ADC?
- 1. OAT
 - 2. dynamic pressure
 - 3. TAT
 - 4. static pressure
 - 5. electric power
 - 6. pitot pressure
 - 7. AOA
- a. 1, 2, 5 & 6
 - b. all 7
 - c. 3, 4 & 6
 - d. 3, 4, 5, 6, & 7

- 39 The properties of a Turn Indicator are:
1. One degree of freedom
 2. two degrees of freedom
 3. two springs connected to the aircraft frame
 4. spin axis in the longitudinal plane
 5. spin axis parallel to the yaw axis
 6. spin axis horizontal
- a 1, & 6
 b 2, & 5
 c 1, & 4
 d 2, & 6
- 40 A gravity erector system corrects errors on a:
- a. DGI
 - b. artificial horizon
 - c. turn indicator
 - d. RIMC
- 41 In a Gyro magnetic Compass the flux gate transmits information to the:
- a heading indicator
 - b amplifier
 - c error detector
 - d erecting system
- 42 V_{NO} is the max. speed which:
- a the pilot can fully deflect the controls.
 - b should only be exceeded in still air and with caution.
 - c should never be exceeded.
 - d must not be exceeded for flap/gear extension
- 43 If while level at FL 270, at a constant CAS, temperature falls, what happens to the Mach No.
- a decreases.
 - b increases.
 - c remains constant.
 - d increases depending on whether temp >ISA or < ISA.
- 44 If the static vent becomes blocked on an unpressurised a/c, what could you do?:
- a open the window.
 - b break the VSI glass.
 - c compute altitude mathematically.
 - d Select standby pitot source
- 45 What does the "barbers pole" on an ASI indicate?:
- a V_{MO} & altitude.
 - b V_{MO} & temperature.
 - c V_{NO}
 - d V_{NE}

- 46 On board a/c, true altitude shown from:
- a standard atmosphere.
 - b pressure altitude.
 - c density altitude.
 - d temperature altitude.
- 47 On a turn and slip indicator, needle to the left and ball to the right indicates:
- a turn to the right, not enough bank.
 - b turn to the left, too much bank.
 - c turn to the left, not enough bank.
 - d turn to the right, too much bank.
- 48 What is density altitude:
- a altitude in the standard atmosphere at which the prevailing density is equal to the density in the standard atmosphere
 - b pressure altitude corrected for prevailing temp.
 - c temperature altitude.
 - d pressure corrected
- 49 A radio altimeter is:
- a ground based and measures true altitude.
 - b ground based and measures true height.
 - c a/c based and measures true altitude.
 - d a/c based and measures true height.
- 50 An a/c is travelling at 120 kts, what angle of bank would be required for a rate 1(one) turn:
- a. 30°
 - b. 12°
 - c. 18°
 - d. 35°
- 51 An a/c is travelling at 100 kts forward speed on a 3° glideslope. What is its rate of descent?:
- a 500 ft/min.
 - b 300 ft/min.
 - c 250 ft/min.
 - d 600 ft/min.
- 52 If the pitot tube is leaking (and the pitot drain is blocked) in a non-pressurised a/c, the ASI will:
- a under-read.
 - b over-read.
 - c over-read in the climb, under-read in the descent.
 - d under-read in the climb, over-read in the descent.

- 53 An RMI rose is mechanically stuck on 090 degrees. The ADF pointer indicates 225 degrees. What is the relative bearing to the beacon?
- a 225 degrees.
 - b 135 degrees.
 - c Cannot be determined.
 - d 000 degrees.
- 54 Using a classic Artificial Horizon, the a/c performs a right turn through 270 degrees at a constant angle of bank and rate of turn. The indication is:
- a Nose up, too much bank.
 - b Nose up, not enough bank.
 - c Nose up, wings level.
 - d Bank and pitch correct.
- 55 In a DGI what error is caused by the gyro movement relative to the earth?
- a. Earth Rate
 - b. Transport Wander
 - c. real wander
 - d. latitude error
- 56 In a right turn while taxiing, the correct indications are:
- a Needle left, ball right.
 - b Needle left, ball left.
 - c Needle right, ball right.
 - d Needle right, ball left.
- 57 An aircraft is taking off on a runway heading 045° , in still air, with a compass having 0° deviation. The runway is on an agonic line. What are the northerly turning errors (northern hemisphere)?
- a. compass moves to less than 045°
 - b. compass moves to more than 045°
 - c. compass stays on 045° if wings are kept level
 - d. compass remains on 045°
- 58 True heading can be converted into magnetic heading using a compass and:
- a A map with isogonal lines.
 - b A map with isoclinal lines.
 - c A deviation card.
 - d A deviation curve
- 59 At sea level ISA, TAS:
- a Equals CAS
 - b Is greater than CAS
 - c Is less than CAS

- 60 What will the altimeter read if the layers beneath the aircraft are all colder than standard?
- a read lower than the real altitude
 - b read higher than the real altitude
 - c read the correct altitude
 - d readings will fluctuate
- 61 The flux valve in a RIMC
- a is supplied with AC current (usually 487.5 Hz).
 - b is fed with DC.
 - c is made of perm-alloy magnetic steel.
 - d has its own self exciter unit.
- 62 The indications of a machmeter are independent of:
- a Temperature (OAT)
 - b Static Pressure
 - c Differential static and dynamic Pressure
 - d Dynamic Pressure
- 63 An artificial horizon has:
- a 1 degree of freedom and an horizontal axis.
 - b 2 degree of freedom and an horizontal axis.
 - c 1 degree of freedom and a vertical axis.
 - d 2 degree of freedom and a vertical axis.
- 64 The rigidity of a gyro is improved by:
- a Increasing RPM and concentrating the mass on the periphery of the rotor.
 - b Increasing RPM and concentrating the mass at the hub of the rotor.
 - c Decreasing RPM and concentrating the mass on the periphery of the rotor.
 - d Decreasing RPM and concentrating the mass at the hub of the rotor.
- 65 What is the speed of sound at sea level ISA
- a 644kts.
 - b 661kts.
 - c 1059 kts
 - d 583kts.
- 66 What is the speed of sound at 25,000 ft and -28 degrees C.
- a 624kts.
 - b 618kts.
 - c 601kts
 - d 610kts.
- 67 What is the speed of sound at 30,000 ft and -40 degrees C.
- a 562kts.
 - b 595kts.
 - c 590kts.
 - d 661kts.

- 68 If a constant CAS is maintained in a climb, what happens to the mach number
- remains constant
 - increases
 - decreases
- 69 A compass swing is used to:
- align compass north with magnetic north.
 - align compass north with true north.
 - align magnetic north with true north.
 - get true north and lubber line aligned.
- 70 The TAT probe measures TAT by:
- $TAT = SAT + \text{kinetic heating.}$
 - $TAT = SAT - \text{heating due to compressibility.}$
 - $TAT = SAT - \text{kinetic heating.}$
 - $TAT = SAT + \text{heating due to compressibility.}$
- 71 If a pitot tube and drains are blocked at altitude by icing, during a descent the ASI will:
- read constant airspeed.
 - under read.
 - over read.
 - show zero.
- 72 An IRS is aligned when turned on so as to:
- calculate the computed trihedron.
 - establish true and magnetic north.
 - establish position relative to true north and magnetic north.
 - establish magnetic north.
- 73 The advantages of an ADC over a traditional pitot - static system (list)
- Position and compressibility correction.
 - reduced lag
 - ability to supply many instruments
 - ability to act as an altimeter following failure.
 - (apparently all the answer bar one had 4 as a correct answer)
- 1, 2 & 3
 - 1, 2 & 4
 - 2, 3 & 4
 - 1, 3 & 4
74. The frequency band used for a Radio Altimeter is:
- SHF
 - VHF
 - UHF
 - LF

- 75 What is the purpose of the latitude nut in a DGI?
- to correct for latitude error
 - to correct for transport wander
 - to correct for earth rate
 - to correct for coriolis error
- 76 Total Air Temp is always _____ than Static Air Temp and the difference varies with _____.
- warmer, altitude.
 - colder, altitude.
 - warmer, CAS.
 - colder, CAS.
- 77 In a slightly banked turn, the turn needle will indicate:
- roll rate.
 - rate of yaw.
 - angular velocity about the vertical axis.
 - rate of pitch.
- 78 The Primary Flying Display (PFD) displays information dedicated to:
- engine data and alarms
 - flight path
 - weather radar
 - aircraft systems
- 79 What are the inputs to the FMS?
- Radio Aids
 - Engine Parameters
 - Air Data
 - Route Data
 - Terminal Data
 - Operating Data
- 1, 3, 4 & 6
 - 2, 3, 4, & 5
 - All of the above
 - 1, 2, 3 & 6
80. What are the upper and lower limits of the yellow arc on an ASI?
- lower limit V_{LO} and upper limit V_{NE}
 - lower limit V_{LE} and upper limit V_{NE}
 - lower limit V_{NO} and upper limit V_{NE}
 - lower limit V_{LO} and upper limit V_{LE}

81. What does the blue line on an ASI of a twin propeller engined aircraft indicate?
- V_{YSE}
 - V_{NO}
 - V_{FE}
 - V_{MCA}
82. The gravity erecting device on a vertical gyro is used on which instrument;
- directional gyro unit
 - turn indicator
 - artificial horizon
 - gyromagnetic device
83. In a VSI lag error is improved by:
- bi-metallic strip
 - two
 - use of an accelerometer system
 - return spring
84. An aircraft fitted with a DRMC is landing in a southerly direction, in the Southern Hemisphere. What indications will be seen on the DRMC?
- 180° turn to east
 - no apparent turn
 - turn to west
85. What is the maximum drift of a gyro, due to earth rate:
- 90° per hour
 - 180° per hour
 - 15° per hour
 - 5° per hour
86. An aircraft is flying a true track of 360° from 5° south to 5° north. What is the change in apparent wander rate:
- 0° per hour
 - $+5^{\circ}$ per hour
 - -5° per hour
 - depends upon groundspeed
87. When turning through 180° at constant attitude and bank, a classic Artificial Horizon indicates:
- nose up and correct angle of bank
 - attitude and bank angle are correct
 - nose up and bank angle too low
 - nose up and bank angle too high

88. What is the Schuler period?
- 48 minutes
 - 84 seconds
 - 48 seconds
 - 84 minutes
89. Mach number is defined as:
- The ratio of pitot pressure to dynamic pressure
 - The ratio of static pressure to dynamic pressure
 - The ratio of dynamic pressure to static pressure
 - The ratio of static pressure to pitot pressure
90. You are flying at a constant FL 290 and constant mach number. The total temperature increases by 5° . The CAS will:
- remain approximately constant
 - increase by 10 kts
 - decrease by 10 kts
 - will increase or decrease depending on whether you are above or below ISA.
91. An aircraft turns from south-west to south-east when situated at 45°N , what heading should you roll out on if using a DRMC?
- 130°
 - 115°
 - 140°
 - 155°
92. What is SAT?
- relative temperature measured in K
 - differential temperature measured in K
 - relative temperature measured in $^{\circ}\text{C}$
 - ambient temperature measured in $^{\circ}\text{C}$
93. If an aircraft climbs, at constant mach No, in ISA conditions what happens to the TAS and the CAS?
- TAS increases and CAS increases
 - TAS remains constant and CAS decreases
 - TAS decreases and CAS increases
 - TAS decreases and CAS decreases
94. Where is the earth rate wander, and the transport wander of a gyro equal to zero?
- North Pole
 - Equator
 - 45°N
 - 45°S

95. What happens when the static pressure supply, to an altimeter, becomes blocked during a descent?
- reduces to zero
 - over reads
 - under reads
 - indicates altitude at which blockage occurred
96. What happens when the static vent supplying an ASI is blocked, and the ram air inlet remains clear?
- ASI acts opposite to an altimeter
 - ASI always over reads / reads a higher value
 - ASI always under reads / reads a lower value
 - ASI acts like an altimeter
97. In a left turn while taxiing, the correct indications are:
- Needle left, ball right.
 - Needle left, ball left.
 - Needle right, ball right.
 - Needle right, ball left.
98. V_{LO} is defined as:
- the maximum speed at which to fly with the landing gear retracted
 - the maximum speed at which the landing gear may be retracted or extended
 - the maximum speed at which to fly with the landing gear extended
 - the minimum speed at which to fly with the landing gear extended
99. V_{NE} is defined as:
- the speed which must not be exceeded in still air, or without caution
 - the speed above which the landing gear may not be extended
 - the speed which must never be exceeded
 - the maximum speed for normal flap extension to be selected
100. In a left turn, the ball of the turn co-ordinator is out to the right, what corrective action is required?
- more right rudder
 - less right bank
 - more left bank
 - more left rudder
101. In a gyro magnetic compass, where does the torque motor get its information from?
- the flux gate
 - error detector
 - the rotor gimbal
 - amplifier

102. If an aircraft is descending at constant mach number, and the total air temperature remains constant, what happens to the CAS?
- remains constant
 - decreases
 - increases
 - increases if the temperature is below standard, and decreases if the temperature is above standard
103. What are the advantages of a laser gyro compared to a conventional gyro?
- has a longer cycle life
 - takes longer to set up/ spin up
 - uses more power
 - takes longer to align
104. A machmeter measures the ratio of;
- pitot pressure to static pressure
 - (pitot pressure minus static pressure) to static pressure
 - pitot pressure times static pressure
 - pitot pressure to (static pressure times pitot pressure)
105. Which instrument has a 2° rotation in the horizontal axis?
- artificial horizon
 - flux detector
 - directional gyro indicator
 - turn indicator
106. The maximum drift error sensed by an uncompensated DGI will be:
- 15° per hour
 - 30° per hour
 - 45° per hour
 - 60° per hour
107. The green arc on the ASI is used to identify which speed range:
- V to V
 - V^{SO} to V^{NO}
 - V^{S1} to V^{FE}
 - V_{S1}^{S1} to V_{LO}^{NO}
108. Pressure altitude may be defined as:
- lowest forecast regional pressure
 - pressure measured in the standard atmosphere
 - altitude indicated with QFE set on the altimeter
 - altitude indicated with QNH set on the altimeter

109. What is the effect on an altimeter reading if variations in static pressure occur near to the pressure source?
- a change in hysteresis error
 - a change in the instrument error
 - a change in the position error
 - a change in the compressibility error
110. What is the value of the angle of magnetic dip at the South Pole?
- 0°
 - 45°
 - 90°
 - 60°
111. A standby artificial horizon must have the following properties:
- a remote gyro
 - its own power supply
 - only to be used in emergency
 - its own gyro
 - one for each certified pilot
- all the above
 - 1,3, & 5
 - 2, 3, & 4
 - 2 & 4
112. During a descent at constant CAS and total temperature, the mach no:
- increases
 - remains constant
 - increases if SAT is greater than standard temperature and decreases if it is lower
 - decreases
113. The single most significant item which makes a servo altimeter more accurate is:
- electromagnetic pick-off
 - logarithmic scale
 - temperature compensated spring
 - multiple pointers
114. Which of the following gyro instruments has one degree of freedom?
- artificial horizon
 - turn indicator
 - directional gyro
 - slaved gyro compass

115. If a large aircraft is side slipped to starboard, and the port static vent is blocked, what will the altimeter read?
- under read
 - read correctly
 - Over read
 - fluctuate
116. Mach number is determined from: (P_T = total pressure, P_S = static pressure)
- $(P_T + P_S) \times P_T$
 - $(P_T - P_S) \times P_S$
 - $(P_T \times P_S) \times P_T$
 - $(P_T - P_S) / P_S$
117. The right static vent is blocked, when the aircraft yaws to the right. Does the altimeter:
- Over read
 - under read
 - unaffected
 -
118. If the radio altimeter fails:
- height information disappears
 - aural warning given
 - radio alt flag, red lamp, and aural warning given
 - radio alt flag and red lamp activates.
119. During a descent at a constant mach number, there is an increase of total temperature by 5°. What effect does this have on CAS?
- remains almost constant
 - increases if SAT is more than standard and decreases if SAT is less than standard
 - increases by 10 kts
 - decreases by 10 kts
120. V_{NO} is defined as:
- maximum structural cruising speed
 - never exceed speed
 - manoeuvring speed
 - maximum operating speed
121. If the left static vent is blocked, and the right static vent is clear. What will the altimeter read if the aircraft maintains constant level?
- read correctly whatever the situation
 - under read
 - if side slipping to the left, altimeter will over read.
 - if side slipping to the right, altimeter will over read.

122. An aircraft is flying at constant indicated altitude, over a cold airmass. The altimeter reading will be:
- greater than the real altitude
 - standard altitude
 - same as the real altitude
 - less than the real altitude
123. The machmeter compares: (P_T = total pressure, P_S = static pressure)
- $(P_T - P_S)$ to P_T
 - $(P_T + P_S)$ to P_S
 - $(P_T - P_S)$ to P_S
 - P_T to P_S
124. From where does the air data computer (ADC) obtain aircraft altitude?
- OAT probe
 - dynamic – absolute ambient pressure
 - absolute barometric sensor on aircraft fuselage
 - IRS
125. An aircraft is accelerating to take-off on a runway with a QDM of 045° . Which way does the DRMC move, if the aircraft is in the Northern Hemisphere?
- less than 45°
 - more than 45°
 - correct if wings are level
 - correct
126. When turning right onto north, through 90° , what heading on your DIC should you roll out on, if the aircraft is in the Northern Hemisphere?
- 020°
 - 360°
 - 340°
 - 320°
127. What does a radio altimeter, for an aircraft in the landing configuration, measure:
- height of aircraft wheels above the ground
 - height of the aircraft above the ground
 - altitude of the aircraft
 - altitude of the aircraft wheels
128. Why is a servo altimeter better than a sensitive altimeter/
- it has a pick-off coil
 - it is more accurate at low level
 - it has ambient pressure in the capsule
 - it is fitted with a knocking device

129. In an altimeter what is fed to: the capsule (i) and to the case (ii)?
- a. (i) vacuum (ii) static input
 - b. (i) static input (ii) vacuum
 - c. (i) pitot input (ii) static input
 - d. (i) total input (ii) ambient input
130. What principle does the radio altimeter work on?
- a. pulse modulation
 - b. amplitude modulation
 - c. pulse modulation and carrier wave
 - d. frequency modulation and carrier wave
131. What is indicated on the ASI when the static vent blocks during a descent?
- a. under reads
 - b. reads correctly
 - c. over reads
 - d. reads zero
132. A rate integrating gyro is used in:
- a. inertial attitude unit
 - b. autopilot system
 - c. inertial navigation system
 - d. a rate of turn indicator
133. The error in a Directional Gyro due to the earth's rotation, at a mean latitude of 45° N, will cause the spin axis to move by:
- a. 10.6° Clockwise
 - b. 10.6° Anti-clockwise
 - c. 7.6° Clockwise
 - d. 7.6° Anti-clockwise
134. What are the components of a Ring Laser Gyro?
- a. mirrors and 2 cavities
 - b. 2 anodes and 2 cathodes
 - c. 2 beams of laser light
 - d. horizontal gyro axis and 1 degree of freedom
135. Where on the earth's surface is the earth rate drift of a DGI equal to 15.04° per hour?
- a. 15°
 - b. 30°
 - c. 0°
 - d. 90°

136. If you maintain the same CAS and Altitude (FL270), and the temperature increases, what happens to the Mach No?
- increases at an exponential rate
 - decreases at an exponential rate
 - remains the same
 - increases
137. If CAS is kept constant, what happens to the Mach No?
- as the altitude increases the mach No will increase
 - as the altitude increases the mach No will decrease
 - as the temperature increases the mach No will increase
 - as the temperature decreases the mach No will decrease
138. The pendulous type correction detector fitted to the DGI provides:
- torque on the sensitive axis
 - two torque motors on the horizontal axis
 - pendulous internal nozzle on the outer gimbal
 - one torque motor
139. An aircraft is fitted with two altimeters. One is corrected for position error, the other is not corrected for position error.
- ATC will receive erroneous information of flight level
 - at high speed the non-compensated altimeter will show a lower altitude
 - provided that the ADC is working normally, there will be no error to either altimeter
 - at high speed the non-compensated altimeter will show a higher altitude
140. Density altitude is defined as:
- the altitude of the airfield elevation corrected for Lapse Rate
 - the altitude reading on the altimeter which has QNH set on it
 - the altitude corresponding to the standard atmosphere compensated for ambient density
 - the altitude showing on the altimeter with the lowest regional QNH set
141. The pitot tube of an ASI gives a direct reading of:
- static pressure
 - total & static pressure
 - total pressure
 - dynamic pressure
142. When descending from FL230 to FL50 at maximum speed, the limitations which apply are:
- V_{MO}
 - V_{MO} then M_{MO}
 - M_{MO} then V_{MO}
 - M_{MO}

143. The pressure measured at the forward face of the Pitot probe is:
- dynamic pressure
 - static pressure
 - total pressure
 - total pressure + static pressure
144. What has inputs from the flux valve;
- error detector
 - heading indicator
 - amplifier
 - precession motor
145. Machmeter readings are subject to which of the following errors;
- density error
 - setting error
 - temperature error
 - position/pressure error
146. Sound propagates at a speed which depends only on;
- density
 - temperature
 - temperature & pressure
 - pressure
147. What aircraft system uses a frequency of 4,400 MHz?
- SSR
 - radio altimeter
 - weather radar
 - ATC radar
148. A low altitude Radio Altimeter, used in precision approaches, has the following characteristics:
- 1540MHz to 1660 MHz range
 - pulse transmissions
 - frequency modulation
 - height range between 0 and 5,000ft
 - an accuracy of +/- 2ft between 0 and 500ft
- 1, 4 and 5
 - 3 and 4
 - 3 and 5
 - 2, 3 and 5

149. A modern low altitude Radio Altimeter uses the principle of:
- pulse modulated waves, with the difference between the transmitted and received waves displayed on a circular screen.
 - Frequency modulated waves, where the difference between the transmitted wave and the received wave is measured.
 - Wave modulation, with frequency shift due to Doppler effect of the ground reflected wave being measured
 - Triangular wave, with the frequency shift of the ground reflected wave being measured
150. The frequencies used in a low altitude Radio Altimeter are:
- 5 GHz to 6 GHz
 - 5400 MHz and 9400 MHz
 - 4200 MHz to 4400 MHz
 - 2700 MHz to 2900 MHz
151. The difference between Magnetic North and True North can be derived by:
- deviation curve
 - deviation card
 - map with isoclinic lines
 - map with isogonal lines
152. A direction gyro gets its directional information from:
- air data computer
 - direct reading magnetic compass
 - flight director
 - flux valve
153. What is the principle of operation of a VSI:
- differential pressure across a capsule
 - total pressure in a capsule
 - static pressure in a capsule
 - dynamic pressure in a capsule
154. In a Remote Indicating Compass, what component feeds the Amplifier?
- gyro precession signal
 - flux valve
 - annunciator
 - error detector
155. An aircraft turns right, through 90° , onto North, at 48N, using a direct indicating compass. The aircraft is turning at rate 2. What heading should the aircraft roll out on?
- 010°
 - 030°
 - 330°
 - 350°

156. What is the normal operating range of a low altitude Radio Altimeter?
- 0 to 2,500ft
 - 50ft to 2500ft
 - 0 to 10,000ft
 - 0 to 7,500ft
157. What is a radio altimeter used for?
- to determine aircraft height above mean sea level
 - to determine aircraft height above ground level
 - to determine pressure altitude
 - to determine aircraft altitude
158. Why must Latitude and Longitude be inserted into an IRS?
- to determine the aircraft position relative to the earth
 - to check the IRS position with the Flight Management System
 - to enable the levelling procedure to commence
 - to determine the accuracy of the alignment
159. An aircraft is flying a true track of 360° from 5° south to 5° north. What is the average apparent wander rate:
- 0° per hour
 - $+5^{\circ}$ per hour
 - -5° per hour
 - depends upon groundspeed
160. You commence a rate 2 turn from south-east to south-west, in the Northern Hemisphere. On what heading do you stop the turn?
- 240°
 - 255°
 - 235°
 - 205°
161. A directional gyro is valid only for a short period of time. The causes of this inaccuracy are;
- earth rotation
 - longitudinal accelerations
 - a/c motion over the earth
 - mechanical defects
 - gyro mass
- 1, 3 & 5
 - 1, 3 & 4
 - 1, 2 & 3
 - all of the above
162. A V_{MO} / M_{MO} alarm system, on an airline aircraft, is fitted with an aneroid capsule which is:
- subjected to static pressure and an anemometer subjected to dynamic pressure
 - subjected to dynamic pressure and an anemometer subjected to static pressure
 - subjected to static pressure and an anemometer subjected to static pressure
 - subjected to dynamic pressure and an anemometer subjected to dynamic pressure

163. An aircraft, in the southern hemisphere, is decelerating to land on a westerly heading. The direct reading magnetic compass will indicate:
- an apparent turn to north
 - an apparent turn to south
 - correctly
 - an oscillation about west
164. What is the input to a VSI?
- static pressure
 - differential pressure
 - total pressure
 - dynamic pressure
165. The component(s) used to align an inertial strap-down unit in the horizontal plane is/are:
- Accelerometers and gyroscopes
 - Accelerometers
 - Flow inductors
 - Gyroscopes
166. A ring laser gyro consists of;
- A gyro with 2 degrees of freedom
 - Two moving cavities using mirrors
 - A laser split into two beams
 - Two electrodes (anodes and cathodes)
167. The Directional Gyro Indicator (DGI) can:
- not align itself with magnetic north
 - can automatically align itself with magnetic north
 - have 1° of freedom
 - have 2° of freedom
168. The Pitot tube comprises a mast to position it below the skin of the aircraft for:
- avoid disturbance from aerodynamic flow about the aircraft
 - position it outside the boundary layer
 - anti-ice protection
 - easy access for maintenance
169. Using a classic Artificial Horizon, the a/c performs a right turn through 360 degrees at a constant angle of bank and rate of turn. The indication is:
- Nose up, too much bank.
 - Nose up, not enough bank.
 - Nose up, wings level.
 - Bank and pitch correct.

ANSWERS TO FLIGHT INSTRUMENTS QUESTIONS

1 B	31 D	61 A	91 B	121 C	151 D
2 B	32 C	62 A	92 D	122 A	152 B
3 A	33 D	63 D	93 D	123 C	153 A
4 B	34 A	64 A	94 B	124 C	154 D
5 A	35 C	65 B	95 D	125 A	155 C
6 C	36 B	66 D	96 A	126 C	156 A
7 B	37 A	67 B	97 A	127 A	157 B
8 A	38 D	68 B	98 B	128 A	158 A
9 C	39 A	69 A	99 C	129 A	159 A
10 B	40 B	70 D	100 C	130 D	160 B
11 B	41 C	71 B	101 D	131 C	161 B
12 C	42 B	72 A	102 C	132 C	162 A
13 B	43 C	73 A	103 A	133 A	163 A
14 D	44 B	74 A	104 B	134 C	164 A
15 A	45 A	75 C	105 A	135 D	165 A
16 C	46 B	76 C	106 A	136 C	166 C
17 B	47 C	77 C	107 C	137 A	167 D
18 C	48 A	78 B	108 B	138 A	168 A
19 B	49 D	79 C	109 C	139 D	169 D
20 B	50 C	80 C	110 C	140 C	
21 B	51 A	81 A	111 D	141 C	
22 A	52 A	82 C	112 D	142 C	
23 D	53 B	83 C	113 A	143 C	
24 D	54 A	84 B	114 B	144 A	
25 B	55 B	85 C	115 A	145 D	
26 D	56 D	86 C	116 D	146 B	
27 A	57 A	87 A	117 B	147 B	
28 C	58 A	88 D	118 A	148 B	
29 D	59 A	89 C	119 C	149 B	
30 B	60 B	90 A	120 A	150 C	

AUTOMATIC FLIGHT

1. The flight director command bars on the display shown are commanding

- a fly up and left
- b fly down and right
- c fly down and left
- d fly up and right

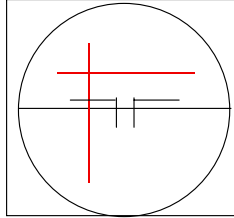

2. Where are the flight director modes displayed?

- a PFD
- b ND
- c EICAS
- d FD control panel

3. The autopilot is in heading select mode, and the aircraft is flying on a heading of 270°. If you change heading to 360°, the flight director command bars will;

- a. roll command bar goes full deflection right and then doesn't move until the aircraft heading is within 30° of the selected heading
- b. roll command bar moves to right and centres when AFDS angle of bank to intercept has been achieved
- c. the heading command bar will disappear and the heading hold will disengage
- d. roll command bar moves to the right and then progressively returns to the centre as the deviation from the selected heading reduces

4. What are the basic functions of an autopilot?

- 1. Maintain pitch attitude
- 2. Maintain wings level
- 3. Altitude hold
- 4. Heading hold
- 5. Speed hold

- a. all 5
- b. 1 & 2
- c. 1, 2 & 3
- d. 1, 2, 3, & 4

5. At 50 feet agl during an autoland, what happens to the glideslope signal?

- a continues to be actioned
- b is disconnected
- c is factored for range
- d is used to flare the aircraft

6. What is the wavelength of an ILS signal

- a.. Centimetric
- b. Hectometric
- c. Metric
- d. Decimetric

- 7 A Yaw damper indicator will indicate to the pilot:
- a yaw damper movement of rudder position
 - b rudder position
 - c rudder position due to pedal displacement
 - d yaw damper movement on ground only
- 8 The Autothrottle is set to climb at a constant mach number. If the temperature does not change, what happens to the CAS?
- a Increases
 - b Decreases
 - c Increases, but only if the outside air temperature decreases
 - d Stays the same
- 9 Autothrottle engaged mode can be checked by the pilot, using:
- a primary flight display
 - b thrust control computer
 - c position of throttles
 - d navigation display
- 10 The interception of the localiser beam by the autopilot is:
- a on a constant magnetic course
 - b a mode using an interception verses range computation
 - c a mode using an interception verses radio deviation law
 - d on a constant heading
- 11 Engagement of the autopilot is not possible when:
- 1. electrical supply is faulty
 - 2. the turn control knob is not set to centre off
 - 3. there is a synchronisation fault
 - 4. there is a fault in the attitude reference unit
- a 1, 2, 3, & 4
 - b 1, & 4 only
 - c 1, 3, & 4
 - d 2 & 4 only
12. On which instrument are the flight director bars normally present?
- a. Primary EICAS
 - b. ADI
 - c. ND
 - d. EHSI
13. What happens at 50ft whilst carrying out an autolanding?
- a. glideslope and localiser disconnect and aircraft continues to land
 - b. radio altimeter controls the rate of descent
 - c. radio altimeter controls the angle of attack
 - d. glideslope disconnects and aircraft continues descent

14. If you have selected a heading of 180° and are flying aircraft on heading of 160° to intercept the correct course, the ADI vertical bar be central when?
 - a. only if aircraft is subject to 20° port drift
 - b. only if aircraft is subject to 20° starboard drift
 - c. cannot be centralised
 - d. will only be central when flying correct attitude to intercept desired heading

15. If the autopilot is selected to VOR mode, what happens if the aircraft flies over the cone of confusion?
 - a. Temporarily follows current heading until exiting the cone of confusion
 - b. VOR disengages and Heading hold engages
 - c. The pilot must select an alternate roll mode
 - d. The pilot manually flies the aircraft following flight director roll commands.

16. The autopilot disconnects (or the autoland is completed) at:
 - a. 100 ft
 - b. decision height
 - b. flare
 - d. roll out

17. The control law in a fly-by-wire system is a relationship between:
 - a. how the pilot's control demands are translated into control surface movements.
 - b. input and output at the amplifier level respectively control the deviation data
 - c. computer input deviation data and flap position modification
 - d. the versine signal between the ailerons and elevators

18. What are the autopilot minimum requirements in order to fly single pilot operations in IFR conditions or at night?
 - a. Two axis autopilot with altitude hold and heading hold.
 - b. Two axis autopilot with altitude hold, heading hold, VOR tracking and Alt acquire
 - c. Single axis autopilot with Altitude hold only
 - d. Single axis autopilot with Heading select and VS

19. When flying level in the cruise the holds height and the holds the speed:

a	Autopilot,	Autopilot
b	Auto-throttle,	Auto-throttle
c	Auto-throttle,	Autopilot
d	Autopilot,	Auto-throttle

20. At what height during a semi-automatic landing is the autopilot disengaged:
 - a. 100 ft
 - b. 45 ft
 - c. Decision height
 - d. 14 ft

21. At the missed approach point the TOGA switch on the throttles is depressed. Which of the following statements are correct:
1. Autopilot selects max. power
 2. GA power selected
 3. Aircraft automatically cleans up
 4. Autopilot fly's the GA manoeuvre
 5. Pilot manually fly's manoeuvre
- a 2 & 5
b 1 & 5
c 1 & 4
d 2 & 4
22. If a Go-Around is initiated from an auto-approach:
1. the autothrottle selects maximum power as soon as the TOGA switch is pressed
 2. the autopilot monitors the climb
 3. the autopilot retracts flap and landing gear to reduce drag
 4. the pilot performs the climb
 5. the pilot retracts the flap and landing gear to reduce drag
- a. 1, 2 & 4
b. 1, 4 & 5
c. 1, 3 & 4
d. 1, 2 & 3
23. An auto-land system which can continue to automatically land the aircraft after a single failure is called:
- a. Fail passive
b. Fail Soft
c. Fail Safe
d. Fail active
24. Where can the pilot look to see the autothrottle mode?
- a. PFD
b. overhead panel
c. throttle control panel
a. EICAS
25. Where can the pilot look to see the thrust limit mode?
- a. PFD
b. Overhead panel
c. Throttle control panel
d. Primary EICAS

- 26 The autopilot is engaged with no modes selected. What is the autopilot providing:
- wing leveling
 - altitude hold
 - Auto-stability with auto-trim
 - LNAV and VNAV
- 27 When is an Autoland procedure complete
- At the markers
 - At the beginning of the ground roll
 - At decision height
 - At the flare
- 28 During a CAT2 approach, what is providing the height information
- Capsule stack
 - Radio Altimeter
 - Captain's barometric altimeter
 - Central Air Data Computer
- 29 Autoland Flare is initiated at
- 1500 ft
 - 330 ft
 - 50 ft
 - 5 ft
- 30 An autopilot capable of altitude hold and heading hold is a minimum requirement for:
- Single pilot operation in VMC and IMC.
 - Single pilot operation under IFR and at night.
 - Aircraft over 5700kg.
 - Dual pilot operation (in IFR).
- 31 During a fully automatic landing the autopilot:
- and the auto-throttle control the approach at least until the flare.
 - and the auto-throttle control the approach at least until the roll-out.
 - and the auto-throttle control the approach at least until decision height.
 - controls the approach (at least) until the roll-out, the pilot controls the power.
- 32 A landing is considered to be Automatic when:
- autopilot flies the ILS to Decision Height, and then disengages
 - autothrottle maintains speed until Decision Height, and then disengages
 - autothrottle disengages thrust at 50ft
 - autopilot flies the ILS until the flare
 - the flare is automatic
- 2, 3 & 5
 - 1 & 2
 - 4 & 5
 - 1 & 4

- 33 In an autopilot system, modes for stabilising the a/c include which of the following:
- 1 Yaw damper.
 - 2 Pitch attitude holding.
 - 3 VOR axis holding.
 - 4 ASI & Mach hold.
 - 5 Horizontal wing holding.
 - 6 Altitude holding.
- a. 1, 2 & 4
 - b. 1, 2 & 5
 - c. 1, 5 & 6
 - d. 2, 4 & 6
- 34 In an autopilot system, a/c flight path modes include which of the following:
- 1 Pitch attitude holding.
 - 2 Horizontal wing holding.
 - 3 VOR axis holding.
 - 4 Inertial heading holding.
 - 5 ASI & Mach hold.
 - 6 Yaw damper.
- a. 1, 2 & 4
 - b. 1, 2 & 5
 - c. 2, 4 & 6
 - d. 3, 4 & 5
- 35 Auto-throttle can hold which of the following:
- 1 Speed.
 - 2 Mach No.
 - 3 Altitude.
 - 4 N_1 /EPR.
 - 5 VOR capture.
 - 6 Vertical profile.
- a. 1, 2 & 3
 - b. 1, 2 & 4
 - c. 1, 2 & 6
 - d. 1, 3 & 5
- 36 An autopilot system whereby if one A/P fails cannot carry out an auto-land is called fail_____:
- a. passive.
 - b. safe.
 - c. operational.
 - d. redundant.
- 37 In a yaw damper:
- a. ailerons are moved in proportion to Mach No.
 - b. ailerons are moved in proportion to rate of angular velocity.
 - c. rudder is moved in proportion to Mach No.
 - d. rudder is moved in proportion to rate of angular velocity.

- 38 "LOC ARMED" lights up on the annunciator, this means:
- localiser beam captured.
 - localiser armed and awaiting capture.
 - localiser alarm is on.
 - ILS is captured
- 39 What is the most basic function of an autopilot?
- altitude hold
 - heading hold
 - wing leveller
 - altitude and heading hold
- 40 What does the autopilot pitch / rotate around?
- centre of gravity
 - manoeuvre point
 - centre of pressure
 - neutral point
- 41 During a semi-automatic landing
- the A/P is disengaged at DH having followed the ILS.
 - the A/T flies airspeed down to approximately 30 ft and automatically disengages.
 - the A/P flies the approach and flare and roll-out.
 - the A/T flies approach speed and disengages automatically at DH
- 42 If only a single A/P is used to climb, cruise and approach; following a failure:
- it is fail passive with redundancy.
 - it is fail operational and will not disconnect.
 - it is fail soft and will not disconnect.
 - it is fail safe and will disconnect.
- 43 In heading select the autopilot delivers roll commands to the controls to bank the aircraft:
- 1 proportional to TAS, but not beyond a specified maximum.
 - 2 Set bank of 27 degrees.
 - 3 Set bank of 15 degrees.
 - 4 Proportional to the deviation from the selected heading.
- 1&2
 - 2&3
 - 3&4
 - 4&1

- 44 Regarding autopilot and auto-throttle:
- 1 A/P holds IAS/MACH when climbing in LVL CHG and A/T controls thrust.
 - 2 A/P holds altitude in cruise with ALT HOLD, A/T controls IAS/Mach.
 - 3 A/P holds pitch in descent in V/S mode, A/T controls thrust.
 - 4 A/P holds alt in climb mode, A/T controls IAS/Mach in speed.
- a. 1 & 2
 - b. 3 & 4
 - c. 1, 2 & 3
 - d. 2, 3 & 4
- 45 Auto-trim is fitted to an autopilot:
- a. To provide control about lateral axis.
 - b. To prevent snatching on disengaging A/P.
 - c. To prevent snatching on engaging A/P
 - d. To correct for Mach tuck
- 46 Auto throttle can hold
1. speed
 2. flight path
 3. altitude
 4. Mach
 5. EPR / N_1
 6. attitude
- a. 1, 2, 6
 - b. 1, 4, 5
 - c. 1, 2, 3, 4
 - d. 3, 4, 5
47. What is the purpose of the synchronisation in an autopilot.(list)
1. Prevents snatch on disengagement.
 2. Prevents snatch on engagement.
 3. Cancels rudder control inputs.
 4. May not allow the autopilot to engage if unserviceable.
- a. 1 & 2
 - b. 1 & 3
 - c. 2 & 4
 - d. 3 & 4
48. When operating with the autopilot in ALT hold mode what happens if the Captain's barometric altimeter pressure setting is increased.
- a. ALT hold disengages
 - b. Nothing
 - c. The aeroplane will climb
 - a. The aeroplane will descend

49. TO/GA is engaged
- automatically at GS capture
 - automatically when an autopilot fails
 - by the pilot pressing a button on or near the throttles
 - by the pilot selecting flare
50. On crossing the cone of confusion of a VOR when in VOR mode of the autopilot what will happen to the roll channel.
- Always coupled to the selected VOR radial
 - Temporarily disconnected
 - Damped by a trim input from the lateral trim system
 - Temporarily switches to heading mode
51. The function of autotrim is
- to synchronise the longitudinal loop
 - to relieve forces on the autopilot servomotor prior to hand over
 - to react to altitude changes in ALT HOLD mode
 - to relieve forces on the control column before hand over
52. The Mach Trim system
- compensates for the rearward movement of the CP due to shockwave formation
 - compensates for the forward movement of the CP due to shockwave formation
 - controls the aircraft in roll
 - is operational at low subsonic speeds
53. The Flight Director horizontal and vertical bars are up and left of aircraft symbol on the ADI, these indications are directing the pilot to:
- Increase pitch angle, turn left
 - Decrease pitch angle, turn left
 - Increase pitch angle, turn right
54. What does FADEC do?
- engine limitation protection
 - automatic engine starting sequence
 - manual engine starting sequence
 - power management
- 1 & 2
 - 4 only
 - 1 & 4
 - 1, 2, 3 & 4
55. What does the Mach trim system use to prevent 'Mach Tuck'?
- elevator
 - elevator/rudder
 - rudder
 - elevator/aileron/rudder

- 56 The autosynchronisation system does which of the following?
1. prevents snatching on engagement
 2. prevents snatching on disengagement
 3. cancels rudder input
 4. works in climb, cruise and descent
- a 1&2
b 2&3
c 1&4
d 3& 4
- 57 When turning into a desired radial, FD bars indicate:
- a a 45° angle of bank
 - b a 30° angle of bank
 - c a 15° angle of bank
 - d correct attitude to intercept radial
- 58 If a pilot was to carry out a roll maneuver, on release of CWS what does the AP do?
- a Roll wing level and maintain heading only
 - b Maintain attitude only
 - c Maintain track and attitude only
 - d Roll wing level and maintain MCP selected roll

ANSWERS TO AUTOFLIGHT QUESTIONS

1	A	21	D	41	A
2	A	22	B	42	D
3	B	23	D	43	D
4	B	24	A	44	A
5	B	25	D	45	B
6	C	26	C	46	B
7	A	27	B	47	C
8	B	28	B	48	B
9	A	29	C	49	C
10	C	30	B	50	D
11	A	31	B	51	B
12	B	32	C	52	A
13	D	33	B	53	A
14	D	34	D	54	D
15	A	35	B	55	A
16	D	36	A	56	C
17	A	37	D	57	D
18	A	38	B	58	B
19	D	39	C		
20	C	40	A		

WARNING & RECORDING

- 1 The input to a basic stall warning system are:
 - a Angle of attack
 - b IAS
 - c Slat/flap position
 - d M_{no}

- 2 Where in the aircraft does JAR require the FDR to be fitted:
 - a At the back
 - b At the front
 - c In the wings
 - d In the undercarriage bay

- 3 An FDR fitted to an aircraft of over 5700kgs after Apr 98 must record for:
 - a 10 hours
 - b 25 hours
 - c 30 minutes
 - d 60 minutes

- 4 Where is TCAS displayed?
 1. On its own screen
 2. On the EFIS
 3. Weather Radar
 4. On VSI
 - a. All 4
 - b. 1, 2 & 4
 - c. 2 & 3
 - d. 1 & 4

- 5 The principle that TCAS uses is:
 - a. Primary radar
 - b. ATC radar
 - c. RT communications
 - d. Transponders in the aircraft

6. When an intruder aircraft has no Altitude Reporting facility, i.e. Mode equipped with 'A' transponder only, TCAS can only give:
 - a. Corrective RA only
 - b. TA followed by a Preventative RA
 - c. TA only
 - d. Preventative RA only

7. What does a FDR record when combined with a CVR?
1. Cockpit voice
 2. Radio
 3. Public addresses from the cockpit
 4. Cabin voice
- a. 1, 2 & 3
 - b. 1 & 2
 - c. All 4
 - d. 2 & 4
8. A GPWS system requires:
- a. Light & bell
 - b. Aural signals only
 - c. Aural signals which may be supplemented by visual signals
 - d. Aural, tactile and visual signals or a combination thereof
9. The Altitude Alert system alerts the pilot:
- a. At decision height
 - b. At the selected altitude
 - c. When reference altitude equals the selected altitude
 - d. When deviating from the selected altitude
10. The Altitude Alert system :
- a. May alert by visual signals when approaching the selected altitude
 - b. Activates a warning light on reaching selected altitude
 - c. Engages autotrim on reaching selected altitude
 - d. Disengages autotrim on reaching selected altitude
11. TCAS II obtains information from:
1. Pressure encoding from mode S transponder
 2. Radio altimeter
 3. Aircraft specific configurations
 4. Inertial reference unit (IRU)
- a. 1, & 2
 - a. 1, 2, & 4
 - b. 1, 2, 3, & 4
 - c. 1, 2, & 3
12. What does a CVR record?
- a. Cabin crew conversations
 - b. Cabin crew conversation on intercom
 - c. PA announcements even when not selected on flight deck
 - d. Radio conversations

- 13 A stall warning system fitted to a large aircraft will always include:
- a Various inputs including speed brake position, a warning module and a visual or aural warning
 - b Various inputs including landing gear micro switch, a warning module and an aural warning
 - c Various inputs including EGT, a warning module and an aural warning
 - d Stick shakers and/or stick push
- 14 GPWS is active between what heights:
- a. 0ft and 2500ft
 - b. 50ft and 2450 ft
 - c. 0 ft and 2450 ft
 - d. 50 ft and 5000 ft
- 15 What is the correct response to a TCAS RA?
- a. Smoothly and immediately follow the climb or descent commands
 - b. Request permission to manoeuvre from ATC
 - c. Follow ATC instructions as these override TCAS RAs
 - d. Turn 90° and smoothly and immediately follow the climb or descent commands
- 16 What symbol is used to represent a RA on a TCAS PPI?
- a. Yellow circle
 - b. Red lozenge
 - c. Red square
 - d. Red circle
- 17 Which of the following is a preventative RA?
- a. Monitor vertical speed
 - b. Turn left
 - c. Traffic, traffic
 - d. Climb, climb now
- 18 What input is there to TCAS 2?
- a Mode 'A' transponder which gives TA and RAs
 - b Mode 'C' transponder which co-ordinates avoidance manoeuvres
 - c Mode 'C' and 'S' transponders which co-ordinate avoidance manoeuvres
 - d Mode 'S' transponder which co-ordinates avoidance manoeuvres
- 19 An aircraft registered after the 1 April 1998 requires a CVR which:
- a. Records the last 2 hours of flight
 - b. Records the last 72 hours of flight
 - c. Records the last 30 minutes of flight
 - d. Records the last 8 hours of flight

- 20 What are the JAR OPS requirements for the CVR to start and stop recording?
- From the time when the aircraft is first able to move under its own power until it is no longer able to do so.
 - From the time the first engine is started and stops 5 minutes after the last engine is shutdown.
 - From the time when the first engine is started and stops 5 minutes after the APU is shutdown.
 - From the time when the aircraft is first able to move under its own power until 5 minutes after it is no longer able to do so.
- 21 An altitude alerting system must at least be capable of alerting the crew on:
- Approaching selected altitude.
 - Excessive deviation from selected altitude.
 - Excessive vertical speed.
 - Excessive terrain closure.
 - Abnormal gear/flap combination.
- 1&2.
 - 1,2,3&4.
 - 1,2,3,4&5.
 - 1,2&3.
- 22 An aircraft that weights more than 5,700 kg and was registered after 1 April 1998, the FDR and CVR must record respectively:
- 25 hr. and 1 hr.
 - 25 hr. and 2 hr.
 - 10 hr. and 2 hr.
 - 10 hr. and 1hr.
- 23 "Other traffic" which is assessed as not being a threat will be indicated by a TCAS system as:
- A solid red square.
 - A solid white or cyan diamond.
 - A hollow cyan diamond.
 - A hollow cyan square.
- 24 Which of the following are modes of the GPWS?
- Excessive sink rate.
 - Altitude loss after T/O or go-around.
 - Excessive Glideslope deviation.
 - High climb rate.
 - Flaps in incorrect position.
 - High altitude descent.
 - Stall.
- All 7
 - 1, 2, 3, & 5
 - 1, 2 & 3
 - 1, 3, 5 & 7

25. What corrective action is given by TCAS?
- a Turn left or right.
 - b Climb or descend.
 - c Contact ATC
 - d Turn then climb or descend.
26. The Flight Data Recorder actually starts running:
- a At the beginning of the T/O run.
 - b Before the a/c starts moving under its own power
 - c When the gear is retracted.
 - d When a/c lines up on runway.
27. GPWS may indicate (list):
- 1. Excessive sink rate after T/O.
 - 2. Excessive descent rate.
 - 3. Excessive closure with terrain.
 - 4. Ground proximity not in the landing configuration.
 - 5. Excessive glide-slope deviation.
 - 6. Altitude call-outs.
 - 7. Bank Angle alerting.
- a 1, 4, 5 & 7
 - b All 7
 - c 1, 2 & 3
 - a 1, 3, 6 & 7
28. TCAS 2 when fitted with mode C transponder may give:
- a TA only.
 - b TA and RA in horizontal plane.
 - c TA and RA in vertical plane.
 - d RA only.
29. According to JAR OPS when must the CVR on a 50 seat turbo prop a/c begin recording?
- a Switch on to switch off.
 - b From lift off to when the weight on wheels switch is made on landing.
 - c From before the a/c is capable of moving under its own power to after the a/c is no longer capable of moving under its own power.
 - d At commencement of the taxi to turning off the runway.
30. What is the GPWS Mode 3 audible alert?
- a DON'T SINK, DON'T SINK followed by WHOOP WHOOP, PULL UP if the sink rate exceeds a certain value.
 - b DON'T SINK, DON'T SINK continuously.
 - c DON'T SINK, DON'T SINK followed immediately by WHOOP WHOOP, PULL UP.
 - d SINK RATE repeated each 1.5 seconds. Penetrating the second boundary generates an aural alert of WHOOP, WHOOP PULL UP.

31. CVR components consist of:
- 1 Microphone
 - 2 Crash/Fire resistant construction
 - 3 Independent battery
 - 4 A Flight data recorder
- a 1 & 2
b 1 & 4
c 1, 2, 3 & 4
d 1, 2 & 4
32. If an aircraft GPWS detects an excessive rate of descent with gear and flaps up, the alert and warning will be :
- a DON'T SINK, DON'T SINK
b TOO LOW TERRAIN, TOO LOW TERRAIN followed by TOO LOW GEAR TOO, LOW GEAR
c SINK RATE followed by 'WHOOOP WHOOP PULL UP
d TERRAIN TERRAIN followed by 'WHOOOP WHOOP PULL UP
33. The requirement to carry a GPWS concerns aircraft which are, depending on their age, weight and passenger capacity
1. Turbo prop 2. Piston 3. Jet
- a 1, 2 & 3
b 1, 3
c 3
d 1

ANSWERS TO WARNING & RECORDING QUESTIONS

1	A	21	A
2	A	22	B
3	B	23	C
4	A	24	B
5	D	25	B
6	C	26	B
7	A	27	B
8	C	28	C
9	D	29	C
10	A	30	B
11	C	31	A
12	D	32	C
13	B	33	B
14	B		
15	A		
16	C		
17	A		
18	D		
19	A		
20	A		

ENGINE INSTRUMENTS

1. What type of sensor is used to measure the output of a low pressure booster pump
 - a. bourdon tube
 - b. aneroid capsule
 - c. bellows
 - d. differential capsule

 2. A vibration meter measures
 - a. frequency in Hz
 - b. amplitude at a given frequency
 - c. period in seconds
 - d. acceleration in g

 3. Which of the following are used to measure temperature
 1. thermocouple
 2. resistance
 3. reactance
 4. mercury
 - a. 1,2,3,4
 - b. 1,2, & 4
 - c. 2,3, & 4
 - d. 1,3,& 4

 4. A millivoltmeter measuring electromotive force between a hot and a cold junction of a thermocouple can be graduated to read temperature if: -
 - a. the hot junction is kept at a constant temperature
 - b. the cold junction is maintained at 15 degrees C.
 - c. the hot junction is maintained at 15 degrees C.
 - d. the cold junction is maintained at a constant temperature

 5. If both displays of an EICAS system fail what information will be displayed on the standby engine indicator
 - a. N1,EPR,N2
 - b. N1,EPR, EGT
 - c. N2,EPR, EGT
 - d. EGT,N1, FF

 6. A capacitive type gauging system may measure mass due to:
 - a. fuel dielectric constant being equal to that of air and proportional to density
 - b. fuel dielectric constant being equal to that of air and proportional to $1/\rho$ density
 - c. fuel dielectric constant being twice that of air and proportional to density
 - d. fuel dielectric constant being twice that of air and proportional to $1/\rho$ density
-

7. If the intake probe of an EPR system becomes blocked with ice this will cause the EPR gauge to
- under-read during take off
 - over-read during take off
 - be unaffected
 - read zero
8. The power output of a turbo-propeller aircraft is measured by the amount of torque being produced. The indication can be in which of the following units.
1. Newton metres
 2. PSI
 3. Percentage
 4. Pounds feet
 5. EPR
- 1,2,3,4,5
 - 1,2,3,5
 - 2,3,4,5
 - 1,2,3,4
9. If one probe of a multi-sensor T.G.T. system failed , the reading would:
- increase by 20 – 30 degrees C
 - decrease by 20 – 30 degrees C
 - be practically unaffected
 - fall to zero.
10. During the take-off run , the effect of increasing airspeed is to cause the EPR indication to :
- remain constant
 - increase
 - decrease
 - increase and subsequently decrease
11. An advisory message on the EICAS system screen would be:
- displayed in amber on the lower screen with associated caution lights and aural tones
 - displayed in red, normally on the upper screen , and requiring immediate corrective action
 - displayed in amber, normally on the upper screen with aural warnings .
 - displayed in amber, normally on the upper screen, indented one space to the right.
12. A supercharged aircraft is climbing at its maximum permitted boost of 8 psi (16in.Hg) from sea level to its full throttle height of 10,000 feet. If sea level pressure is 29.92in.Hg , when the aircraft reaches 5000 feet, where the pressure is 24.72in.Hg, what will be the approximate indication on the MAP gauge.
- 18 in Hg
 - 33 in Hg
 - 41 in Hg
 - 46 in Hg

13. An aircraft has a compensated capacitance fuel contents gauging system and is refuelled so that the total fuel contents are 76000kg at a temperature of 18 degrees C and an S.G. of 0.81. Whilst the aircraft is parked the temperature increases to 26 degrees C and the S.G. becomes 0.80. The indicated fuel contents have:
- increased by 5%
 - increased by 10%
 - decreased by 5%
 - remained the same
14. The working principle of a capacitive fuel contents gauging system is based upon
- volume of fuel
 - changes in capacitance
 - height of fuel
 - dielectric value
15. A volumetric fuel flow meter is different to a mass flow meter because the mass flow meter compensates for:
- dielectric
 - density
 - volume
 - pressure
16. Cylinder head temperature measurement works on the principle of
- differential expansion
 - wheatstone bridge
 - ratiometer
 - thermocouple
17. The electrical tacho generator system uses
- single phase a.c. whose frequency varies with the speed of the engine delivered to a single phase synchronous motor and drag cup.
 - three phase a.c. whose frequency varies with the speed of the engine delivered to a three phase synchronous motor (squirrel cage) and drag cup.
 - A tacho probe and phonic wheel measuring speed and sending information to a squirrel cage motor and drag cup
 - Single phase d.c. whose frequency varies with speed of the engine converted to a square wave pulse delivered to a servo driven instrument
18. Where very accurate temperature indication is required the indicator used will be:
- galvanometer
 - direct reading
 - moving coil
 - ratiometer

19. Total Air Temperature (TAT) is equal to:
- SAT + ram rise
 - RAT + friction rise
 - SAT – RAT
 - RAT + ram rise
20. The principle of the fuel-monitoring device giving the fuel burnt is:
- multiplying flight time by fuel consumption
 - capacitance variation of a capacitor
 - difference of indication according to departure value
 - integration of instantaneous flow

21. To measure the fuel quantity on a heavy aircraft we use:
- capacitor gauges
 - electric gauges with round floats
 - the indication can directly be indicated as a mass
 - the indication can not be indicated as a mass

The combination of all correct statements is:

- 1,4
 - 2,3
 - 2,4
 - 1,3
22. For a capacitor gauge:
- the fuel dielectric value is half that of air
 - the fuel dielectric value varies proportionally to the temperature of the fuel
 - the probes are connected in parallel
 - fuel dielectric value varies inversely with the fuel level
 - the gauge accuracy is within 2%

The correct statements are:

- 3,5
 - 2,3
 - 3,4
 - 1,2
23. The capacitor gauge principle is based on:
- variation of capacitance of a capacitor with the nature of the dielectric
 - variation of capacitance by volume measure at the probe
 - variation of the EMF in a wheastone bridge
 - variation of outflow and couple in the system

24. Among the following parameters:

EGT
EPR
FF
N1
N2
Oil pressure
Fuel pressure

The ones that can be used to monitor a gas turbine thrust setting are:

- a. EGT, N1, N2, oil pressure
 - b. EGT, N1, FF, EPR
 - c. EGT, EPR, FF, High-pressure fuel
 - d. fuel pressure, N1, N2, oil pressure
25. The most significant parameters and the most important that express the thrust of a gas turbine engine are;
- a. EGT or N2
 - b. N2 and FF
 - c. FF and EGT
 - d. N₁ and EPR
26. On a modern twin spool turbofan, the main handling parameter is:
- a. the temperature upstream the turbine or EGT
 - b. a rotational speed and a temperature
 - c. the rotational speed of the high-pressure compressor
 - d. the rotational speed of the low-pressure compressor
27. Two main indications used to evaluate a turbojet thrust are:
- a. rotational speed of the fan (N₁) or the total pressure at the outlet of the low-pressure turbine
 - b. fan rotational speed (N₁) or total pressure at the high-pressure compressor outlet
 - c. fan rotational speed (N₁) or EPR
 - e) high pressure turbine rotational speed or EPR
28. The measure of a torque can be made by measuring:
- a. oil pressure at a fixed crown of an epicyclical reduction gear of the transmission box
 - b. the amount of light through a gear linked to a transmission shaft
 - c. the frequency of a phonic wheel linked to a transmission shaft
 - d. the frequency difference between two phonic wheels linked to a transmission shaft
29. Among these instruments, which one uses aneroid capsules?
- a. oil thermometer
 - b. air intake pressure sensor
 - c. oil pressure sensor
 - d. fuel pressure sensor

30. In a three phase tachometer installation:
- 1 the transmitter is a DC generator
 - 2 we measure an EMF proportional to the driving speed of the transmitter
 - 3 we measure a frequency proportional to the driving speed of the transmitter
 - 4 the receiver is a galvanometer
 - 5 the receiver is an synchronised motor driving a magnetic tachometer

The correct statements are:

- a. 1,2
 - b. 2,5
 - c. 1,4
 - d. 3,5
31. The working principle of mass flow meters mostly used now days, is to measure in their system:
- a. the volume and viscosity of the fuel
 - b. the temperature and pressure of the fuel
 - c. volume mass and dielectric value of fuel
 - d. kinetic energy transmitted
32. The advantage of a ratiometer is
- a. doesn't require an electrical supply
 - b. does not suffer from errors due to variations of supply voltage
 - c. is calibrated at sea level and will be inaccurate at high altitudes
 - d. it requires an ac voltage and therefore has no commutator.
33. What is a synchroscope used for
- a. reducing vibration
 - b. putting the propellers in phase
 - c. allowing the pilot to adjust several engines to the same RPM
 - d. viewing the underside of the aircraft during flight
34. On an EICAS display what does the yellow arc on the temperature gauge signify,
- a. Forbidden operating range
 - b. Exceptional operating range
 - c. Normal operating range
 - d. Frequent operating range
35. An RPM gauge has a red line at the upper end of the green arc, in the middle of the green arc is a smaller red arc. What is the significance of this smaller red arc
- a. it indicates an RPM that must not be used continuously because of the increased vibration level from the engine/propeller
 - b. it is maximum continuous RPM
 - c. it is the RPM at which there is an increased likelihood of oil leakage
 - d. it indicates an RPM that must not be used continuously because there is insufficient cooling air for the engine

36. In an ECAM system if a caution message appears the system will
- illuminate the page number that requires to be selected
 - display a diagrammatic view of the affected system
 - will alert the pilot by an audible warning only
 - will cause the relevant buttons to light up
37. A cylinder head temperature measuring system in a piston engine has a sensor
- One in each cylinder head to average the temperature
 - One in the coolest running cylinder
 - One in the hottest running cylinder
 - One in each of the two banks of cylinders in a horizontally opposed engine.
38. The principles used in an electrical RPM indicating system are:-
- Tacho probe and phonic wheel
 - DC generator producing AC
 - 3 phase AC generator driving a 3 phase AC motor
 - Single phase AC generator driving a single phase AC motor
- 1 and 4
 - 1 and 3
 - 2 and 3
 - 2 and 4
39. What does the yellow band on an EICAS generated engine gauge indicate?
- Precautionary operating range
 - Maximum operating range
 - Warning limit
 - Normal range
40. Advantage of a ratiometer type measuring circuit is
- Very Accurate
 - Simple
 - Changes indication if voltage changes
 - No external power supply is required
41. In a Turbojet thrust is measured by
- Fan Speed (N1) and Turbine Inlet Pressure
 - N1 and EPR
 - Compressor outlet pressure and jet pipe pressure
 - Compressor inlet pressure and combustion chamber pressure
42. How will a system failure warning be shown to the pilot in the ECAM system
- The failure will appear as a wording on the screen
 - The master warning caption will illuminate and the pilot will manually select failure mode
 - The master warning will illuminate and the primary screen will display a check list while the secondary shows a graphical display of the problem
 - The Engine parameter displays will be replaced by the Flight Mode screen.

43. What is used to measure gas turbine inlet pressure
- Bourdon Tube
 - Differential capsule
 - Aneroid capsule
 - Bellows
44. What does a bourdon tube measure
- Temperature
 - Quantity
 - Capacitance
 - Pressure
45. What are the disadvantages of an electrical float fuel quantity measuring system
- Attitude
 - Acceleration
 - Temperature
 - Ambient pressure
 - Needs an AC power supply
- 1,2,3,4,5
 - 1,2,3
 - 1,2,5
 - 2,3,4,5
46. How can temperature be measured
- Resistance
 - Mercury
 - Thermocouple
 - Reactance
- 1,2,3,4
 - 1,2,4
 - 1,2,3
 - 1,3,4
47. A Thermocouple would normally be used to measure the temperature of the:
- Turbine
 - Exterior
 - Cabin
 - Oil
48. The Bourdon Tube is used in:
- Temperature probes in front of the engine
 - Smoke detectors
 - Pressure measurement
 - Vibration detectors

- 49 The principle upon which flowmeters (mass flow) most commonly used today work, is to measure:
- a. The Volume and Viscosity of the fuel
 - b. The Pressure and Temperature of the fuel
 - c. Density and Dielectric constant of the fuel
 - d. The Kinetic energy transferred
- 50 A small turbine placed in the flow of fuel to the burners of a Gas Turbine engine measures:
- a. Volume of flow by the measurement of magnetic impulses
 - b. Mass flow by the measurement of magnetic impulses
 - c. Mass flow by the measurement of frequency
 - d. Volume flow by the measurement of reactance
- 51 The torquemeter is an instrument:
- a. Allowing automatic synchronisation of the engines
 - b. Giving the power available by the engine
 - c. Giving the power from the propeller by direct reading
 - d. Allowing the determination of the power from the propeller by using a formula which is a function of the RPM
- 52 Torque can be calculated in a torquemeter system by the measurement:
- a. Of the oil pressure resisting lateral movement of the gearing in an epicyclic reduction gearbox
 - b. Of the amount of light through a gear wheel connected to the transmission
 - c. Of the frequency of a phonic wheel connected to the planet gears of an epicyclic gearbox
 - d. Of the difference between 2 phonic wheels connected to the transmission

ANSWERS TO ENGINE INSTRUMENTS QUESTIONS

1	C	16	D	31	D	46	C
2	B	17	B	32	B	47	A
3	B	18	D	33	C	48	C
4	D	19	A	34	B	49	D
5	B	20	D	35	A	50	A
6	C	21	D	36	B	51	D
7	B	22	A	37	C	52	A
8	D	23	A	38	B		
9	C	24	B	39	A		
10	C	25	D	40	A		
11	D	26	D	41	B		
12	D	27	C	42	C		
13	D	28	A	43	D		
14	B	29	B	44	D		
15	B	30	D	45	B		

SPECIMEN QUESTIONS

- 1 A modern Radio Altimeter uses the frequency band:
 - a VHF 30 - 300 Mhz
 - b SHF 3000 Mhz - 30 Ghz
 - c UHF 300 Mhz - 3 Ghz
 - d HF 3 Mhz - 30 Mhz

 - 2 An aircraft that is assessed as not being a threat would be indicated on a TCAS system as:
 - a a solid red square
 - b a solid white or cyan diamond
 - c a hollow white or cyan diamond
 - d a solid yellow circle

 - 3 During descent through a block of airspace of constant temperature and while flying at a constant mach no will cause the CAS to:
 - a increase
 - b decrease
 - c remain constant
 - d increase at a rate of $1.98^{\circ}/1000$ ft

 - 4 The true altitude of an aircraft in flight is shown from:
 - a the standard atmosphere
 - b pressure altitude
 - c density altitude
 - d temperature altitude

 - 5 On a Turn and Slip indicator, needle to the left and ball to the right indicates:
 - a right turn not enough bank
 - b left turn too much bank
 - c left turn not enough bank
 - d right turn too much bank

 - 6 What is Density Altitude?
 - a temperature altitude
 - b pressure altitude corrected for the prevailing temperature
 - c the altitude in the International Standard Atmosphere at which the prevailing density would be found
 - d pressure altitude corrected for Total Air Temperature

 - 7 A Radio Altimeter is:
 - a ground based and measures true altitude
 - b ground based and measures true height
 - c aircraft based and measures true altitude
 - d aircraft based and measures true height
-

- 8 Which of the following are modes of the GPWS?
- i excessive sink rate
 - ii altitude loss after take-off or go-around
 - iii excessive glideslope deviation
 - iv high climb rate
 - v flaps in the incorrect position
 - vi high altitude descent
 - vii stall
- a i ii iii v
 - b ii iii v vii
 - c i ii iii vii
 - d iii iv v vi
- 9 An aircraft is travelling at 120 kt, what angle of bank would be required for a rate one turn?
- a 30°
 - b 12°
 - c 19°
 - d 35°
- 10 An aircraft is travelling at 100 kt forward speed on a 3° glideslope. What is its rate of descent?
- a 500 ft/min
 - b 300 ft/min
 - c 250 ft/min
 - d 500 ft/sec
- 11 What correction is given by TCAS?
- a turn left or right
 - b climb or descend
 - c contact ATC on receipt of a Resolution Advisory
 - d climb or descend at 500 ft/min
- 12 If the Total Pressure sensor supply line leaks, and with the drain element blocked, in a non-pressurised aircraft this will cause the ASI to:
- a under - read
 - b over - read
 - c over - read in the climb and under - read in the descent
 - d under - read in the climb and over - read in the descent
- 13 Using a Classic Attitude Indicator, an aircraft performs a turn through 270° at a constant angle of bank and rate of turn. The indication is:
- a nose up bank right
 - b nose up bank left
 - c nose up wings level
 - d bank and pitch correct

- 14 The needle and ball of a Turn Indicator are both to the left of the datum. This indicates:
- a a left turn with too much bank
 - b a left turn with too little bank
 - c a right turn with too little bank
 - d a right turn with too much bank
- 15 Under conditions determined by the International Standard Atmosphere, at MSL True Air Speed is:
- a greater than CAS
 - b less than CAS
 - c equals CAS
 - d is indeterminate due to the variation in temperature
- 16 In what range is GPWS operative?
- a 2450 - 0 ft
 - b 3000 - 50 ft
 - c 2450 - 50 ft
 - d 3000 - 0 ft
- 17 Which of the following are inputs to the central processing unit of the GPWS?
- i flaps
 - ii landing gear
 - iii glideslope
 - iv unusual attitudes
 - v radio altimeter
 - vi VOR
- a i ii vi
 - b i ii iii v
 - c i ii iv v
 - d i ii iii v vi
- 18 What is another name for fail active?
- a fail soft
 - b fail operational
 - c fail safe
 - d fail passive
- 19 Why must an autopilot be synchronised when you wish to disconnect?
- a to ensure fail operational landings can continue safely
 - b to allow automatic pitch trimming to reset
 - c to secure against abrupt changes in aircraft attitude
 - d to allow for FD coupling
- 20 What is used for EGT measurement?
- a helical bi-metallic strips
 - b thermistors
 - c radiation pyrometry
 - d thermo emf thermocouples

- 21 When accelerating on a northerly heading what does the Direct Reading Magnetic Compass indicate?
- a no change
 - b north
 - c a turn to the west
 - d a turn to the east
- 22 Why is there a vibration device in a pressure altimeter?
- i to prevent hysteresis
 - ii to prevent lag in a mechanical system
 - iii to keep pilots happy during long flights
 - iv to prevent icing
 - v to overcome dither
- a i ii iv
 - b i ii
 - c ii iii v
 - d i ii iii
- 23 What does the white arc on a temperature scale indicate?
- a never exceed
 - b maximum start and acceleration temperature
 - c normal operating temperature
 - d minimum temperature
- 24 The rate of turn indicator is a very useful gyroscopic instrument. When used in conjunction with the Attitude Indicator it provides:
- a angle of bank
 - b rate of turn about the yaw axis
 - c rate of climb
 - d rate of turn athwartships
- 25 With the aircraft weight constant but variations in airfield altitude, take-off will always be at a constant:
- a equivalent airspeed
 - b calibrated airspeed
 - c groundspeed
 - d true air speed
- 26 An inertial reference system is aligned when turned on so as to:
- a calculate the computed trihedron with reference to the earth
 - b establish true and magnetic north
 - c establish position relative to true and magnetic north
 - d establish magnetic north

- 27 Total Air Temperature is _____ than static air temperature and the difference varies with _____
- a warmer altitude
 - b colder altitude
 - c warmer CAS
 - d colder CAS
- 28 True heading can be converted into magnetic heading using a compass and:
- a a map with isogonal lines
 - b a map with isoclinal lines
 - c a map with isobars
 - d a deviation card
- 29 An aircraft flies into a colder airmass. This will cause the altimeter to:
- a over-read
 - b under-read
 - c read the correct altitude
 - d the indication will depend on the hemisphere of operation
- 30 A gravity-erecting device is utilised in:
- a an artificial horizon
 - b a directional gyroscopic indicator
 - c vertical speed indicator
 - d a turn and slip
- 31 The rigidity of a gyroscope can be improved by:
- a increasing the angular momentum and concentrating the mass on the periphery of the rotor
 - b increasing the angular momentum and concentrating the mass at the hub of the rotor
 - c decreasing the angular momentum and concentrating the mass on the periphery of the rotor
 - d decreasing the angular momentum and concentrating the mass at the hub of the rotor
- 32 The outputs of a flux valve are initially sent to:
- a an amplifier
 - b an error detector
 - c a compass card
 - d a feedback loop
- 33 The period of validity of an FMS data base is:
- a 56 days
 - b one week
 - c 28 days
 - d varies depending on the area of operational cover

- 34 An IRS differs from an INS in that it:
- a has a longer spin-up (is not affected by vertical accelerations due to gravity)
 - b has a shorter spin-up time and suffers from laser lock.
 - c does not need to correct for coriolis and central acceleration)
 - d does not experience Schuler errors as accelerometers are strapped down and not rotated by a feedback loop
- 35 In a solid state gyroscope the purpose of the dither motor is to:
- a enhance the acceleration of the gyro at all rotational rates
 - b overcome laser lock
 - c compensate for transport wander
 - d stabilise the laser frequencies
- 36 In an IRS:
- a the accelerometers are strapped down but the platform is gyro-stabilised
 - b the platform is strapped down but the accelerometers are gyro-stabilised
 - c accelerometers and gyros are both gyro-stabilised
 - d accelerometers and gyros are both strapped down
- 37 Which of the following correctly describes the gyroscope of a Rate of Turn Indicator?
- i 1 degree of freedom
 - ii 2 degrees of freedom
 - iii its frame is held by two springs
 - iv its spin axis is parallel to the pitch axis
 - v the spin axis is parallel to the yaw axis
 - vi the spin axis is horizontal
- a i ii
 - b i iv v
 - c i iii v
 - d i iii vi
- 38 A blockage occurs in the ram air source and the drain-hole. The ASI in a non-pressurised aircraft will:
- a read a little low
 - b read a little high
 - c act like an altimeter
 - d freeze at zero

- 39 The errors associated with the Directional Indicator are:
- i earth rate
 - ii transport wander
 - iii banking when pitched up
 - iv annual movement of the poles
 - v mechanical problems
- a i ii iii
b i ii iv v
c i ii iii iv v
d i ii iii v
- 40 A rate integrating gyroscope is used in:
- i inertial attitude system
 - ii automatic flight control systems
 - iii inertial navigation systems
 - iv rate of turn indicators
- a i ii
b i iii
c i iii iv
d i ii iii
- 41 Rate of turn is affected by:
- i aircraft speed
 - ii angle of bank
 - iii aircraft weight
- a i ii
b i iii
c ii iii
d none of the above
- 42 The ability of a gyroscope to indicate aircraft heading is based on it having:
- a one degree of freedom in the vertical axis
 - b two degrees of freedom in the vertical axis
 - c two degrees of freedom in the horizontal
 - d one degree of freedom in the horizontal
- 43 A V_{mo}/M_{mo} alerting system contains a barometric aneroid capsule:
- a which is subjected to dynamic pressure and an airspeed capsule which is subjected to static pressure
 - b and an airspeed capsule subjected to static pressure
 - c and an airspeed capsule subjected to dynamic pressure
 - d which is subjected to static pressure and an airspeed capsule which is subjected to dynamic pressure

- 44 When measuring different pressures (low/med/high) which of the following has the three types of sensing devices in ascending order of pressure measurement?
- i bourdon tube
 - ii bellows type
 - iii aneroid capsule
- a i ii iii
 - b iii ii i
 - c i iii ii
 - d ii iii i
- 45 Sound is propagated at a velocity which is dependent upon:
- a barometric pressure
 - b density
 - c static pressure
 - d temperature
- 46 The local speed of sound at mean sea level at ISA -10°C is:
- a 661 kt
 - b 650 kt
 - c 673 kt
 - d 680 kt
- 47 What would the compass heading be given a true heading of 247° in an area where the variation is 8°W and a compass deviation of 11°E ?
- a 255°
 - b 244°
 - c 247°
 - d 266°
- 48 An aircraft is flying at flight level 350 at a CAS of 290 kt and a temperature deviation of ISA -10°C . The TAS and MN will be:
- a TAS 498 kt Mach 0.885
 - b TAS 520 kt Mach 0.882
 - c TAS 481 kt Mach 0.855
 - d TAS 507 kt Mach 0.86
- 49 An aircraft in the northern hemisphere lands and decelerates on a westerly heading. The compass will indicate:
- a a turn north
 - b no turn will be indicated
 - c an oscillation
 - d a turn south
- 50 A compass swing is used to:
- a align compass north with magnetic north
 - b align compass north with true north
 - c align magnetic north with true north
 - d get true north and the lubber line aligned

- 51 The angle formed between the directive force and the total magnetic force is called:
- a variation
 - b deviation
 - c dip
 - d isoclinal
- 52 What is the speed of sound at 30,000 ft and -40°C?
- a 562 kt
 - b 595 kt
 - c 590 kt
 - d 661 kt
- 53 If a constant CAS is maintained under normal conditions in the climb what happens to the Mach No?
- a it will decrease
 - b it will remain constant
 - c it will decrease in an isothermal layer
 - d it will increase
- 54 Regarding magnetism; which of the following statements is correct?
- i lines of flux run from blue pole to red pole
 - ii like poles repel
 - iii unlike poles repel
 - iv like poles attract
 - v unlike poles attract
- a i ii v
 - b i iii v
 - c ii v
 - d i iii iv
- 55 The output of a double integration N/S is:
- a velocity
 - b departure
 - c distance
 - d longitude
- 56 A solid state gyro is:
- a a rate gyro
 - b a rate sensor
 - c an earth gyro
 - d a tied gyro
- 57 The magnetic heading reference unit has a precession rate of:
- a 1°/min
 - b 2°/min
 - c 5°/min
 - d 3°/min

- 58 If the TAS at 40,000 ft is 450 kt the Mach No is:
- a 0.815
 - b 0.783
 - c 0.76
 - d 0.825
- 59 The EADI and the EHSI of an EFIS installation are also referred to by the manufacturers as:
- a primary display and navigation display respectively
 - b navigation display and primary display respectively
 - c EICAS and ECAM respectively
 - d ECAM and EICAS respectively
- 60 In which of the following modes may information from the AWR be displayed?
- i plan
 - ii expanded ILS
 - iii map
 - iv full nav
 - v full ILS
 - vi expanded nav
 - vii full VOR
 - viii expanded VOR
 - ix centre map
- a i ii iv vii
 - b i iii vii viii ix
 - c ii iii vi viii ix
 - d ii iii v vii ix
- 61 Wind information can be displayed in an EFIS system in which of the following modes?
- a plan map expanded ILS full VOR
 - b map centre map plan full ILS
 - c full nav full ILS map centre map
 - d full ILS full VOR map plan
- 62 On an EADI radio altitude is displayed:
- a digitally between 2500 ft and 100 ft
 - b on an analogue scale below 2500 ft
 - c digitally between 2500 ft and 1000 ft and thereafter as an analogue/digital display
 - d as an analogue display between 2500 ft and 1000 ft and thereafter as a digital display
- 63 In FMS fitted aircraft the main interface between pilot and system will be provided by:
- a the automatic flight control system
 - b the multi-purpose control and display unit
 - c the flight control unit
 - d the flight management source selector

- 64 In the ILS mode, one dot on the lateral deviation scale on the EHSI indicates:
- a 1 nm
 - b 2nm
 - c 1°
 - d 2°
- 65 On a standard 2-dot EHSI in the en-route mode each dot represents:
- a 1 nm
 - b 2 nm
 - c 5 nm
 - d 10 nm
- 66 Given the following information calculate the instrument error of a pre-flight altimeter check.
- i aerodrome elevation: 235 ft
 - ii apron elevation: 225 ft
 - iii height of altimeter above apron: 20 ft
 - iv altimeter reading with QFE set: 40 ft
- a +20 ft
 - b +30 ft
 - c +40 ft
 - d +10 ft

EXPLANATIONS TO SPECIMEN QUESTIONS

- 1 A modern radio altimeter operates on the principle of a frequency modulated continuous wave in the frequency band 4200 - 4400 MHz. This is the SHF band also referred to as the centimetric (microwave) band of 3 - 30 GHz

Answer B

- 2 The symbols in the answers represent the following:

- a solid red square - Resolution Advisory
- b solid white or cyan diamond (lozenge) - Proximate traffic
- c hollow white or cyan diamond (lozenge) - Other traffic
- d solid yellow circle - Traffic Advisory

Answer C

3

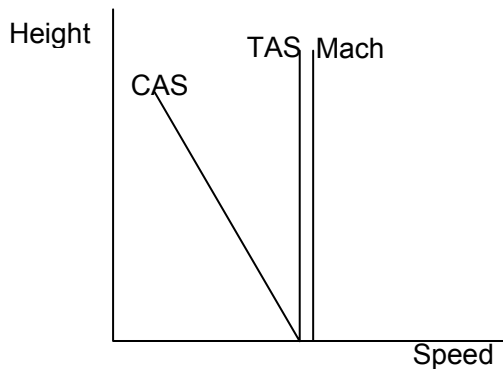

Answer A

- 4 True altitude is the exact vertical distance above mean sea level (AMSL). This differs from the indicated pressure if ambient conditions vary from ISA. True altitude may be calculated from pressure altitude using the navigation computer.

Navigation Computer Method:

Given:

- i indicated pressure altitude - 25,000 ft
- ii ambient temperature -50°C

Method:

- i in the altitude window set pressure altitude of 25,000 ft against the temperature of -50°C.
- ii Against indicated altitude on the inner logarithmic circular scale read off the true altitude of 23,400 ft.

Answer B

- 5 In the answers the needle and ball indicate the following:
- a right turn with skid (insufficient aileron, too much rudder)
 - b left turn with slip (too much aileron, insufficient rudder)
 - c left turn with skid (insufficient aileron, too much rudder)
 - d right turn with slip (too much aileron, insufficient rudder)

Answer B

- 6 Density altitude is defined as "The altitude in the ISA at which the prevailing density would be found".

Density Altitude may be calculated using the navigation computer or by formula.

Example:

- i pressure altitude - 3000 ft
- ii ambient temperature - +20°C

Navigation Computer Method

- i in the airspeed window set the pressure altitude of 3000 ft against the temperature of +20°C.
- ii read the density altitude over the arrow in the density altitude window.
(4000 ft)

Formula Method

- i density altitude = pressure altitude \times (\pm ISA deviation \times 120)
therefore: $3 \times (+11 \times 120)$
 $= 3960$ ft

Note: *If the ambient temperature is lower than ISA then density altitude will be lower than pressure altitude and vice versa.*

Answer C

- 7 Answer D

- 8 Answer A

- 9 The formula to calculate angle of bank for a rate one turn is:
A of B = true airspeed/10 + 7°
therefore: $120/10 + 7^\circ = 19^\circ$

Answer C

- 10 To calculate the rate of descent of an aircraft in feet per minute the Rule of Thumb is:

5 x aircraft groundspeed

therefore: $5 \times 100 = 500$ ft/min rate of descent

Answer A

- 11 TCAS I will issue a Traffic Advisory only. Manoeuvre of the aircraft is prohibited.

TCAS II will issue a Corrective Resolution Advisory instructing the pilot to take corrective action in the vertical plane only.

TCAS III will issue a Corrective Resolution Advisory instructing the pilot to take corrective action in the vertical and/or horizontal planes.

Note: Do not confuse a "Corrective Resolution Advisory" with a "Preventative Resolution Advisory" which only provides limitations on aircraft manoeuvres as opposed to a "Corrective Resolution Advisory" which issues corrective aircraft manoeuvres.

Answer B

- 12 A leak in the total (pitot) pressure line will exhaust a percentage of that pressure to atmosphere causing both the ASI and the mach meter to under read. The loss of pressure will cause the airspeed capsules in both instruments to under - expand.

Answer A

- 13 A Classic Attitude Indicator is referring to an Air Driven Artificial Horizon. During a standard 360° the following indications will be apparent:

		<u>PITCH</u>	<u>ROLL</u>
Roll in:	360°	normal	normal
	90°	high (nose up)	too low
	180°	high (nose up)	normal
	270°	high (nose up)	too high
Roll out:	360°	normal	normal

This error is used by the application of compensation tilt.

Answer A

- 14 See answers to question 6

Answer A

- 15 This can be proved on the navigation computer. Set all parameters for ISA at mean sea level. Read off CAS on the inner scale against TAS on the outer scale. They are the same.

Answer C

- 16 This is based on radio altimeter height above terrain.

Answer C

17 inputs to GPWS are as follows:

- i radio altimeter
- ii vertical speed
- iii ILS glideslope deviation
- iv undercarriage position
- v flap position
- vi mach number

Answer B

18 A system that can withstand at least one failure but leaves the system capable of completing the landing and roll is described as 'fail operational'. An alternative term is 'fail active'.

Answer B

19 The auto-pilot synchronisation system prevents 'snatching' of the flying controls on engagement of the auto-pilot. The auto-trim system adjusts the trim of the aircraft during automatic flight to prevent 'snatching' of the controls on disengagement of the auto-pilot.

Answer C

20 EGT is measured using a number of thermocouples connected in parallel to minimize the effect of failure of one of them.

Answer D

21 Newton' third law: 'to every action there is an equal and opposite reaction'. In this case the forces cancel out and the compass will continue to indicate North.

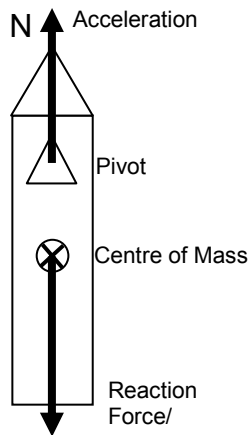

Answer B

22 Answer B

23 Answer C

24 Answer B

25 Answer B

- 26 A trihedron is defined as figure having three sides. Additionally, the IRS establishes True North. Magnetic indications are obtained by the application of variation, which, in the case of the Boeing 737-400 is stored in each IRS memory. The range covered for variation is from 73° North to 60° South latitude.

Answer A

- 27 Total Air Temperature (TAT) is warmer than Static Air Temperature due to the effect of compressibility. The faster the aeroplane flies the greater the TAT.

Answer C

- 28 Isoclinal lines refer to magnetic dip, isobars refer to atmospheric pressure lines on a meteorological chart and a 'deviation card' is a compass correction card positioned along side the compass in the aircraft.

Answer A

- 29 If the actual temperature of the column of air in which the aircraft is flying is COLDER than ISA then the True Altitude of the aircraft above mean sea level will be LOWER than the Indicated Altitude. If the actual temperature is WARMER than ISA the True Altitude will be higher.

Answer A

- 30 The air driven artificial horizon is also known as the 'classic attitude indicator'.

Answer A

- 31 Angular momentum means speed of rotation (RPM).

Answer A

- 32 The error detector is also known as a signal selsyn.

Answer B

- 33 Answer C

- 34 The question refers to a ring laser gyro.

Answer B

- 35 Answer B

- 36 Answer D

- 37 Answer C

- 38 Answer C

- 39 Answer D

- 40 Answer B

- 41 Answer A

- 42 Vertical axis means horizontal plane. The two are at 90° to each other. It follows, therefore, that heading information only requires one degree of freedom in the horizontal plane about the vertical axis of the gyroscope.

Answer A

- 43 Answer D

- 44 Answer B

- 45 $LSS = 38.94 \times \sqrt{\text{temp in } ^\circ\text{K}}$
Or, on the CRP 5

Answer D

- 46 The first thing to remember is that the local speed of sound is dependent on AMBIENT temperature not ISA. In this case, applying the temperature deviation to the ISA temperature at mean sea level gives an ambient temperature of +5°C. There are two methods of calculating the local speed of sound.

The first is to use the formula in question 51 as follows:

$$LSS = 38.94 \times \sqrt{278^\circ\text{K}}$$

$$LSS = 649.26 \text{ kt}$$

The second method is to use the CRP 5 navigation computer as follows:

- i in the airspeed window set the ambient temperature of +5°C against the mach number index.
- ii against 10 on the inner (CAS/Mach number) scale read off the LSS on the outer (TAS) scale. 650 kt

Answer B

- 47 $C \pm D = M \pm V = T$
 $244^\circ + 11^\circ = 255^\circ - 8^\circ = 247^\circ$

Answer B

- 48 On the CRP 5 first calculate the TAS from the information given. Don't forget compressibility! This will give a TAS of 481 kt. Now in the airspeed window set the ambient temperature of -65°C against the mach number index. Against the TAS of 481 on the outer scale read off the mach number on the inner scale, in this case 0.855M.

Answer C

- 49 During a deceleration the direct reading compass will indicate an apparent turn towards the further pole. In the northern hemisphere it will give an apparent turn towards the south whereas in the southern hemisphere it will indicate an apparent turn towards the north. Accelerations are exactly opposite indicating apparent turns towards the nearer pole.

Answer D

- 50 Answer A

51 Variation is the angular difference between True North and Magnetic North

Deviation is the angular difference between Magnetic North and Compass North 'Dip' is the angle formed between the horizontal component (H or Directive Force) of the earth's magnetic field and the Total Magnetic Force (Intensity) of the earth's magnetic field.

An isoclinic is a line joining lines on a chart of equal 'dip'. The aclinic line is a line indicating zero 'dip' and is also referred to as the Magnetic Equator.

Answer C

52 In this question the altitude is of no consequence. Use the same techniques as shown in question 52

Answer B

53 Owing to density error the TAS will increase dramatically in the climb even at a constant CAS. The LSS, being controlled by temperature, will also reduce. It can be seen from the formula that where $\text{Mach No} = \text{TAS} \div \text{LSS}$ an increase in TAS and a decrease in LSS must result in a marked increase in Mach No. A descent would mean a reversal of the speed changes seen in the climb.

Answer D

54 This question refers to the basic rules of magnetism; like poles repel, unlike poles attract and the lines of flux run from the red north seeking pole to the blue south seeking pole.

Answer C

55 Double integration means the second stage of integration, in this case distance along the local meridian.

Answer C

56 A solid state gyro refers to the ring laser gyro as used in Inertial Reference ('Strapdown') systems. It is also referred to as a rate sensor.

Answer B

57 Answer B

58 The ISA temperature at 40,000 ft is -56.5°C . Using the airspeed window of the CRP 5 set the temperature of -56.5° against the Mach number index. Now against the TAS of 450 kt on the outer scale read off the Mach number on the inner, 0.783.

Answer B

59 Answer A

60 Answer C

61 In an EFIS system wind information can be displayed in every mode except PLAN.

Answer C

62 Answer C

63 Answer B

64 In the NAV mode 1 dot = 2 nm, in the VOR mode 1 dot = 5° and in the ILS mode 1 dot = 1°

Answer C

65 Answer B

66 The apron is 10 ft below the stated aerodrome elevation, so assuming the QFE to be for the aerodrome level, an altimeter on the apron should read (-10) ft. However, the instrument is positioned in the aircraft 20 ft above the apron so it should show $(-10) + 20 = +10$ ft. Its actual reading is +40 ft so it is over-reading by 30 ft, an instrument error of +30 ft.

Answer B

SPECIMEN EXAMINATION PAPER

55 QUESTIONS TIME 1hr 30mins

- 1 An aircraft maintaining a constant CAS and altitude is flying from a cold airmass into warmer air. The effect of the change of temperature on the speed will be:
- 1 Mark
- a. CAS will increase
 - b. EAS will decrease
 - c. TAS will increase
 - d. TAS will decrease
- 2 Select the correct statement:
- 1 Mark
- a. EAS = CAS corrected for compressibility error
 - b. EAS = IAS corrected for position error
 - c. CAS = TAS corrected for density error
 - d. TAS = EAS corrected for compressibility error
- 3 V_{LO} is defined as:
- 1 Mark
- a. the maximum speed at which to fly with the landing gear retracted
 - b. the maximum speed at which the landing gear may be retracted or extended
 - c. the maximum speed at which to fly with the landing gear extended
 - d. the minimum speed at which to fly with the landing gear extended
- 4 An aircraft taking off from an airfield with QNH set in the altimeter has both static vents blocked by ice. As the aircraft climbs away the altimeter will:
- 1 Mark
- a. Read the airfield elevation
 - b. Indicate the aircraft height amsl
 - c. Read the height of the aircraft above the airfield
 - d. Show only a very small increase in height
- 5 In an inertial-lead VSI the source of the most pronounced error is:
- 1 Mark
- a. Instrument
 - b. Position
 - c. Steep turn
 - d. Missed approach manoeuvre
- 6 An aircraft is descending at a constant mach number. If the aircraft is descending through an inversion layer, the CAS will:
- 1 Mark
- a. Remain constant
 - b. Increase
 - c. Decrease
 - d. Decrease then decrease more slowly

- 7 The combined Machmeter/ASI is subject to the following errors:
- 1 Mark
- Position, density, instrument, compressibility, manoeuvre induced
 - Those of the Machmeter only
 - Instrument, pressure and temperature only
 - Instrument and compressibility only
- 8 You are flying at a constant FL 290 and constant mach number. The total temperature increases by 5°. The CAS will:
- 1 Mark
- remain approximately constant
 - increase by 10 kts
 - decrease by 10 kts
 - will increase or decrease depending on whether you are above or below ISA.
- 9 A factor giving an error on a direct indicating compass would be:
- 1 Mark
- crosswinds - particularly on east/west headings
 - parallax due to oscillations of the compass rose
 - acceleration on east/west headings
 - turning through east/west headings
- 10 If an aircraft, fitted with a DRMC, takes off on a westerly heading, in the northern hemisphere, the DRMC will indicate:
- 1 Mark
- a turn to the north
 - oscillates about west
 - no turn
 - a turn to south
- 11 To improve the horizontality of a compass, the magnet assembly is suspended from a point:
- 1 Mark
- On the centre line of the magnet
 - Below the centre of gravity
 - Above the centre of gravity
 - Varying with magnetic latitude
- 12 Which of the following will effect a direct reading compass?
- ferrous metals
 - non-ferrous metals
 - electrical equipment
- 2 Marks
- 1 only
 - 1 & 3
 - 1 & 2
 - all 3

- 13 The rigidity (gyroscopic inertia) of a gyroscope may be increased by:
- 1 Mark
- a. Increasing the number of gimbals and decreasing the number of planes of rotation
 - b. Increasing the speed of rotation and decreasing the mass of the rotor
 - c. Increasing the speed of rotation and increasing the mass of the rotor
 - d. Decreasing the speed of rotation and increasing the speed of the rotor.
- 14 The gravity erecting device on a vertical gyro is used on which instrument;
- 1 Mark
- a. directional gyro unit
 - b. turn indicator
 - c. artificial horizon
 - d. gyromagnetic device
- 15 If the rpm of the rotor in a turn and slip indicator is higher than normal, the turn indicator will:
- 1 Mark
- a. Overread the correct rate of turn
 - b. Underread the correct rate of turn
 - c. Not indicate due to the increased rigidity
 - d. Indicate correctly
- 16 When the pointer of a rate of turn indicator shows a steady rate of turn:
- 2 Marks
- a. The calibrated spring is exerting a force about the lateral axis equal to the rate of turn
 - b. The force produced by the spring is producing a precession equal to but
 - c. The spring is providing a force which produces a precession equal to the rate of turn (in the opposite direction to the turn)
 - d. The spring is providing a force which produces a precession equal to the rate of turn (in the same direction as the turn)
- 17 With reference to the flux valve of a remote indicating compass:
- 1 Mark
- a. The flux valve is pendulously mounted and is free to turn to remain aligned with the earth magnetic field
 - b. The flux valve is not subject to acceleration errors
 - c. The flux valve is pendulously mounted and so it is not subject to or affected by the earth's magnetic field
 - d. The flux valve is fixed to the aircraft and so turns with the aircraft to measure the angle between the aircraft and the earth's magnetic field
- 18 In a Schuler tuned INS, the largest unbounded errors are:
- 1 Mark
- a. Due to acceleration errors
 - b. Track errors due to initial misalignment
 - c. Due to real wander of the platform gyroscopes
 - d. Created at the first stage of integration

- 19 The amber ALERT sign is on an INS control and display unit:
- 1 Mark
- Illuminates steadily for 2 minutes before reaching the next waypoint
 - Start flashing 2 minutes before reaching the next waypoint and goes out at 30 seconds to run
 - Illuminates if power from the aircraft bus bar has been lost and the system is operating on standby battery
 - Illuminates steadily after passing a waypoint in manual mode, until the next leg is programmed in
- 20 To obtain heading information from a Gyro Stabilised platform, the gyros should have:
- 1 Mark
- 1 degree of freedom and a horizontal axis
 - 1 degree of freedom and a vertical axis
 - 2 degrees of freedom and a horizontal axis
 - 2 degrees of freedom and a vertical axis
- 21 What are the advantages of an IRS compared to an INS?
- 2 Marks
- Reduce spin-up time and a dither motor to prevent "lock-out".
 - Reduce spin-up time and accuracy not adversely affect by "g"
 - Increase accuracy and a dither motor to prevent "lock-out".
 - Insensitively to "g" and reduced wander of the gyroscope.
- 22 What errors can the Air Data Computer correct for?
- instrument error & ram rise
 - compressibility & density error
 - lag & density error
 - position & temperature error
 - temperature & instrument error
 - manoeuvre error & ram rise
 - manoeuvre & position errors
- 2 Marks
- 2 & 4
 - 1 & 6
 - 3 & 7
 - 3 & 5
- 23 Which of the following is the FMS normal operating condition in the cruise?
- 1 Mark
- L NAV only
 - V NAV only
 - L NAV or V NAV
 - L NAV and V NAV
- 24 Weather Radar returns can be displayed in which of the following EFIS Modes:
- 3 Marks
- | | | |
|---------|---------|---------|
| a. Plan | Exp ILS | Exp VOR |
| b. Plan | Exp ILS | Map |
| c. Map | Exp ILS | Exp VOR |
| d. Map | ILS | VOR |

- 25 What are the colours used on an EFIS display to show a tuned navigation aid and an airport?
- 2 Marks
- a. green & white
 - b. white & magenta
 - c. green & cyan
 - d. white & yellow
- 26 WXR display is on :
- 1 Mark
- a. The captains CRT only
 - b. The co-pilots CRT only
 - c. A special screen
 - d. On both the captains and co-pilots CRTs
- 27 Altitude select and altitude hold are examples of:
- 1 Mark
- a. Inner loop functions in pitch
 - b. Manometric functions from the ADC
 - c. Interlocking functions
 - d. Outer loop functions in roll
- 28 An autopilot delivers roll commands to the ailerons to achieve a bank angle:
- 1 Mark
- a. proportional to TAS, but below a specified maximum
 - b. set bank of 25 degrees
 - c. set bank of 30 degrees
 - d. proportional to the deviation from the desired heading, but not exceeding a specified maximum
- 29 At 200ft on an auto-land:
- 1 Mark
- a. The LOC mode is engaged in the roll channel and the G/S mode is engaged in pitch.
 - b. The LOC mode is engaged in the roll channel and the FLARE mode is engaged in the pitch channel
 - c. The ROLL OUT mode is engaged in the Roll channel and the G/S mode is engaged in pitch.
 - d. The auto-throttle is maintaining the speed and the pitch channel is maintaining the height.
- 30 During a CAT 1 ILS approach, height is indicated by:
- 1 Mark
- a. GPS
 - b. Radio Altimeter
 - c. Marker
 - d. Barometric

- 31 During an approach to autoland at 1500feet;
- 2 Marks
- Off line channels are manually engaged, flare mode is armed
 - Localiser is controlling the roll channel, off line channels are automatically engaged and flare mode is armed
 - Localiser is controlling the roll channel, stabiliser is trimmed nose up and roll out is armed
 - Provided both localiser and glideslope signals are valid LAND 3 will
- 32 During an autoland the caption LAND 2 is illuminated. The system is:
- 1 Mark
- Fail active or fail operational
 - Fail passive
 - Approaching decision height
 - Requiring a crew input
- 33 If only a single A/P is used to climb, cruise and approach; following a failure:
- 1 Mark
- it is fail passive with redundancy
 - it is fail operational and will not disconnect
 - it is fail soft and will not disconnect
 - it is fail safe and will disconnect
- 34 "LOC ARMED" lights up on the FMA part of the PFD, this means:
- 1 Mark
- localiser beam captured
 - localiser beam armed and awaiting capture
 - localiser alarm is on
 - a/c is on localiser centerline
- 35 What is the purpose of the auto-synchronisation system in an A/P:
- Prevents snatching on disengagement
 - Prevents snatching on engagement
 - Cross feeds rudder and aileron inputs for co-ordination
 - May not allow the A/P to engage if unserviceable
 - Displays the control positions
 - Removes standing demands from the autopilot system prior to the CMD button being selected
- 1 Mark
- 2,4&6
 - 1,3&5
 - 2,3&5
 - 1,4&6
- 36 What type of autoland system would be required for the landing to continue following a single failure below alert height?
- 1 Mark
- Fail soft
 - Fail passive
 - Fail operation or fail active
 - Land 2 system

- 37 Which of the following apply to the a Yaw damper :
1. May aid the pilot in the event of asymmetric thrust after engine failure
 2. Applies measured amounts of aileron to counter dutch roll
 3. Increases lateral stability to stop dutch roll
 4. Is required at high altitude
 5. Can automatically help in turn co-ordination
 6. May deflect the rudder to counteract the natural oscillating frequency of the aircraft.
- 1 Mark
- a. 1, 4 & 6
 - b. 2, 3 & 6
 - c. 2, 3 & 4
 - d. 1, 4 & 5
- 38 A stall warning system fitted to a large aircraft will always include:
- 1 Mark
- a. Various inputs including speed brake position, a warning module and a visual or aural warning
 - b. Various inputs including landing gear micro switch, a warning module and an aural warning
 - c. Various inputs including EGT, a warning module and an aural warning
 - d. Stick shakers and/or stick push
- 39 TCAS 2 when fitted with mode C transponder may give:
- 1 Mark
- a. TA only.
 - b. TA and RA in horizontal plane.
 - c. TA and RA in vertical plane.
 - d. RA only.
- 40 The Altitude Alert system alerts the pilot:
- 1 Mark
- a. At decision height
 - b. At the selected altitude
 - c. When reference altitude equals the selected altitude
 - d. When deviating from the selected altitude
- 41 The GPWS uses inputs from;
- 1 Mark
- a. The radio altimeter, static pressure monitor, ILS receiver and the landing gear and flap position monitors
 - b. The radio altimeter and the ILS receiver only
 - c. The radio altimeter, ILS receiver, static pressure monitor, and the landing gear position monitor only
 - d. The radio altimeter, static pressure monitor, landing gear position monitor, and the flap position monitor only

- 42 What are the components of a CVR
- 1 Microphone
 - 2 Crash/Fire resistant construction
 - 3 Independent battery
 - 4 A Flight data recorder
- 2 Marks
- a. 1 & 2
 - b. 1 & 4
 - c. 1, 2, 3 & 4
 - d. 1, 2 & 4
- 43 What corrective action is given by TCAS?
- 1 Mark
- a. Turn left or right.
 - b. Climb or descend.
 - c. Contact ATC
 - d. Turn then climb or descend.
- 44 What input is there to TCAS 2?
- 1 Mark
- a. Mode 'A' transponder which gives TA and RAs
 - b. Mode 'C' transponder which co-ordinates avoidance manoeuvres
 - c. Mode 'C' and 'S' transponders which co-ordinate avoidance manoeuvres
 - d. Mode 'S' transponder which co-ordinates avoidance manoeuvres
- 45 When an intruder aircraft has no Altitude Reporting facility, i.e. Mode equipped with 'A' transponder only, TCAS can only give:
- 1 Mark
- a. Corrective RA only
 - b. TA followed by a Preventative RA
 - c. TA only
 - d. Preventative RA only
- 46 Which of the following are modes of the GPWS?
1. Excessive sink rate.
 2. Altitude loss after T/O or go-around.
 3. Excessive Glideslope deviation.
 4. High climb rate.
 5. Flaps in incorrect position.
 6. High altitude descent.
 7. Stall.
- 2 Marks
- a. All 7
 - b. 1, 2, 3, & 5
 - c. 1, 2 & 3
 - d. 1, 3, 5 & 7

- 47 A warning message on the EICAS system screen would be:
- 1 Mark
- displayed in amber on the lower screen with associated caution lights and aural tones
 - displayed in amber, normally on the upper screen with aural warnings .
 - displayed in red, normally on the upper screen , and requiring immediate corrective action
 - displayed in amber, normally on the upper screen, indented one space to the right.
- 48 An aircraft equipped with digital avionics includes an ECAM system. This centralised system, if a failure in one of the monitored systems is displayed, the crew must:
- 2 Marks
- cancel the warning
 - analyse initially the failure and only respond to a level 1 warning
 - reset the warning display after noting the failure on the left screen
 - apply the immediate actions as directed by the checklist on the left of the two screens
- 49 An aircraft has a compensated capacitance fuel contents gauging system and is refuelled so that the total fuel contents are 76000kg at a temperature of 18°C and an S.G. of 0.81. Whilst the aircraft is parked the temperature increases to 26°C and the S.G. becomes 0.80. The indicated fuel contents have:
- 1 Mark
- increased by 10%
 - remained the same
 - increased by 5%
 - decreased by 5%
- 50 EPR is the ratio of;
- 1 Mark
- The compressor outlet pressure to the compressor inlet pressure
 - Jet pipe pressure to compressor inlet pressure on a turbo-prop engine only
 - Jet pipe pressure to the compressor inlet pressure on a gas turbine engine
 - Jet pipe pressure to the compressor outlet pressure on a gas turbine engine
- 51 If one probe of a multi-sensor EGT system became disconnected, the reading would:
- 1 Mark
- Increase by between 20°C to 30°C
 - Decrease by between 20°C to 30°C
 - Fall to zero
 - Be largely unaffected
- 52 The principle of the fuel-monitoring device giving an indication of the total fuel burnt is:
- 1 Mark
- multiplying flight time by fuel consumption
 - capacitance variation of a capacitor
 - difference of indication according to departure value
 - integration of instantaneous flow

- 53 The red arc in the middle of the green band of a piston engine RPM indicator signifies:
- 1 Mark
- a. Maximum RPM
 - b. Minimum RPM
 - c. RPM at which a greater level of vibration is encountered
 - d. RPM that must never be exceeded in the cruise
- 54 Torque meters provide a reliable measure of power output from:
- 1 Mark
- a. A turbo-jet engine
 - b. A noise suppression unit
 - c. A turbo-propeller engine
 - d. An APU
- 55 Which of the following types of pressure gauge would be best suited to a high pressure input?
- 1 Mark
- a. aneroid capsule
 - b. bourdon tube
 - c. bellows
 - d. dynamic probe

ANSWERS TO SPECIMEN EXAMINATION PAPER

(*w* = weighting/marks allocated for the question)

1	C	w 1	21	B	w 2	41	A	w 1
2	A	w 1	22	A	w 2	42	A	w 2
3	B	w 1	23	D	w 1	43	B	w 1
4	A	w 1	24	C	w 3	44	D	w 1
5	C	w 1	25	C	w 2	45	C	w 1
6	B	w 1	26	D	w 1	46	B	w 2
7	A	w 1	27	B	w 1	47	C	w 1
8	A	w 1	28	D	w 1	48	D	w 2
9	C	w 1	29	A	w 1	49	B	w 1
10	A	w 1	30	B	w 1	50	C	w 1
11	C	w 1	31	B	w 2	51	D	w 1
12	B	w 2	32	B	w 1	52	D	w 1
13	C	w 1	33	D	w 1	53	C	w 1
14	C	w 1	34	B	w 1	54	C	w 1
15	A	w 1	35	A	w 1	55	B	w 1
16	D	w 2	36	C	w 1			
17	D	w 1	37	A	w 1			
18	C	w 1	38	B	w 1			
19	A	w 1	39	C	w 1			
20	A	w 1	40	D	w 1			